







As you read this manual, you will find Information that is preceded by a symbol **NOTICE**. This information is intended to help you avoid damage to your vehicle, other property, or the environment.

Symbols   or   on labels attached to your vehicle are to remind you to read this owner's manual for proper and safe operation of your vehicle.

 or  is colour-coded to indicate "danger" (red), "warning" (amber), or "caution" (amber).

 **Safety Labels**  **P.91**

A Few Words About Safety

Your safety, and the safety of others, is very important. And operating this vehicle safely is an important responsibility.

To help you make informed decisions about safety, we have provided operating procedures and other information on labels and in this manual. This information alerts you to potential hazards that could hurt you or others.

Of course, it is not practical or possible to warn you about all the hazards associated with operating or maintaining your vehicle. You must use your own good judgement.

You will find this important safety information in a variety of forms, including:

- **Safety Labels** - on the vehicle.
- **Safety Messages** - preceded by a safety alert symbol  and one of three signal words: **DANGER**, **WARNING**, or **CAUTION**. These signal words mean:

 **DANGER**

You WILL be KILLED or SERIOUSLY HURT if you don't follow instructions.

 **WARNING**

You CAN be KILLED or SERIOUSLY HURT if you don't follow instructions.

 **CAUTION**

You CAN be HURT if you don't follow instructions.

- **Safety Headings** - such as Important Safety Precautions.
- **Safety Section** - such as Safe Driving.
- **Instructions** - how to use this vehicle correctly and safely.

This entire book is filled with important safety information - please read it carefully.

Event Data Recorders

Your vehicle is equipped with several devices commonly referred to as Event Data Recorders. They record various types of real time vehicle data such as SRS airbag deployment and SRS system components failure.

This data belongs to the vehicle owner and may not be accessed by anyone else except as legally required or with the permission of the vehicle owner.

However this data may be accessed by Honda, its authorised dealers and authorised repairers, employees, representatives and contractors only for the purpose of the technical diagnosis, research and development of the vehicle.

Service Diagnostic Recorders

Your vehicle is equipped with service-related devices that record information about powertrain performance and driving conditions. The data can be used to help technicians diagnose, repair and maintain the vehicle. This data may not be accessed by anyone else except as legally required or with the permission of the vehicle owner.

However this data may be accessed by Honda, its authorised dealers and authorised repairers, employees, representatives and contractors only for the purpose of the technical diagnosis, research and development of the vehicle.

This owner's manual should be considered a permanent part of the vehicle and should remain with the vehicle when it is sold.

This owner's manual covers all models of your vehicle. You may find descriptions of equipment and features that are not on your particular model.

Images throughout this owner's manual represent features and equipment that are available on some, but not all, models. Your particular model may not have some of these features.

The information and specifications included in this publication were in effect at the time of approval for printing. Honda Motor Co., Ltd. reserves the right, however, to discontinue or change specifications or design at any time without notice and without incurring any obligation.

➤ Safe Driving P. 35

For Safe Driving P. 36 Seat Belts P. 40 Airbags P. 52

➤ Instrument Panel P. 93

Indicators P. 94 Gauges and Displays P. 151

➤ Controls P. 169

Clock P. 170 Locking and Unlocking the Doors P. 173
Opening and Closing the Sunroof* P. 196
Adjusting the Seats P. 222

➤ Features P. 251

Audio System P. 252 Audio System Basic Operation P. 261, 286
Customized Features P. 359

➤ Driving P. 447

Before Driving P. 448 Towing a Trailer* P. 452 When Driving P. 458
Refueling P. 591 Fuel Economy and CO₂ Emissions P. 594

➤ Maintenance P. 597

Before Performing Maintenance P. 598 Service Reminder System* P. 601
Replacing Light Bulbs P. 634
Battery P. 656 Remote Transmitter Care P. 661
Accessories and Modifications P. 671

➤ Handling the Unexpected P. 673

Tools P. 674 If a Tyre Goes Flat P. 675
Overheating P. 699 Indicator, Coming On/Blinking P. 702
When You Cannot Unlock the Fuel Fill Door P. 719

➤ Information P. 723

Specifications P. 724 Identification Numbers P. 728

Contents

Child Safety P. 66

Exhaust Gas Hazard P. 90

Safety Labels P. 91

Opening and Closing the Boot P. 186

Security System P. 189

Opening and Closing the Windows P. 192

Operating the Switches Around the Steering Wheel P. 197

Adjusting the Mirrors P. 220

Interior Lights/Interior Convenience Items P. 231

Climate Control System P. 244

Audio Error Messages P. 350

General Information on the Audio System P. 353

Hands-Free Telephone System P. 394, 415

Braking P. 560

Parking Your Vehicle P. 578

Multi-View Rear Camera* P. 589

Fuel Economy and CO₂ Emissions P. 594

Turbo Engine Vehicle* P. 595

Maintenance Schedule P. 610

Maintenance Under the Bonnet P. 617

Checking and Maintaining Wiper Blades P. 646

Checking and Maintaining Tyres P. 649

Climate Control System Maintenance P. 663

Cleaning P. 666

Engine Does Not Start P. 692

Jump Starting P. 695

Shift Lever Does Not Move P. 698

Fuses P. 710

Emergency Towing P. 717

When You Cannot Open the Boot P. 720

Refueling P. 721

Utility Compliance* P. 729

EC Declaration of Conformity Content Outline* P. 732

Quick Reference Guide P. 4

Safe Driving P. 35

Instrument Panel P. 93

Controls P. 169

Features P. 251

Driving P. 447

Maintenance P. 597

Handling the Unexpected P. 673

Information P. 723

Index P. 733

Visual Index

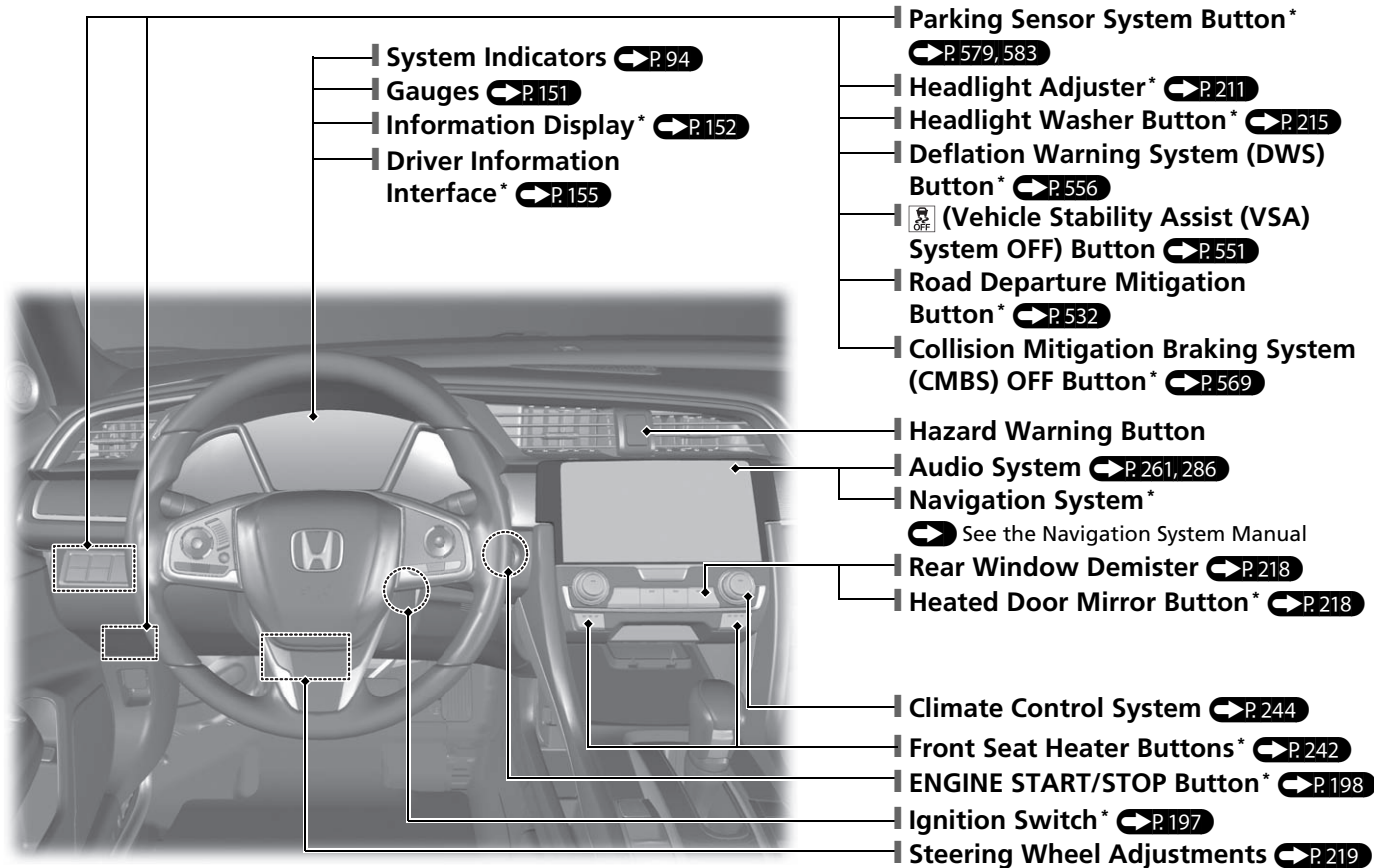

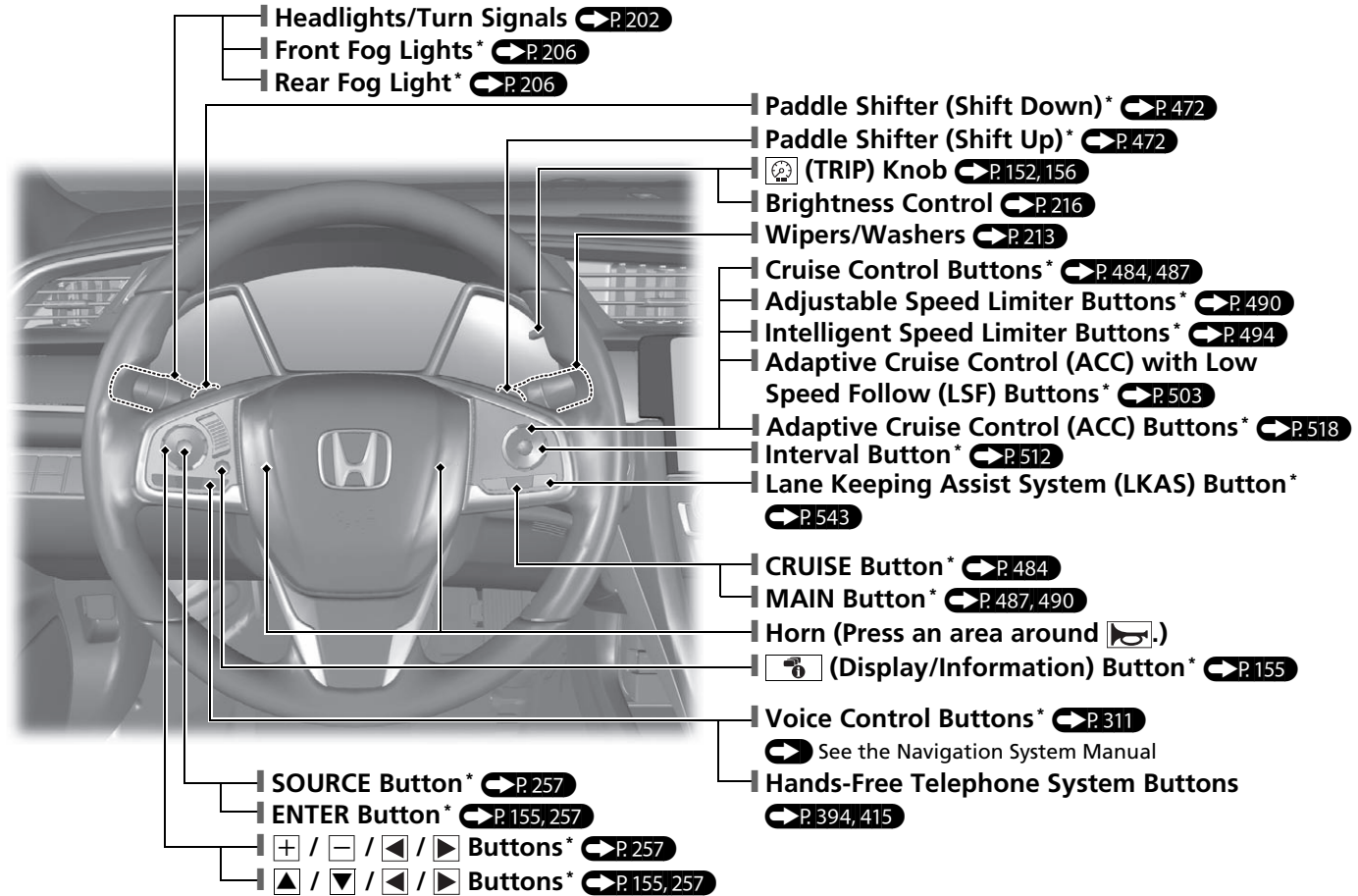

* Not available on all models

Visual Index

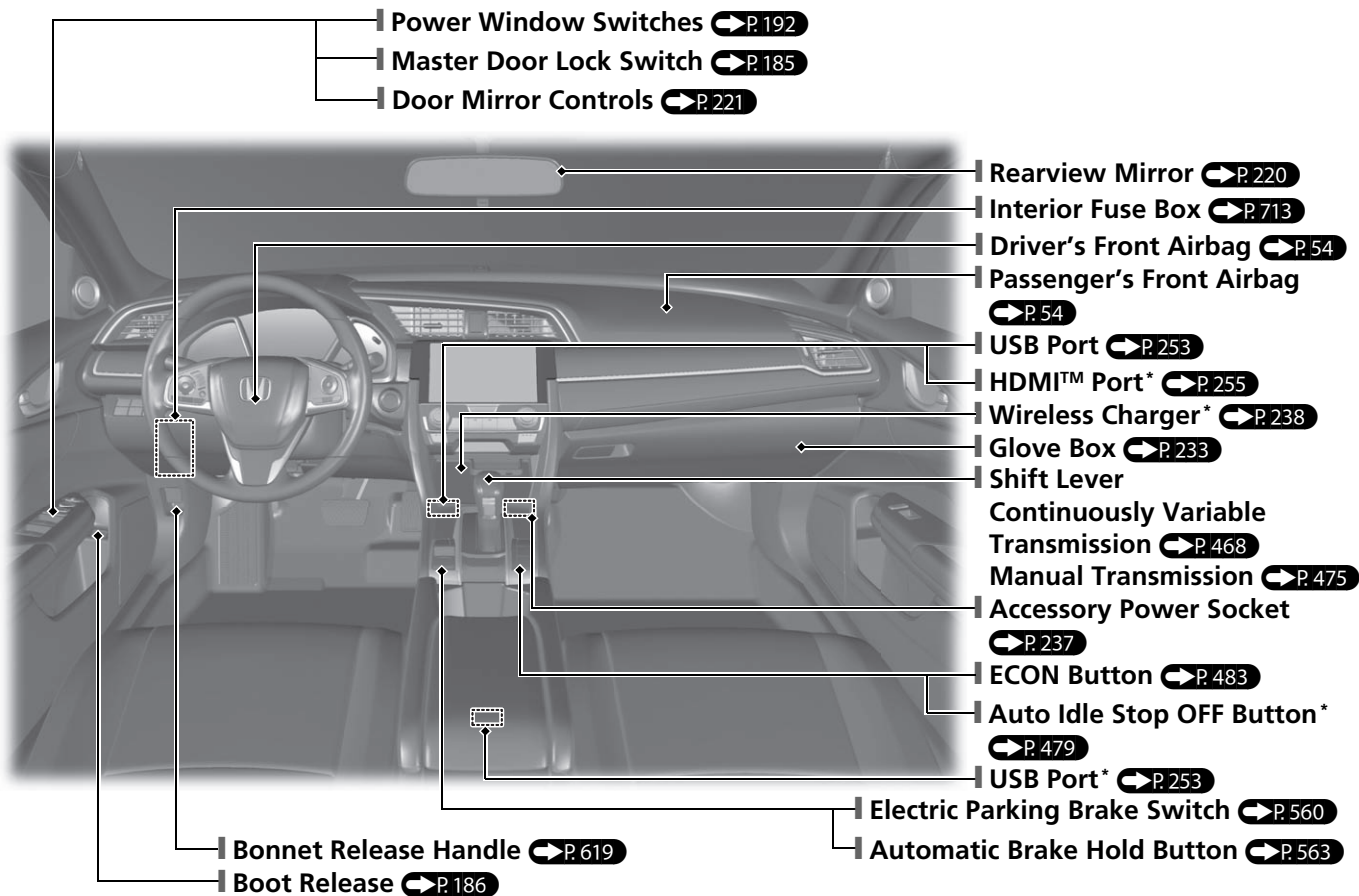

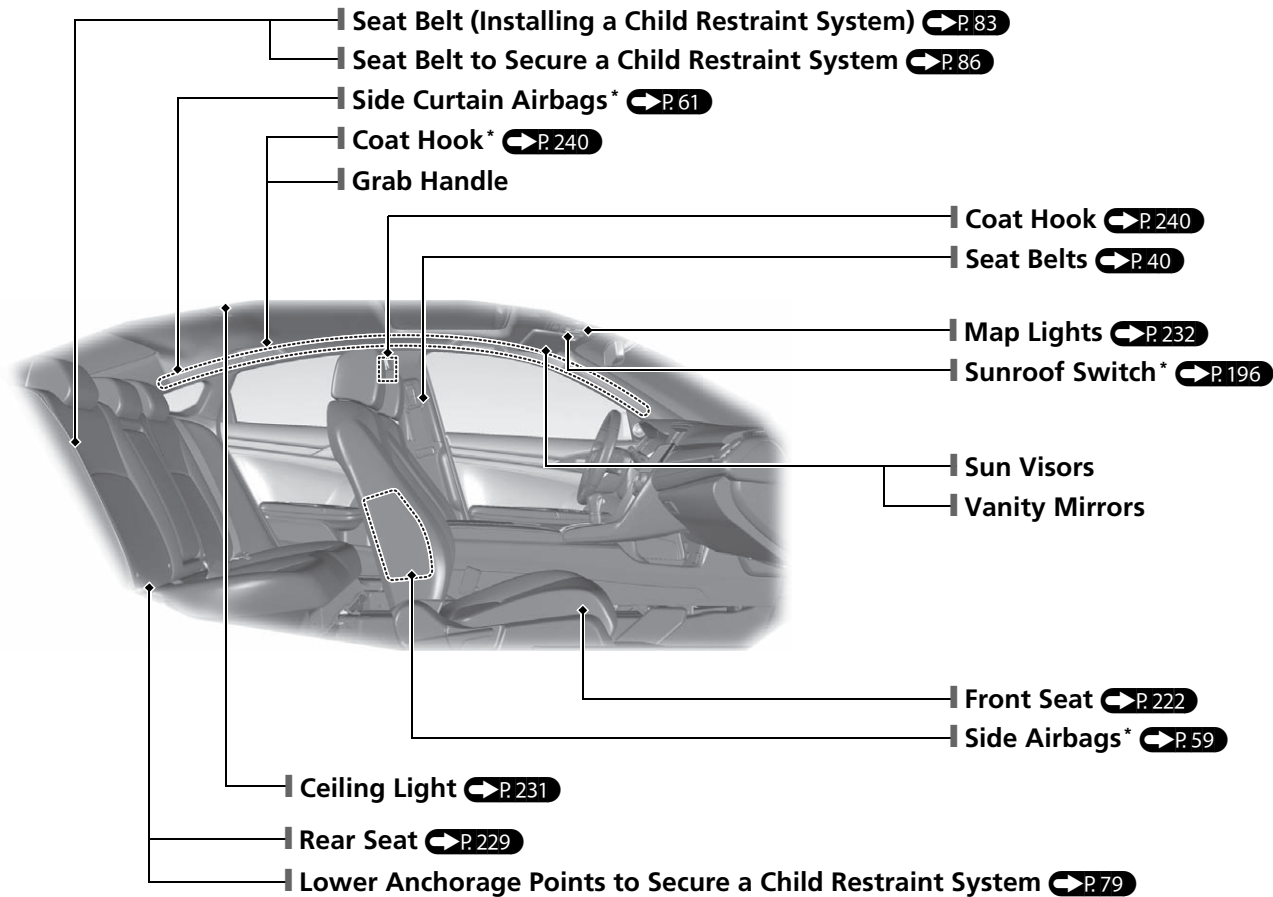

* Not available on all models

Visual Index

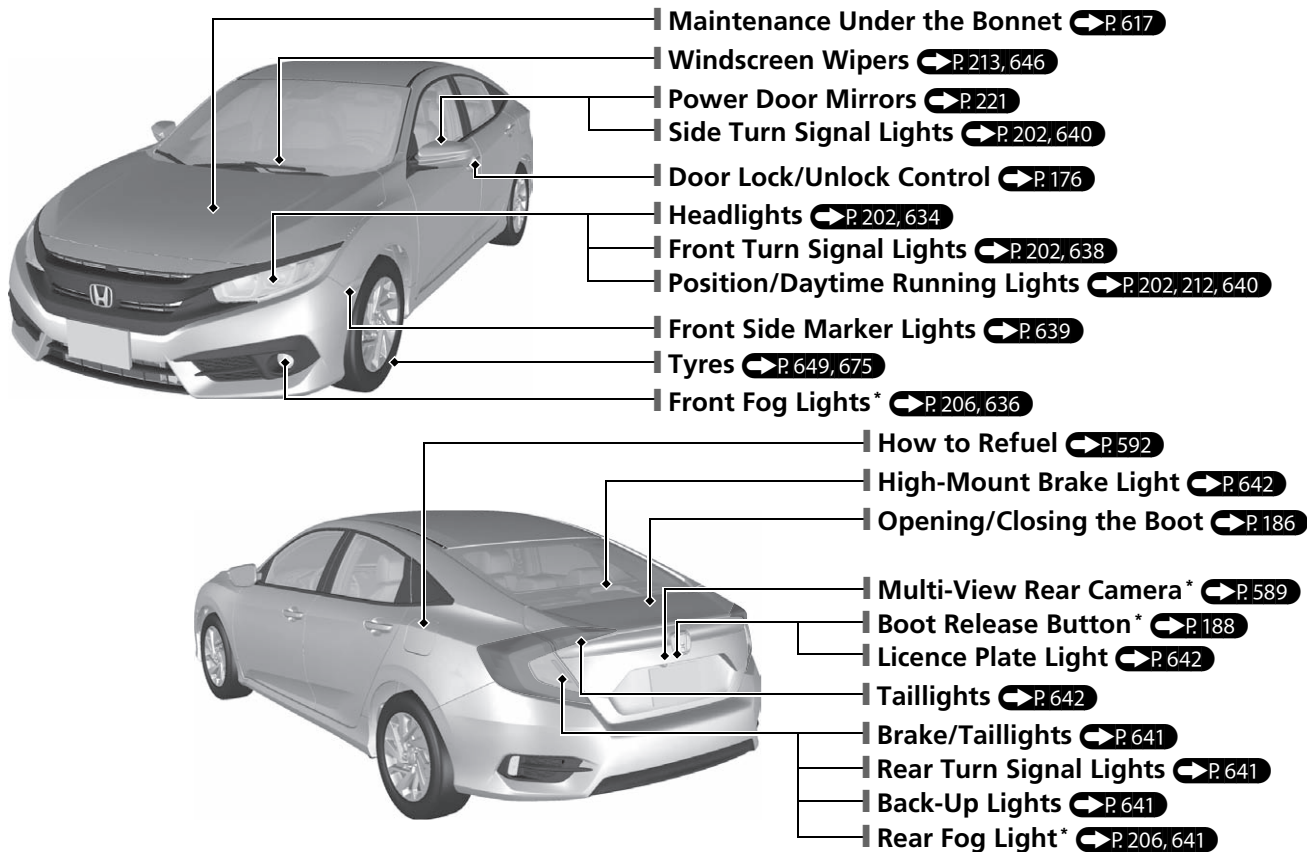

Eco Assist System

Ambient Meter

- Changes colour to reflect your driving style.
Green: Fuel efficient driving
White green: Moderate acceleration/ deceleration
White: Aggressive acceleration/ deceleration
- The ambient meter colour changes in accordance with your brake or accelerator pedal operation.

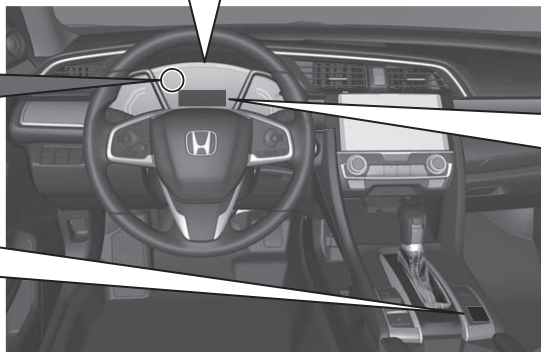

ECON Button ➔ P. 483
Helps maximise fuel economy.

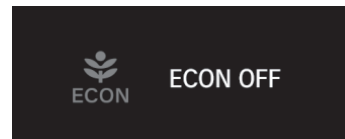
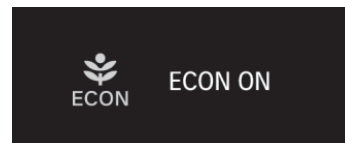

ECON Mode Indicator ➔ P. 111
Comes on when the ECON button is pressed.



Models with driver information interface
The message is displayed for a few seconds when the ECON button is pressed.

Auto Idle Stop Function

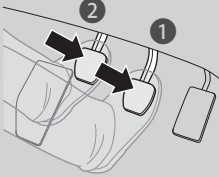
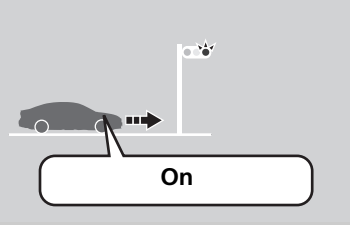
To improve fuel economy, the engine stops and then restarts as detailed below. When Auto Idle Stop is on, the Auto Idle Stop indicator (green) comes on. 

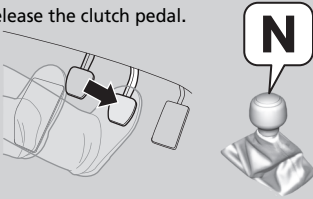
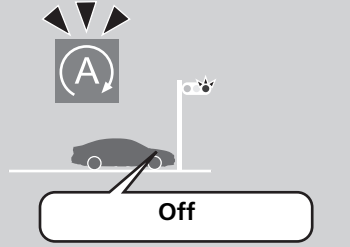
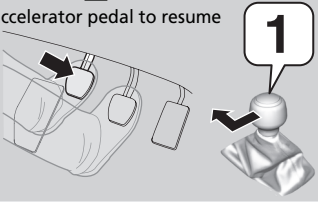
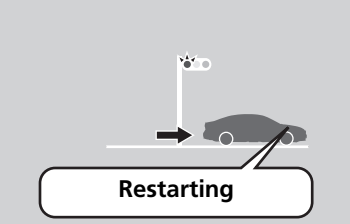
At	Manual transmission	Engine status
<p>Deceleration</p> 	<p>1. Depress the brake pedal. 2. Fully depress the clutch pedal.</p> 	 <p>On</p>
<p>Stop</p> 	<ul style="list-style-type: none">• Continue to depress the brake pedal.• Move the shift lever to N.• Release the clutch pedal. 	 <p>Off</p>
<p>Start-up</p>	<ul style="list-style-type: none">• Depress the clutch pedal again.• Move the shift lever to 1.• Depress the accelerator pedal to resume driving. 	 <p>Restarting</p>

Safe Driving P.35

Airbags P.52

- Your vehicle is fitted with airbags to help to protect you and your passengers during a moderate-to-severe collision.

Child Safety P.66

- All children 12 and younger should be seated in the rear seat.
- Small children should be properly restrained in a front facing child restraint system.
- Infants must be properly restrained in a rear-facing child restraint system on a rear seat.

Exhaust Gas Hazard P.90

- Your vehicle emits dangerous exhaust gases that contain carbon monoxide. Do not run the engine in confined spaces where carbon monoxide gas can accumulate.

Seat Belts P.40

- Fasten your seat belt and sit upright well back in the seat.
- Check that your passengers are wearing their seat belts correctly.

Before Driving Checklist P.448

- Before driving, check that the front seats, head restraints, steering wheel, and mirrors have been properly adjusted.



Fasten your lap belt as low as possible.













Instrument Panel ↔ P. 93

Gauges ↔ P. 151 / Information Display* ↔ P. 152 /

Driver Information Interface* ↔ P. 155 / System Indicators ↔ P. 94



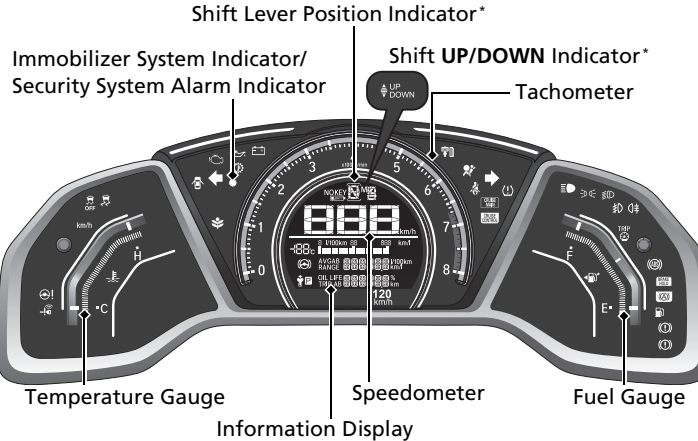

Models with information display

System Indicators

-  Malfunction Indicator Lamp
-  Low Oil Pressure Indicator
-  Low Oil Level Indicator*
-  Charging System Indicator
-  Anti-lock Brake System (ABS) Indicator
-  Vehicle Stability Assist (VSA) System Indicator
-  VSA OFF Indicator
-  Door and Boot Open Indicator
-  ECON Mode Indicator
-  Parking Brake and Brake System Indicator (Red)
-  Parking Brake and Brake System Indicator (Amber)
-  Keyless Access System Indicator*
-  Low Tyre Pressure/Deflation Warning System Indicator*















System Indicators

-  Electric Power Steering (EPS) System Indicator
-  Turn Signal and Hazard Warning Indicators
-  Transmission Temperature Indicator*
-  Light Control Indicator*













Lights Indicators

-  Lights On Indicator
-  High Beam Indicator
-  Front Fog Light Indicator*
-  Rear Fog Light Indicator*

System Indicators

-  Low Fuel Indicator
-  Seat Belt Reminder Indicator
-  Supplemental Restraint System Indicator
-  **CRUISE MAIN** Indicator
-  **CRUISE CONTROL** Indicator
-  **120 km/h** Speed Alarm Indicator*
-  Starter System Indicator*
-  **BRAKE HOLD** Automatic Brake Hold System Indicator
-  **(A)** Automatic Brake Hold Indicator
-  **P** Shift to Park Indicator*
-  Continuously variable transmission models Brake Depressing Indicator
-  Manual transmission models Brake Depressing Indicator
-  Rotate Wheel Indicator*

System Indicators

-  Malfunction Indicator Lamp
-  Low Oil Pressure Indicator
-  Charging System Indicator
-  Anti-lock Brake System (ABS) Indicator
-  Vehicle Stability Assist (VSA) System Indicator
-  VSA OFF Indicator
-  Door and Boot Open Indicator
-  Automatic Brake Hold System Indicator
-  Automatic Brake Hold Indicator
-  ECON Mode Indicator
-  Parking Brake and Brake System Indicator (Red)
-  Parking Brake and Brake System Indicator (Amber)

Shift Lever Position



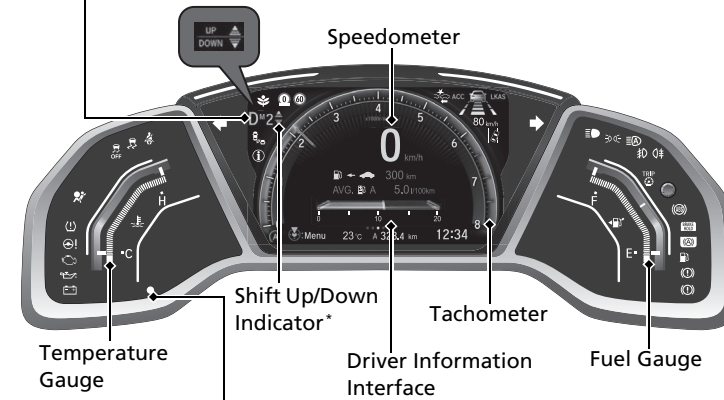

Indicator*

Shift UP/DOWN Indicator*





Temperature Gauge













Lights Indicators

-  Lights On Indicator
-  High Beam Indicator
-  Front Fog Light Indicator
-  Rear Fog Light Indicator*

System Indicators

- ACC** Adaptive Cruise Control (ACC) with Low Speed Follow (LSF) Indicator (Amber/Green)*
-  Road Departure Mitigation Indicator*
-  Collision Mitigation Braking System (CMBS) Indicator*
- LKAS** Lane Keeping Assist System (LKAS) Indicator (Amber/Green)*
-  Blind Spot Information (BSI) Indicator*

System Indicators

-  System Message Indicator
-  Low Tyre Pressure/Deflation Warning System Indicator*
-  Turn Signal and Hazard Warning Indicators
-  Electric Power Steering (EPS) System Indicator
-  Low Fuel Indicator
-  Seat Belt Reminder Indicator
-  Supplemental Restraint System Indicator
-  **CRUISE MAIN** Indicator*
-  **CRUISE CONTROL** Indicator*
-  Auto Idle Stop Indicator (Green)*
-  Auto Idle Stop System Indicator (Amber)*
-  Auto High-Beam Indicator*





* Not available on all models

Controls P.169

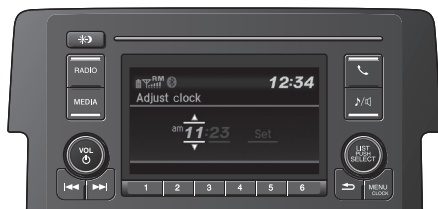
Clock P.170

Models with colour audio system



- 1 Press and hold the **MENU/CLOCK** button.
- 2 Rotate  to change hour, then press .
- 3 Rotate  to change minute, then press .
- 4 Select **Set**, then press .



These indications are used to show how to operate the selector knob.

- Rotate  to select.
- Press  to enter.

Models with Display Audio





The audio system receives signals from GPS satellites, updating the clock automatically.



- 1 Select the  (HOME) icon, then select **Settings**.
- 2 Select **Clock**, then **Clock Adjustment**.
- 3 Touch the respective  /  icon to adjust the hours or minutes up or down.
- 4 Select **OK**.

Models without audio system



- 1 Press the  button to select , then press the **ENTER** button.
- 2 Press the  button until **Clock Setup** appears on the display.
- 3 Press the **ENTER** button.
- 4 Press the **ENTER** button to select **Adjust Clock**.
- 5 Press the  button to change hour, then press the **ENTER** button.
- 6 Press the  button to change minute, then press the **ENTER** button.

ENGINE START/STOP Button* P.198

- Press the button to change the vehicle's power mode.



Turn Signals P.202

Turn Signal Control Lever

Right

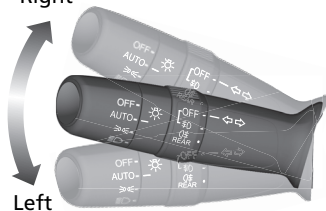

Left

Lights P.202

Light Control Switches

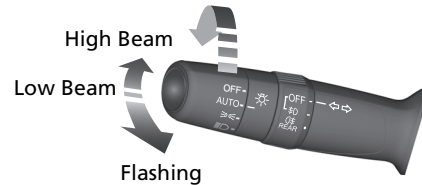

Wipers and Washers

➔ P.213

Wiper/Washer Control Lever

Adjustment Ring*

- ☐: Low sensitivity*¹
- ☐: Lower speed, fewer sweeps*²
- ☐: High sensitivity*¹
- ☐: Higher speed, more sweeps*²

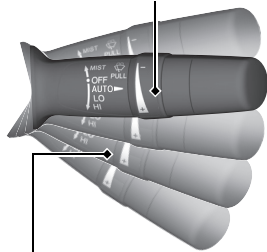

Pull towards you to spray washer fluid.

MIST
OFF

AUTO*¹: Wiper speed varies automatically
INT*²: Low speed with intermittent
LO: Low speed wipe
HI: High speed wipe

*1: Models with automatic intermittent wipers

*2: Models without automatic intermittent wipers

Models with automatic intermittent wipers

AUTO should always be turned **OFF** before cleaning the windscreen or driving through a car wash.

Steering Wheel ➔ P.219

- To adjust, pull the adjustment lever towards you, adjust to the desired position, then lock the lever back in place.



Unlocking the Front Doors from the Inside

➔ P.184

- Pull either front door inner handle to unlock and open it at the same time.

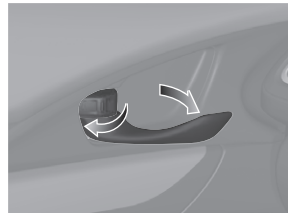

Boot ➔ P.186

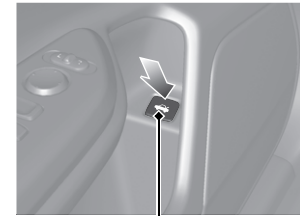

Boot Release Button

- To unlock and open the boot:
 - Press the boot release button on the driver's door.
 - Press the boot release button on the remote transmitter or the keyless remote.
 - Press the boot release button* on the boot lid, with carrying the keyless remote.

Power Door Mirrors

➔ P. 221

- With the ignition switch in ON **II***1, move the selector switch to **L** or **R**.
- Push the appropriate edge of the adjustment switch to adjust the mirror.
- Press the fold button* to fold in and out the door mirrors.

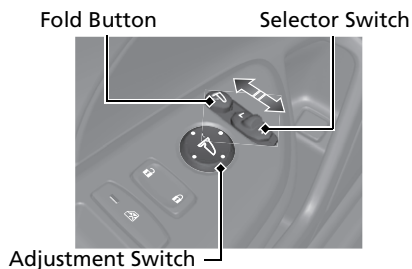

*1: Models with the keyless access system have an **ENGINE START/STOP** button instead of an ignition switch.

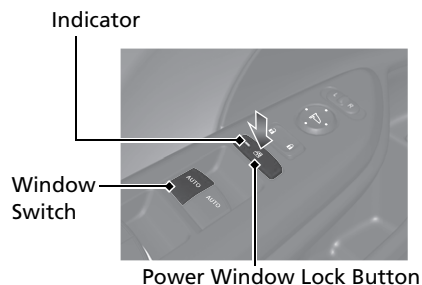

Power Windows ➔ P. 192

- With the ignition switch in ON **II***1, open and close the power windows.
- If the power window lock button is in the off position, each passenger's window can be opened and closed with its own switch.
- If the power window lock button is in the on position (indicator is on), each passenger's window switch is disabled.







*1: Models with the keyless access system have an **ENGINE START/STOP** button instead of an ignition switch.

Climate Control System P.244

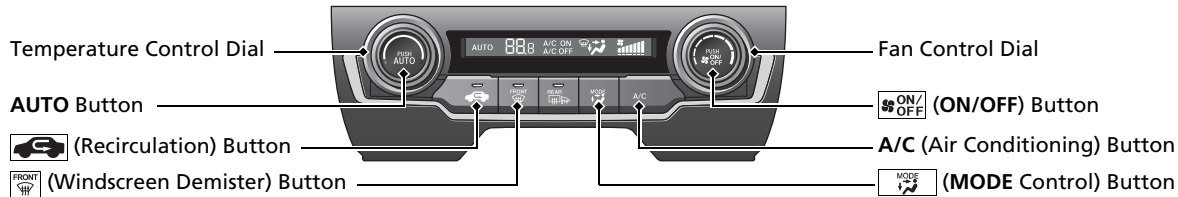
- Press the **AUTO** button to activate the climate control system.
- Press the  button to turn the system on or off.
- Press the  button to defrost the windscreen.

Models with colour audio system



-  Air flows from floor and windscreen demister vents.
-  Air flows from floor vents.
-  Air flows from floor and dashboard vents.
-  Air flows from dashboard vents.

Models with Display Audio
Models without SYNC button



Audio/Information Screen

 (CLIMATE) Button

Temperature Control Dial

AUTO Button





 (Recirculation) Button

 (Fresh Air) Button

 (Windscreen Demister) Button

 (ON/OFF) Button

Fan Control Dial

-  Air flows from floor and windscreen demister vents.
-  Air flows from floor vents.
-  Air flows from floor and dashboard vents.
-  Air flows from dashboard vents.

Models with Display Audio

Models with SYNC button



(CLIMATE) Button

Driver side Temperature Control Dial

AUTO Button



(ON/OFF) Button



(Recirculation) Button



(Windscreen Demister) Button

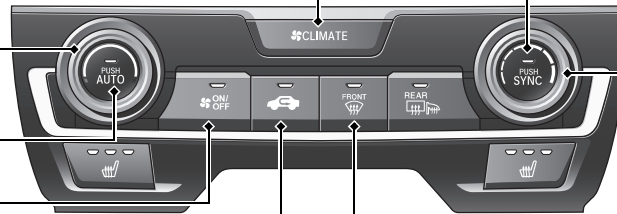

SYNC (Synchronized) Button

Passenger side Temperature Control Dial



Air flows from floor and windscreen demister vents.



Air flows from floor vents.



Air flows from floor and dashboard vents.



Air flows from dashboard vents.

Features ↔ P.251

Audio Remote Controls

↔ P.257

Models with information display

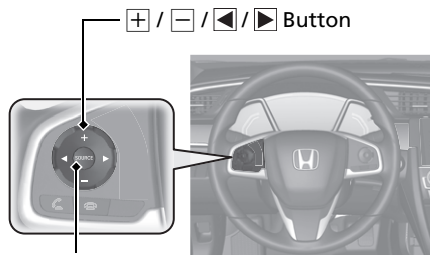

SOURCE Button

- **+ / -** Button
Press to adjust the volume up/down.
- **SOURCE** Button
Press to change the audio mode: FM1/ FM2/DAB1*/DAB2*/LW*/AM (MW*)/USB/ iPod/Bluetooth® Audio.
- **▲ / ▼** Button
Radio: Press to change the preset station.
Press and hold to select the next or previous strong station.
USB device:
Press to skip to the beginning of the next song or return to the beginning of the current song.
Press and hold to change a folder.

Models with driver information interface

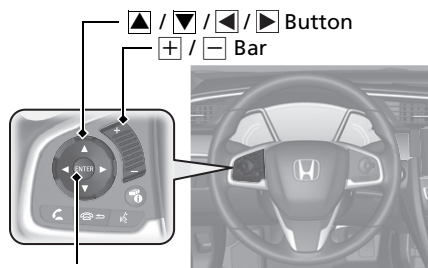

ENTER Button

- **+ / -** Bar
Models with Display Audio
Press to adjust the volume up/down.
Sliding up or down also increases or decreases the volume.
Swipe down quickly to mute the volume or swipe up to cancel the mute.
- **▲ / ▼** Button
Press **▲** or **▼** to cycle through the audio mode as follows:

Models with colour audio system

FM1→FM2→DAB1*→DAB2*→LW→AM (MW*)→USB→iPod→Bluetooth® Audio

Models with Display Audio







FM→DAB*→LW*→AM→MW*→USB→iPod →Bluetooth® Audio→Apps*→ Audio Apps*→AUX-HDMI™

Models with Display Audio

- **ENTER** Button
- When listening to the radio
 - 1 Press **ENTER** to switch the display to a preset list you stored in the preset buttons.
 - 2 Press **▲** or **▼** to select a preset, then press **ENTER**.
- When listening to a USB flash drive
 - 1 Press **ENTER** to display the folder list.
 - 2 Press **▲** or **▼** to select a folder.
 - 3 Press **ENTER** to display a list of tracks in that folder.
 - 4 Press **▲** or **▼** to select a track, then press **ENTER**.



You can also swipe up or down to scroll through the list of tracks alphabetically.

- When listening to an iPod

- 1 Press **ENTER** to display the iPod music list.
- 2 Press  or  to select a category.
- 3 Press **ENTER** to display a list of items in the category.
- 4 Press  or  to select an item, then press **ENTER**.
 - ▶ Press **ENTER** and press  or  repeatedly until a desired item you want to listen is displayed.

You can also swipe up or down to scroll through the list of tracks alphabetically.

- When listening to *Bluetooth*® Audio

- 1 Press **ENTER** to display the track list.
- 2 Press  or  to select a track, then press **ENTER**.

-  /  Button

Radio: Press to change the preset station.
Press and hold to select the next or previous strong station.



USB device:

Press to skip to the beginning of the next song or return to the beginning of the current song.
Press and hold to change a folder.



Button:

Press to change contents.

 **Driver Information Interface***  P. 155

Audio system P. 252

Models with colour audio system  P. 261

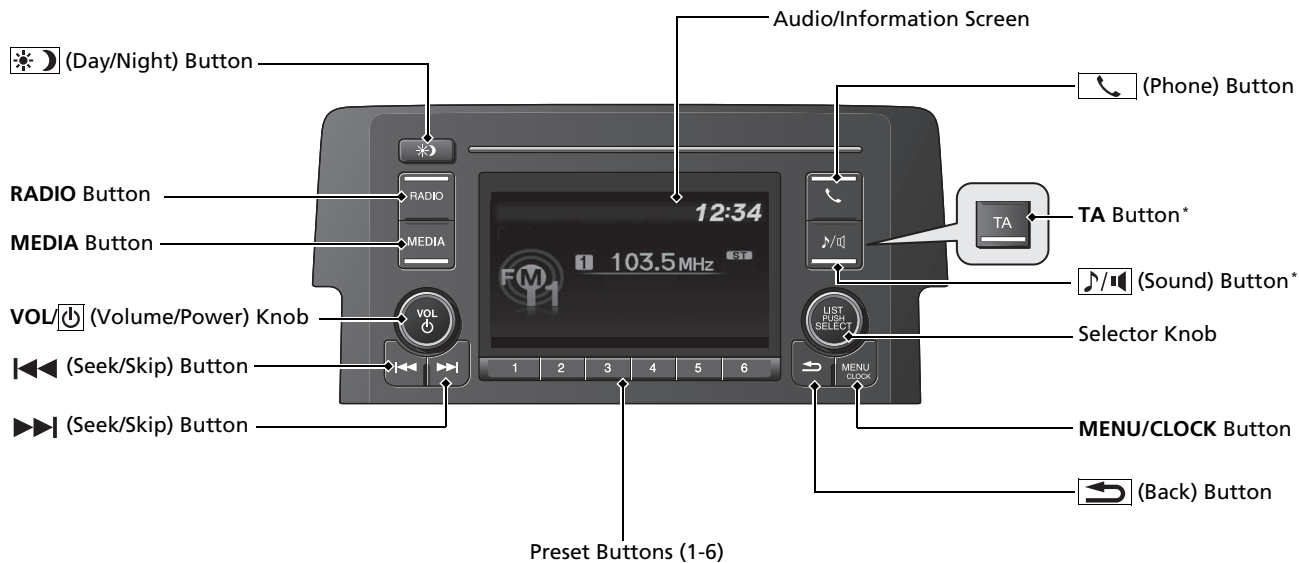

* Not available on all models

For navigation system operation See the Navigation System Manual

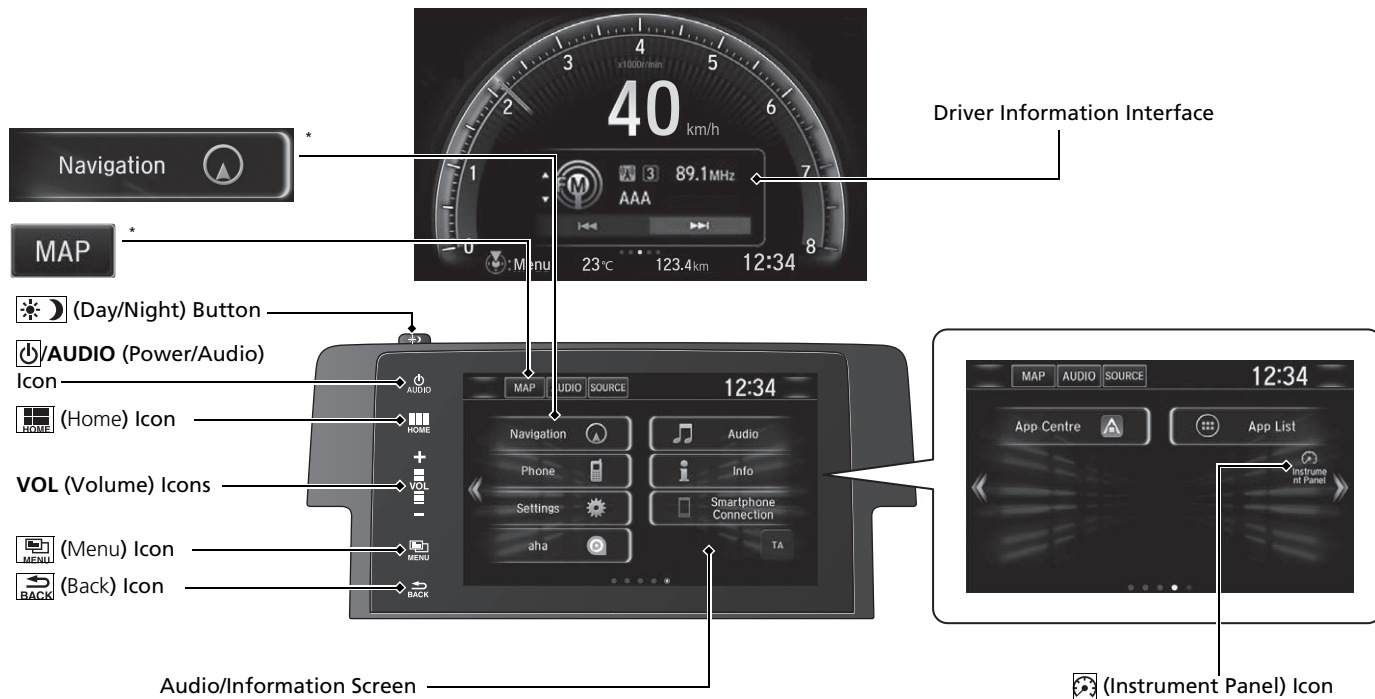

Driving ↔ P. 447

Manual Transmission* ↔ P. 475

Continuously Variable Transmission*

↔ P. 468, 470

- Shift to **P** and depress the brake pedal when starting the engine.

Shifting

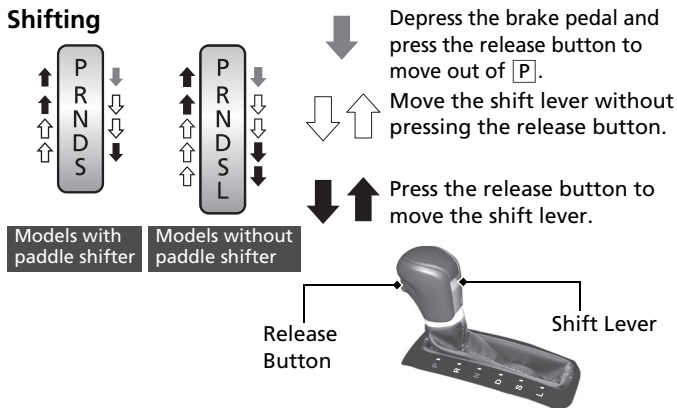

P **Park**
Turn off or start the engine.
Transmission is locked.

R **Reverse**
Used when reversing.

N **Neutral**
Transmission is not locked.

D **Drive**
● Normal driving.
● On models with paddle shifter, 7-speed mode can be used temporarily.

S **Drive (S)**
● Better acceleration.
● Increased engine braking.
● Going up or down hills.
● On models with paddle shifter, 7-speed manual shift mode can be used.

L **Low***
● Further increased engine braking.
● Going up or down hills.

Paddle Shifters* ↔ P. 472

- Paddle shifters allow you to shift gears much like a manual transmission (1st through 7th). This is useful for engine braking.
- D-paddle shift mode: The transmission will shift back to automatic mode once the system detects that the vehicle is cruising.
- Sequential shift mode: Holds the selected gear, and the **M** indicator comes on.

Shift Lever Position Indicator

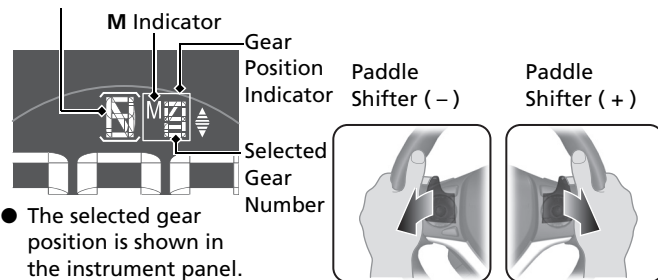

- The selected gear position is shown in the instrument panel.



* Not available on all models

VSA On and Off Button

➔ P. 551

- The vehicle stability assist (VSA) system helps to stabilise the vehicle during cornering, and helps to maintain traction while accelerating on loose or slippery road surfaces.
- VSA comes on automatically every time you start the engine.
- To partially disable or fully restore VSA function, press and hold the button until you hear a beep.

Cruise Control* ➔ P. 484, 487

- Cruise control allows you to maintain a set speed without keeping your foot on the accelerator pedal.

Models without adjustable speed limiter

- To use cruise control, press the **CRUISE** button, then press **-/SET** once you have achieved the desired speed (above 40 km/h).

Models with adjustable speed limiter

- To use cruise control, press the **MAIN** button. Select cruise control by pressing the **LIM** button, then press **-/SET** once you have achieved the desired speed (above 30 km/h).

Adjustable Speed

Limiter* ➔ P. 490

- This system enables you to set a maximum speed that cannot be exceeded even if you are depressing the accelerator pedal.
- To use the adjustable speed limiter, press the **MAIN** button. Select the adjustable speed limiter by pressing the **LIM** button, then press the **-/SET** when your vehicle reaches the desired speed.
- The vehicle speed limit can be set from 30 km/h to 250 km/h.

CMBS On and Off ➔ P. 569

- When a possible collision is likely unavoidable, the CMBS can help you to reduce the vehicle speed and the severity of the collision.
- To turn the CMBS on or off, press and hold the button until you hear a beep.

Except Egyptian models

Deflation Warning System (DWS) ➔ P. 556

- Detects a change in tyre conditions and overall dimensions due to decrease in tyre pressures.
- Deflation warning system is turned on automatically every time you start the engine.
- A calibration procedure must be performed when certain conditions arise.

Refueling P.591

Fuel recommendation: 1.6 L engine models for Middle Eastern except Israeli and Turkish
Unleaded petrol, research octane number 91 or higher

1.6 L engine models for Israeli, Turkish, and except Middle Eastern
Unleaded premium petrol, research octane number 95 or higher

1.5 L engine models
Unleaded premium petrol/gasohol up to E10 (90% petrol and 10% ethanol), research octane number 95 or higher

Fuel tank capacity: 46.9 L

- 1** Press the edge of the fuel fill door to make it pop up slightly.
- 2** After refueling, wait for about five seconds before removing the filler nozzle.

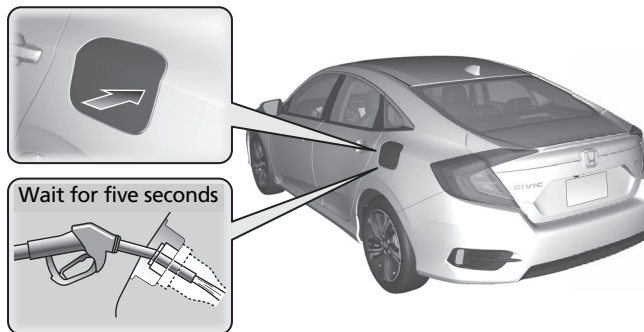

Maintenance P.597

Under the Bonnet P.617

- Check engine oil, engine coolant, and washer fluid. Add when necessary.
- Check brake fluid and clutch fluid*.
- Check the battery condition monthly.

- 1 Pull the bonnet release handle under the corner of the dashboard.

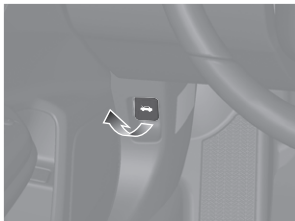

- 2 Locate the bonnet latch lever, pull it up, and then raise the bonnet. Once you have raised the bonnet slightly, you can release the lever.



- 3 When finished, close the bonnet and make sure it is firmly locked in place.

Wiper Blades P.646

- Replace blades if they leave streaks across the windscreen.

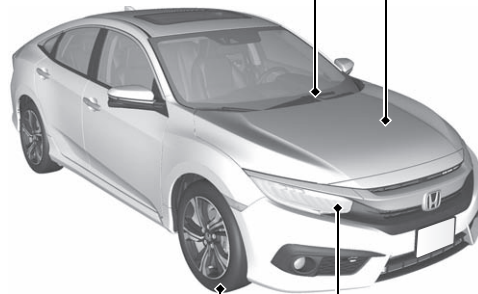

Tyres P.649

- Inspect tyres and wheels regularly.
- Check tyre pressures regularly.
- Install winter tyres for winter driving.

Lights P.634

- Inspect all lights regularly.

Handling the Unexpected P.673

Flat Tyre P.675

Models with a spare tyre

- Park in a safe location and replace the flat tyre with the spare tyre in the boot.

Models with tyre repair kit

- Park in a safe place and repair the flat tyre using the tyre repair kit.



Indicators Come On

P.702

- Identify the indicator and consult the owner's manual.

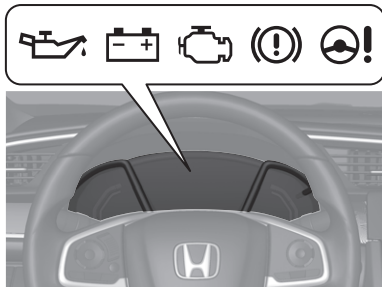

Engine Won't Start P.692

- If the battery is dead, jump start using a booster battery.

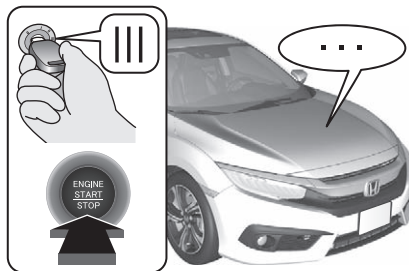

Blown Fuse P.710

- Check for a blown fuse if an electrical device does not operate.

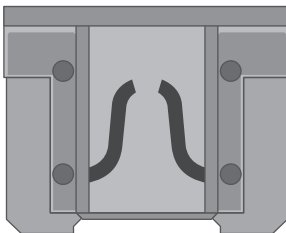

Overheating P.699

- Park in a safe location. If you do not see steam under the bonnet, open the bonnet, and let the engine cool down.



Emergency Towing P.717

- Call a professional towing service if you need to tow your vehicle.



What to Do If



Models without keyless access system

The ignition switch does not turn from **0** to **I**. Why?

Models with keyless access system

The power mode does not change from **VEHICLE OFF (LOCK)** to **ACCESSORY**. Why?



The steering wheel may be locked.

Models without keyless access system

Try to turn the steering wheel left and right while turning the ignition key.

Models with keyless access system

Move the steering wheel left and right after pressing the **ENGINE START/STOP** button.



Models without keyless access system

The ignition switch does not turn from **I** to **0** and I cannot remove the key. Why?

Models with keyless access system

The power mode does not change from **ACCESSORY** to **VEHICLE OFF (LOCK)**. Why?



The shift lever should be moved to **P**.



Why does the brake pedal pulsate slightly when applying the brakes?



This can occur when the ABS activates and does not indicate a problem. Apply firm, steady pressure on the brake pedal. Never pump the brake pedal.

Q The rear door cannot be opened from inside the vehicle. Why?

A Check if the childproof lock is in the lock position. If so, open the rear door with the outside door handle. To cancel this function, slide the lever up to the unlock position.

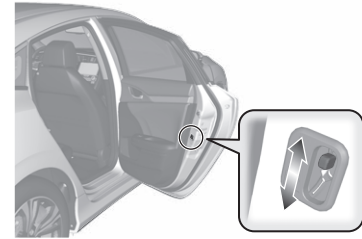

Q Why do the doors lock after I unlocked the doors?

A If you do not open a door within 30 seconds, the doors are relocked automatically for security.

Q Why does the beeper sound when I open the driver's door?

A The beeper sounds when:

- The exterior lights are left on.
- The Auto Idle Stop* is in operation.

Models without keyless access system

- The key is left in the ignition switch.

Models with keyless access system

- The power mode is in ACCESSORY.

Q Why does the beeper sound when I start driving?

A The beeper sounds when the driver and/or front passenger* are not wearing their seat belts.

Q Pressing the electric parking brake switch does not release the parking brake. Why?

A Press the electric parking brake switch with the brake pedal depressed.

Q Depressing the accelerator pedal does not release the parking brake automatically. Why?

A

- Fasten the driver's seat belt.
- **Continuously variable transmission models**
Check if the transmission is in **P** or **N**. If so, select any other position.

Manual transmission models

- Check if the transmission is in **N**. If so, select any other position.
 - Depress the clutch pedal fully. Then, while gently depressing the accelerator pedal, gradually release the clutch pedal.
-

Q Why do I hear a screeching sound when I apply the brake pedal?

A The brake pads may need to be replaced. Have your vehicle inspected by a dealer.

Q

Israeli, Turkish, and except Middle Eastern models

Is it possible to use unleaded petrol with a Research Octane Number (RON) of 91 or higher on this vehicle?

A

Your vehicle is designed to operate on premium unleaded petrol with a research octane of 95 or higher. If this octane grade is unavailable, regular unleaded petrol with a research octane of 91 or higher may be used temporarily.

The use of regular unleaded petrol can cause metallic knocking noises in the engine and will result in decreased engine performance. The long-term use of regular-grade petrol can lead to engine damage.

Safe Driving

You can find many safety recommendations throughout this chapter, and throughout this manual.

For Safe Driving

Important Safety Precautions.....	36
Your Vehicle's Safety Features.....	38
Safety Checklist	39

Seat Belts

About Your Seat Belts.....	40
Fastening a Seat Belt.....	46
Seat Belt Inspection.....	50
Anchorage Points.....	51

Airbags

Airbag System Components.....	52
Types of Airbags	54

Front Airbags (SRS)	54
Side Airbags*	59
Side Curtain Airbags*	61
Airbag System Indicators.....	63
Airbag Care	65

Child Safety

Protecting Child Passengers	66
Safety of Infants and Small Children...	69
Safety of Larger Children	87

Exhaust Gas Hazard

Carbon Monoxide Gas.....	90
--------------------------	----

Safety Labels

Label Locations	91
-----------------------	----

* Not available on all models

The following pages explain your vehicle's safety features and how to use them properly. The safety precautions below are ones that we consider to be among the most important.

Important Safety Precautions

■ Always wear your seat belt

A seat belt is your best protection in all types of collisions. Airbags are designed to supplement seat belts, not replace them. So even though your vehicle is equipped with airbags, make sure you and your passengers always wear your seat belts, and wear them properly.

■ Restrain all children

Children aged 12 and under should ride properly restrained in a back seat, not the front seat. Infants and small children should be restrained in a child restraint system. Larger children should use a booster seat and a lap/shoulder seat belt until they can use the belt properly without a booster seat.

■ Be aware of airbag hazards

While airbags can save lives, they can cause serious or fatal injuries to occupants who sit too close to them, or are not properly restrained. Infants, young children, and short adults are at the greatest risk. Be sure to follow all instructions and warnings in this manual.

■ Don't drink and drive

Alcohol and driving don't mix. Even one drink can reduce your ability to respond to changing conditions, and your reaction time gets worse with every additional drink. So don't drink and drive, and don't let your friends drink and drive, either.

⊗ Important Safety Precautions

Some countries prohibit the use of mobile phones other than hands-free devices by the driver while driving.

■ **Pay appropriate attention to the task of driving safely**

Engaging in mobile phone conversation or other activities that keep you from paying close attention to the road, other vehicles, and pedestrians could lead to a crash. Remember, situations can change quickly, and only you can decide when it is safe to divert some attention away from driving.

■ **Control your speed**

Excessive speed is a major factor in crash injuries and deaths. Generally, the higher the speed, the greater the risk, but serious injuries can also occur at lower speeds. Never drive faster than is safe for current conditions, regardless of the maximum speed posted.

■ **Keep your vehicle in safe condition**

Having a tyre blowout or a mechanical failure can be extremely hazardous. To reduce the possibility of such problems, check your tyre pressures and condition frequently, and perform all regularly scheduled maintenance.

Your Vehicle's Safety Features

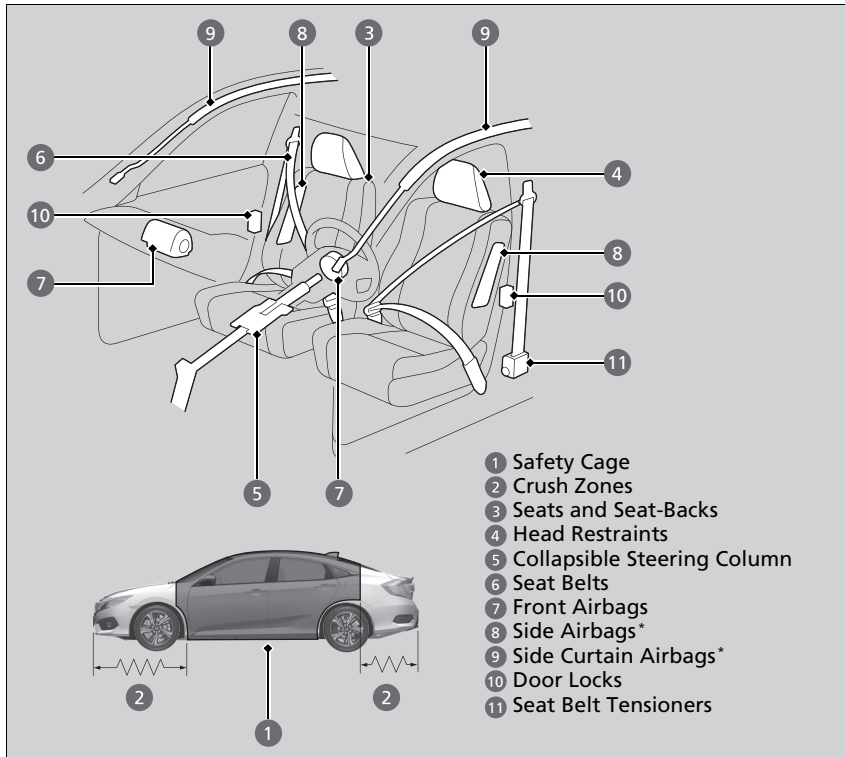

The following checklist will help you take an active role in protecting yourself and your passengers.

►► Your Vehicle's Safety Features

Your vehicle is equipped with many features that work together to help to protect you and your passengers during a crash.

Some features do not require any action on your part. These include a strong steel framework that forms a safety cage around the passenger compartment, front and rear crush zones, a collapsible steering column, and tensioners that tighten the front seat belts in a sufficient crash.

However, you and your passengers cannot take full advantage of these features unless you remain seated in the correct position and always wear your seat belts. In fact, some safety features can contribute to injuries if they are not used properly.

Safety Checklist

For the safety of you and your passengers, make a habit of checking these items each time before you drive.

- **Locking/Unlocking the Doors from the Inside** P. 184

 - Adjust your seat to a position suitable for driving. Be sure the front seats are adjusted as far to the rear as possible while allowing the driver to control the vehicle. Sitting too close to a front airbag can result in serious or fatal injury in a crash.
 - **Adjusting the Seats** P. 222
- Adjust head restraints to the proper position. Head restraints are most effective when the centre of the head restraint aligns with the centre of your head. Taller persons should adjust their head restraint to the highest position.
- **Adjusting the Front Head Restraints** P. 226
- Always wear your seat belt, and make sure you wear it properly. Confirm that any passengers are properly belted as well.
- **Fastening a Seat Belt** P. 46
- Protect children by using seat belts or child restraint systems according to a child's age, height and weight.
- **Child Safety** P. 66

* Not available on all models

► Safety Checklist

Models with information display

If the door/boot open indicator is on, a door and/or the boot is not completely closed. Close all doors tightly until the indicator goes off.

➤ **Door and Boot Open Indicator*** P. 105

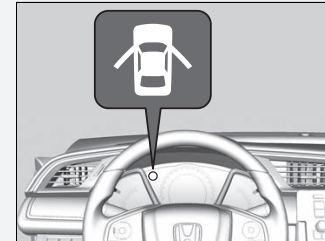

Models with driver information interface

If the door and boot open message appears on the driver information interface, a door and/or the boot is not completely closed. Close all doors and the boot tightly until the message disappears.

➤ **Driver Information Interface Warning and Information Messages*** P. 126

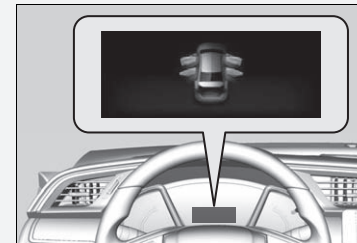

About Your Seat Belts

Seat belts are the single most effective safety device because they keep you connected to the vehicle so that you can take advantage of many built-in safety features. They also help to keep you from being thrown against the inside of the vehicle, against any passengers, or out of the vehicle. When worn properly, seat belts also keep your body properly positioned in a crash so that you can take full advantage of the additional protection provided by the airbags.

In addition, seat belts help to protect you in almost every type of crash, including:

- frontal impacts
- side impacts
- rear impacts
- rollovers

>About Your Seat Belts

WARNING

Not wearing a seat belt properly increases the chance of serious injury or death in a crash, even though your vehicle has airbags.

Be sure you and your passengers always wear seat belts and wear them properly.

WARNING: Seat belts are designed to bear upon the bony structure of the body, and should be worn low across the front of the pelvis or the pelvis, chest and shoulders, as applicable; wearing the lap section of the belt across the abdominal area must be avoided.

WARNING: Seat belts should be adjusted as firmly as possible, consistent with comfort, to provide the protection for which they have been designed. A slack belt will greatly reduce the protection afforded to the wearer.

WARNING: Belts should not be worn with straps twisted.

WARNING: Each belt assembly must only be used by one occupant; it is dangerous to put a belt around a child being carried on the occupant's lap.

■ Lap/shoulder seat belts

All five seating positions are equipped with lap/shoulder seat belts with emergency locking retractors. In normal driving the retractor lets you move freely while keeping some tension on the belt. During a collision or sudden stop the retractor locks to restrain your body.

Models with lockable retractor seat belts

The front passenger's* and rear seat belts also have a lockable retractor for use with child restraint systems.

➤ **Installing a Child Restraint System with a Lap/Shoulder Seat Belt** P. 83

⌘ About Your Seat Belts

The emergency locking retractor may lock if you lean forward too quickly. Slower movements will allow the belt to extend fully without locking.

Seat belts cannot completely protect you in every crash. But in most cases, seat belts can reduce your risk of serious injury.

Most countries require you to wear seat belts. Take time to familiarise with the legal requirements of the countries in which you will drive.

* Not available on all models

■ Proper use of seat belts

Follow these guidelines for proper use:

- All occupants should sit upright, well back in the seat, and remain in that position for the duration of the trip. Slouching and leaning reduce the effectiveness of the belt and can increase the chance of serious injury in a crash.
- Never place the shoulder part of a lap/shoulder seat belt under your arm or behind your back. This could cause very serious injuries in a crash.
- Two people should never use the same seat belt. If they do, they could be very seriously injured in a crash.
- Do not put any accessories on the seat belts. Devices intended to improve comfort or reposition the shoulder part of a seat belt can reduce the protective capability and increase the chance of serious injury in a crash.

» About Your Seat Belts

Models with lockable retractor seat belts

If a rear seat passenger moves around and extends the seat belt, the lockable retractor may activate. If this happens, release the retractor by unfastening the seat belt and allow the belt to retract completely. Then refasten the belt.

Seat Belt Reminder

Front seats

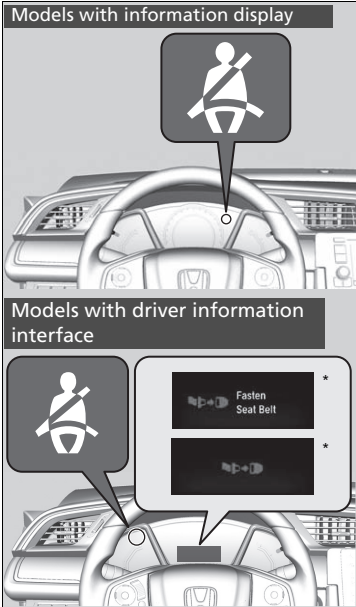

The seat belt system includes an indicator on the instrument panel to remind the driver or a front passenger or both to fasten their seat belts.

If the ignition switch is turned to ON *1 and a seat belt is not fastened, a beeper will sound and the indicator will blink. After a few seconds, the beeper will stop and the indicator will come on and remain illuminated until the seat belt is fastened.

The beeper will periodically sound and the indicator will blink while the vehicle is moving until the seat belt is fastened.

Seat Belt Reminder

The indicator will also come on if a front passenger does not fasten their seat belt within six seconds after the ignition switch is turned to ON *1.

When no one is sitting in the front passenger's seat, the indicator will not come on and the beeper will not sound.

If the indicator comes on or the beeper sounds with no one sitting in the front passenger's seat. Check if:

- There is nothing heavy placed on the front passenger seat.
- The driver's seat belt is fastened.

If the indicator does not light when the passenger is seated and is not fastened, something may be interfering with the occupant detection sensor. Check if:

- A cushion is placed on the seat.
- The front passenger is not sitting properly.

If none of these conditions exist, have your vehicle checked by a dealer.

*1: Models with the keyless access system have an **ENGINE START/STOP** button instead of an ignition switch.

* Not available on all models

■ Rear seats*

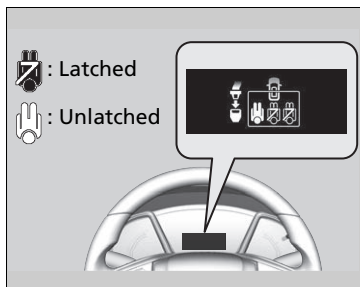

Your vehicle monitors rear seat belt use. A driver information interface notifies you if any of the rear seat belts are used.

The display appears when:

- A rear door is opened or closed.
- Any of the rear passengers latches or unlatches their seat belt.

The beeper sounds if any rear passenger's seat belt is unlatched while driving.

To see the display:

Press the  (display/information) button.

Automatic Seat Belt Tensioners

The front seats are equipped with automatic seat belt tensioners to enhance safety.

The tensioners automatically tighten the front seat belts during a moderate-to-severe frontal collision, sometimes even if the collision is not severe enough to inflate the front airbags.

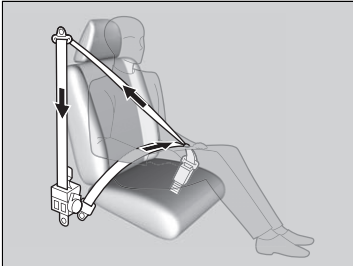

Automatic Seat Belt Tensioners

The seat belt tensioners can only operate once. If a tensioner is activated, the SRS indicator will come on. Have a dealer replace the tensioner and thoroughly inspect the seat belt system as it may not offer protection in a subsequent crash.

Models with side curtain airbags

During a moderate-to-severe side impact, the tensioner on that side of the vehicle also activates.

Fastening a Seat Belt

After adjusting a front seat to the proper position, and while sitting upright and well back in the seat:

▶ Adjusting the Seats P. 222

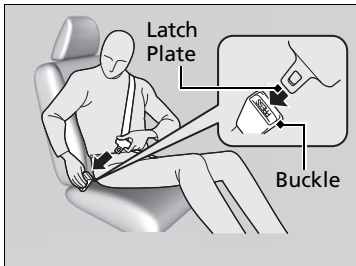
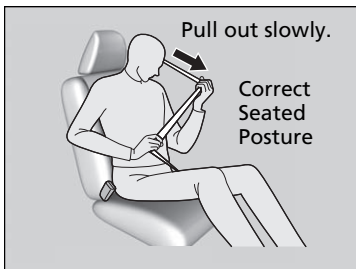

1. Pull the seat belt out slowly.

2. Insert the latch plate into the buckle, then tug on the belt to make sure the buckle is secure.

▶ Make sure that the belt is not twisted or caught on anything.

▶▶ Fastening a Seat Belt

No one should sit in a seat with an inoperative seat belt or one that does not appear to be working correctly. Using a seat belt that is not working properly may not protect the occupant in a crash. Have a dealer check the belt as soon as possible.

Never insert any foreign objects into the buckle or retractor mechanism.

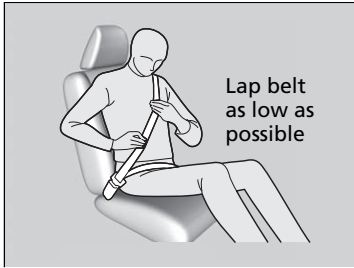

3. Position the lap part of the belt as low as possible across your hips, then pull up on the shoulder part of the belt so the lap part fits snugly. This lets your strong pelvic bones take the force of a crash and reduces the chance of internal injuries.
4. If necessary, pull up on the belt again to remove any slack, then check that the belt rests across the centre of your chest and over your shoulder. This spreads the forces of a crash over the strongest bones in your upper body.

Fastening a Seat Belt

⚠ WARNING

Improperly positioning the seat belts can cause serious injury or death in a crash.

Make sure all seat belts are properly positioned before driving.

To release the belt, push the red **PRESS** button then guide the belt by hand until it has retracted completely.

When exiting the vehicle, be sure the belt is out of the way and will not get caught by closing the door.

■ Adjusting the Shoulder Anchor

The front seats have adjustable shoulder anchors to accommodate taller and shorter occupants.

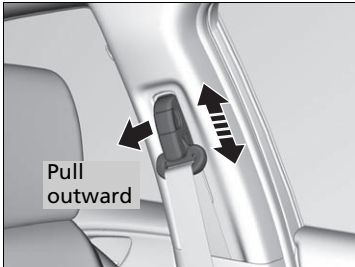

1. Move the anchor up and down while pulling the release outward.
2. Position the anchor so that the belt rests across the centre of your chest and over your shoulder.

▣ Adjusting the Shoulder Anchor

The shoulder anchor height can be adjusted to four levels. If the belt contacts your neck, lower the height one level at a time.

After an adjustment, make sure that the shoulder anchor position is secure.

Advice for Pregnant Women

If you are pregnant, the best way to protect yourself and your unborn child when driving or riding in a vehicle is to always wear a seat belt and keep the lap part of the belt as low as possible across the hips.

Wear the shoulder belt across the chest avoiding the abdomen.



Wear the lap part of the belt as low as possible across the hips.

Advice for Pregnant Women

Each time you have a checkup, ask your doctor if it is okay for you to drive.

To reduce the risk of injuries to both you and your unborn child that can be caused by an inflating front airbag:

- When driving, sit upright and adjust the seat as far back as possible while allowing full control of the vehicle.
- When sitting in the front passenger's seat, adjust the seat as far back as possible.

Seat Belt Inspection

Regularly check the condition of your seat belts as follows:

- Pull each belt out fully, and look for frays, cuts, burns, and wear.
- Check that the latch plates and buckles work smoothly and the belts retract easily.
 - ▶ If a belt does not retract easily, cleaning the belt may correct the problem. Only use a mild soap and warm water. Do not use bleach or cleaning solvents. Make sure the belt is completely dry before allowing it to retract.

Any belt that is not in good condition or working properly will not provide proper protection and should be replaced as soon as possible.

A belt that has been worn during a crash may not provide the same level of protection in a subsequent crash. Have your seat belts inspected by a dealer after any collision.

▶▶ Anchorage Points

WARNING

Not checking or maintaining seat belts can result in serious injury or death if the seat belts do not work properly when needed.

Check your seat belts regularly and have any problem corrected as soon as possible.

WARNING: No modifications or additions should be made by the user which will either prevent the seat belt adjusting devices from operating to remove slack, or prevent the seat belt assembly from being adjusted to remove slack.

WARNING: It is essential to replace the entire assembly after it has been worn in a severe impact even if damage to the assembly is not obvious.

WARNING: Care should be taken to avoid contamination of the webbing with polishes, oils and chemicals, and particularly battery acid. Cleaning may safely be carried out using mild soap and water. The belt should be replaced if webbing becomes frayed, contaminated or damaged.

Anchorage Points

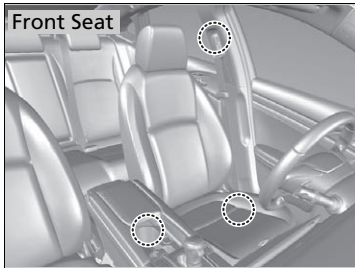

When replacing the seat belts, use the anchorage points shown in the images. The front seat has a lap/shoulder belt.

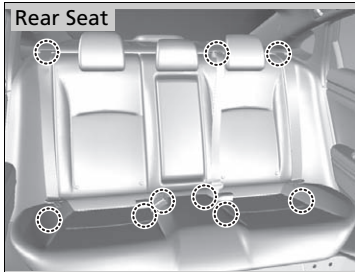

The rear seat has three lap/shoulder belts.

Airbag System Components

The front, front side*, and side curtain airbags* are deployed according to the direction and severity of impact. The airbag system includes:

- Two SRS (Supplemental Restraint System) front airbags. The driver's airbag is stored in the centre of the steering wheel; the front passenger's airbag is stored in the dashboard. Both are marked **SRS AIRBAG**.

Models with side airbags

- Two side airbags, one for the driver and one for a front passenger. The airbags are stored in the outer edges of the seat-backs. Both are marked **SIDE AIRBAG**.

Models with side curtain airbags

- Two side curtain airbags, one for each side of the vehicle. The airbags are stored in the ceiling, above the side windows. The front and rear pillars are marked **SIDE CURTAIN AIRBAG**.

- An electronic control unit that, when the vehicle is on, continually monitors information about the sensors, the airbag activators, the seat belt tensioners, passenger front airbag off indicator, passenger front airbag ON/OFF switch and driver's seat belt. During a crash event the unit can record such information.
- Automatic front seat belt tensioners.

Models without side airbags

- Impact sensors that can detect a moderate-to-severe front impact.

Models with side airbags

- Impact sensors that can detect a moderate-to-severe front or side impact.
- An indicator on the instrument panel that alerts you to a possible problem with your airbag system or seat belt tensioners.
- An indicator on the instrument panel that alerts you that the front passenger's side airbag has been turned off.

Models with passenger front airbag off system

- An indicator on the dashboard that alerts you that the passenger's front airbag has been turned off.

Important Facts About Your Airbags

Airbags can pose serious hazards. To do their job, airbags must inflate with tremendous force. So, while airbags help to save lives, they can cause burns, bruises, and other minor injuries, sometimes even fatal ones if occupants are not wearing their seat belts properly and sitting correctly.

What you should do: Always wear your seat belt properly, and sit upright and as far back from the steering wheel as possible while allowing full control of the vehicle. A front passenger should move their seat as far back from the dashboard as possible.

Remember, however, that no safety system can prevent all injuries or deaths that can occur in a severe crash, even when seat belts are properly worn and the airbags deploy.

Do not place hard or sharp objects between yourself and a front airbag.

Carrying hard or sharp objects on your lap, or driving with a pipe or other sharp object in your mouth, can result in injuries if your front airbag inflates.

Do not attach or place objects on the front airbag covers. Objects on the covers marked **SRS AIRBAG** could interfere with the proper operation of the airbags or be propelled inside the vehicle and hurt someone if the airbags inflate.

Important Facts About Your Airbags

Do not attempt to deactivate your airbags. Together, airbags and seat belts provide the best protection.

When driving, keep hands and arms out of the deployment path of the front airbag by holding each side of the steering wheel. Do not cross an arm over the airbag cover.

Types of Airbags

Your vehicle is equipped with three types of airbags:

- **Front airbags:** Airbags in front of the driver's and front passenger's seats.
- **Side airbags*:** Airbags in the driver's and front passenger's seat-backs.
- **Side curtain airbags*:** Airbags above the side windows.

Each is discussed in the following pages.

Front Airbags (SRS)

The front SRS airbags inflate in a moderate-to-severe frontal collision to help to protect the head and chest of the driver and/or front passenger.

SRS (Supplemental Restraint System) indicates that the airbags are designed to supplement seat belts, not replace them. Seat belts are the occupant's primary restraint system.

Housing Locations

The front airbags are housed in the centre of the steering wheel for the driver, and in the dashboard for the front passenger. Both airbags are marked **SRS AIRBAG**.

Types of Airbags

The airbags can inflate whenever the ignition switch is in ON *1.

After an airbag inflates in a crash, you may see a small amount of smoke. This is from the combustion process of the inflator material and is not harmful. People with respiratory problems may experience some temporary discomfort. If this occurs, get out of the vehicle as soon as it is safe to do so.

* 1: Models with the keyless access system have an **ENGINE START/STOP** button instead of an ignition switch.

■ Operation

Front airbags are designed to inflate during moderate-to-severe frontal collisions. When the vehicle decelerates suddenly, the sensors send information to the control unit which signals one or both front airbags to inflate.

A frontal collision can be either head-on or angled between two vehicles, or when a vehicle crashes into a stationary object, such as a concrete wall.

■ How the Front Airbags Work

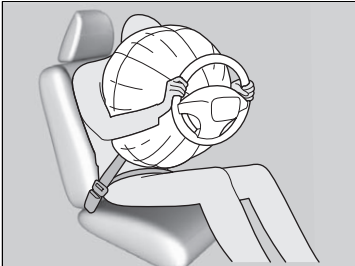

While your seat belt restrains your torso, the front airbag provides supplemental protection for your head and chest.

The front airbags deflate immediately so that they won't interfere with the driver's visibility or the ability to steer or operate other controls.

The total time for inflation and deflation is so fast that most occupants are not aware that the airbags deployed until they see them lying in front of them.

■ When front airbags should not deploy

Minor frontal crashes: Front airbags were designed to supplement seat belts and help to save lives, not to prevent minor scrapes, or even broken bones that might occur during a less than moderate-to-severe frontal crash.

Side impacts: Front airbags can provide protection when a sudden deceleration causes a driver or front passenger to move towards the front of the vehicle. Side airbags and side curtain airbags have been specifically designed to help to reduce the severity of injuries that can occur during a moderate-to-severe side impact which can cause the driver or passenger to move towards the side of the vehicle.

Rear impacts: Head restraints and seat belts are your best protection during a rear impact. Front airbags cannot provide any significant protection and are not designed to deploy in such collisions.

Rollovers: Seat belts, side airbags* and side curtain airbags* offer the best protection in a rollover. Because front airbags could provide little if any protection, they are not designed to deploy during a rollover.

■ When front airbags deploy with little or no visible damage

Because the airbag system senses sudden deceleration, a strong impact to the vehicle framework or suspension might cause one or more of the airbags to deploy. Examples include running into a curb, the edge of a hole, or other low fixed object that causes a sudden deceleration in the vehicle chassis. Since the impact is underneath the vehicle, damage may not be readily apparent.

■ When front airbags may not deploy, even though exterior damage appears severe

Since crushable body parts absorb crash energy during an impact, the amount of visible damage does not always indicate proper airbag operation. In fact, some collisions can result in severe damage but no airbag deployment because the airbags would not have been needed or would not have provided protection even if they had deployed.

Passenger Front Airbag Off System*

If it is unavoidable to install a rear-facing child restraint system in the front passenger seat, you must manually deactivate the passenger front airbag system, using the ignition key.

Passenger front airbag ON/OFF switch



When the passenger front airbag **ON/OFF** switch is in:

OFF: The passenger front airbag is deactivated. The passenger front airbag does not inflate during a frontal crash that inflates driver's front airbag.

The passenger front airbag off indicator stays on as a reminder.

ON: The passenger front airbag is activated. The passenger front airbag on indicator is comes on and remain on for about 60 seconds.

To deactivate the passenger front airbag system

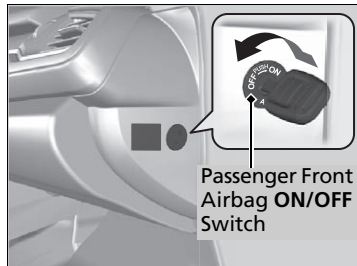

1. Set the parking brake, and turn the ignition switch to **LOCK** [0]*1. Remove the key.
2. Open the front passenger's door.
3. Insert the ignition key to the passenger front airbag **ON/OFF** switch.
 - ▶ The switch is located at the side panel of the front passenger side instrument panel.
4. Turn the key to **OFF**, and remove it from the switch.

*1: Models with the keyless access system have an **ENGINE START/STOP** button instead of an ignition switch.

Passenger Front Airbag Off System*

⚠ WARNING

The passenger front airbag system must be turned off, if it is not avoidable to put a rear-facing child restraint system in the front passenger seat.

If the front passenger airbag inflates, it can hit the rear-facing child restraint system with enough force to kill or cause a very serious injury to the infant.

⚠ WARNING

Make sure to turn on the passenger front airbag system when a rear-facing child restraint system is not used on the front passenger seat.

Leaving the passenger front airbag system deactivated can result in serious injury or death in a crash.

* Not available on all models

■ Passenger front airbag off indicator

When the passenger front airbag system is activated, the indicator goes off after a few seconds when you turn the ignition switch to ON *1.

When the passenger front airbag system is deactivated, the indicator stays on, or goes off momentarily and comes back on.

■ Passenger front airbag off system label

The label is located at the side panel of the front passenger side instrument panel.

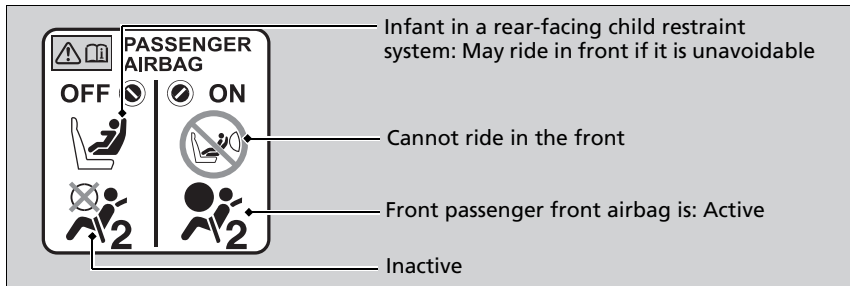

▶▶ Passenger Front Airbag Off System *

NOTICE

- Use your vehicle's ignition key to turn the passenger front airbag **ON/OFF** switch. If you use a different key, the switch can be damaged, or the passenger front airbag system may not work properly.
- Do not close the door or apply excessive load on the ignition key while the key is in the passenger front airbag **ON/OFF** switch. The switch or the key can be damaged.

We strongly recommend that you do not install a rear-facing child restraint system in the front passenger seat.

Protecting Infants P. 69

It is your responsibility to change the setting of the passenger front airbag system to **OFF** when you put a rear-facing child restraint system on the front passenger seat.

When a rear-facing child restraint system is not in use in the front passenger seat, turn the system back on.

*1: Models with the keyless access system have an **ENGINE START/STOP** button instead of an ignition switch.

* Not available on all models

Side Airbags*

The side airbags help to protect the upper torso of the driver or a front passenger during a moderate-to-severe side impact.

Housing Locations

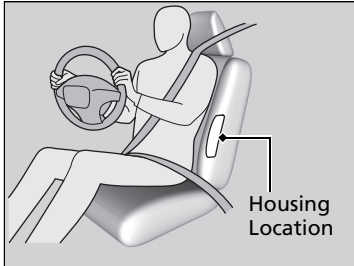

The side airbags are housed in the outside edge of the driver's and passenger's seat-backs.

Both are marked **SIDE AIRBAG**.

Side Airbags*

Do not let the front passenger lean sideways with their head in the deployment path of the side airbag. An inflating side airbag can strike with strong force and seriously injure the passenger.

Do not attach accessories on or near the side airbags. They can interfere with the proper operation of the airbags, or hurt someone if an airbag inflates.

* Not available on all models

■ Operation

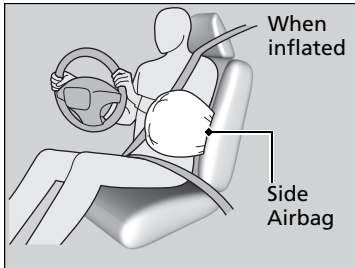

When the sensors detect a moderate-to-severe side impact, the control unit signals the side airbag on the impact side to immediately inflate.

■ When a side airbag deploys with little or no visible damage

Because the airbag system senses sudden acceleration, a strong impact to the side of the vehicle's framework can cause a side airbag to deploy. In such cases, there may be little or no damage, but the side impact sensors detected a severe enough impact to deploy the airbag.

■ When a side airbag may not deploy, even though visible damage appears severe

It is possible for a side airbag to not deploy during an impact that results in apparently severe damage. This can occur when the point of impact was towards the far front or rear of the vehicle, or when the vehicle's crushable body parts absorbed most of the crash energy. In either case, the side airbag would not have been needed nor provided protection even if it had deployed.

⊗ Side Airbags*

Do not cover or replace the front seat-back covers without consulting a dealer. Improperly replacing or covering front seat-back covers can prevent your side airbags from properly deploying during a side impact.

Side Curtain Airbags*

The side curtain airbags help to protect the heads of the driver and any passengers during a moderate-to-severe side impact.

Housing Locations

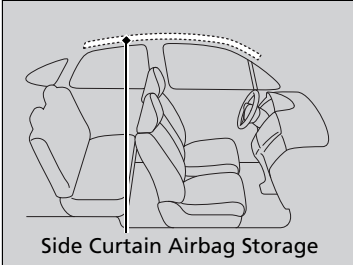

The side curtain airbags are located in the ceiling above the side windows on both sides of the vehicle.

Side Curtain Airbags*

The side curtain airbags are most effective when an occupant is wearing their seat belt properly and sitting upright, well back in their seat.

Do not attach any objects to the side windows or roof pillars as they can interfere with the proper operation of the side curtain airbags.

Do not put a coat hanger or hard objects on a coat hook. This could result in injuries if your side curtain airbag inflates.

■ Operation

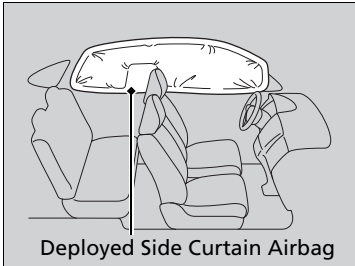

The side curtain airbag is designed to deploy in a moderate-to-severe side impact.

■ When side curtain airbags deploy in a frontal collision

One or both side curtain airbags may also inflate in a moderate-to-severe angled frontal collision.

Airbag System Indicators

If a problem occurs in the airbag system, the SRS indicator will come on and a message appears on the driver information interface*.

Supplemental Restraint System (SRS) Indicator

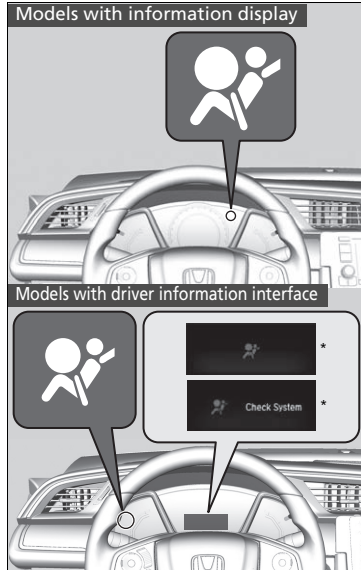

■ When the ignition switch is turned to ON *1

The indicator comes on for a few seconds, then goes off. This tells you the system is working properly.

If the indicator comes on at any other time, or does not come on at all, have the system checked by a dealer as soon as possible. If you don't, your airbags and seat belt tensioners may not work properly when they are needed.

*1: Models with the keyless access system have an **ENGINE START/STOP** button instead of an ignition switch.

* Not available on all models

Supplemental Restraint System (SRS) Indicator

WARNING

Ignoring the SRS indicator can result in serious injury or death if the airbag systems or tensioners do not work properly.

Have your vehicle checked by a dealer as soon as possible if the SRS indicator alerts you to a possible problem.

Models with passenger front airbag off system

WARNING

Remove the rear-facing child restraint system immediately from the front passenger seat if the SRS indicator comes on. Even if the passenger front airbag has been deactivated, do not ignore the SRS indicator.

The SRS system may have a fault which could cause the passenger front airbag to be activated, causing serious injury or death.

■ Passenger Front Airbag Off Indicator*

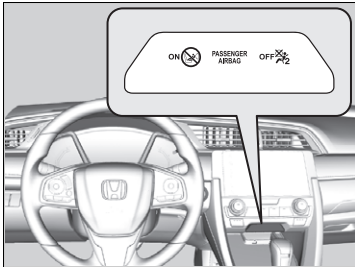

■ When the passenger airbag off indicator comes on

The indicator stays on while the passenger's front airbag system is deactivated.

When a rear-facing child restraint system is not in use in the front passenger seat, manually turn the system back on. The indicator should go off.

Airbag Care

You do not need to, and should not, perform any maintenance on or replace any airbag system components yourself. However, you should have your vehicle inspected by a dealer in the following situations:

■ When the airbags have deployed

If an airbag has inflated, the control unit and other related parts must be replaced. Similarly, once an automatic seat belt tensioner has been activated, it must be replaced.

■ When the vehicle has been in a moderate-to-severe collision

Even if the airbags did not inflate, have your dealer inspect the following: front seat belt tensioners and each seat belt that was worn during the crash.

⚠ Airbag Care

The removal of airbag components from the vehicle is prohibited.

In case of malfunction, or shutdown, or after the airbag inflation/seat belt tensioner operation, ask a qualified personnel for handling.

We recommend against the use of salvaged airbag system components, including the airbag, tensioners, sensors, and control unit.

Protecting Child Passengers

Each year, many children are injured or killed in vehicle crashes because they are either unrestrained or not properly restrained. In fact, vehicle crashes are the number one cause of death of children aged 12 and under.

To reduce the number of child deaths and injuries, infants and children should be properly restrained when they ride in a vehicle.

Protecting Child Passengers

⚠ WARNING

Children who are unrestrained or improperly restrained can be seriously injured or killed in a crash.

Any child too small for a seat belt should be properly restrained in an approved child restraint system. A larger child should be properly restrained with a seat belt, using a booster seat if necessary.

In many countries, the law requires all children aged 12 and under, and whose height are shorter than 150 cm be properly restrained in a rear seat.

In many countries, it is required to use an officially approved and suitable child restraint system for transporting a child on any passenger seat. Check your local legal requirement.

European models

Child restraint systems must meet UN Regulation No. 44 or No. 129, or the regulations of the subject countries.

➔ **Selecting a Child Restraint System** P. 72

Except European models

We recommend that child restraint systems meet UN Regulation No. 44 or No. 129*, or the regulations of the subject countries.

➔ **Selecting a Child Restraint System** P. 72

Children should sit properly restrained in a rear seat. This is because:

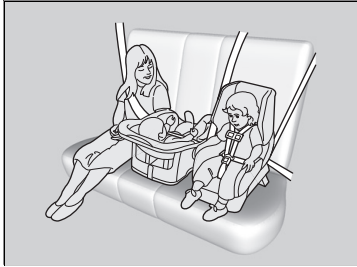

- An inflating front or side airbag* can injure or kill a child sitting in the front seat.
- A child in the front seat is more likely to interfere with the driver's ability to safely control the vehicle.
- Statistics show that children of all sizes and ages are safer when they are properly restrained in a rear seat.

- Any child who is too small to wear a seat belt must be properly restrained in an approved child restraint system that is properly secured to the vehicle using the seat belt or the child restraint anchorage system.
- Never hold a child on your lap because it is impossible to protect them in the event of a collision.
- Never put a seat belt over yourself and a child. During a crash, the belt would likely press deep into the child and cause serious or fatal injuries.
- Never let two children use the same seat belt. Both children could be very seriously injured in a crash.

* Not available on all models

Continued

▶▶ Protecting Child Passengers

Models with lockable retractor

⚠ WARNING

Allowing a child to play with a seat belt or wrap one around their neck can result in serious injury or death.

Instruct children not to play with any seat belts and make sure any unused seat belts a child can reach is buckled, fully retracted, and locked.

Front Passenger's Sun Visor

⚠ WARNING



NEVER use a rearward facing child restraint on a seat protected by an **ACTIVE AIRBAG** in front of it, **DEATH** or **SERIOUS INJURY** to the **CHILD** can occur.

- Do not allow children to operate the doors, windows or seat adjustments.
- Do not leave children in the vehicle unattended, especially in hot weather when the inside of the vehicle can get hot enough to kill them. They could also activate vehicle controls causing it to move unexpectedly.

▶▶ Protecting Child Passengers

WARNING: Use the power window lock button to prevent children from opening the windows. Using this feature will prevent children from playing with the windows, which could expose them to hazards or distract the driver.

▶ **Opening/Closing the Power Windows** P. 192

WARNING: Always take the ignition key with you whenever you leave the vehicle alone (with other occupants).

Models with lockable retractor

To deactivate a lockable retractor, release the buckle and allow the seat belt to wind up all the way.

To remind you of the passenger's front airbag hazards and child safety, your vehicle has the warning label on the passenger's side sun visor. Please read and follow the instructions on this label.

▶ **Safety Labels** P. 91

Safety of Infants and Small Children

Protecting Infants

An infant must be properly restrained in a rear-facing, reclining child restraint system until the infant reaches the seat maker's weight or height limit for the seat, and the infant is at least one year old.

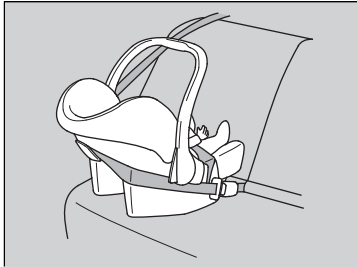

Positioning a rear-facing child restraint system

Child restraint system must be placed and secured in a rear seating position.

Protecting Infants

⚠ WARNING

Placing a rear-facing child restraint system in the front seat can result in serious injury or death if the passenger's front airbag inflates.

Always place a rear-facing child restraint system in the back seat, not the front.

As required by UN Regulation No. 94:

⚠ WARNING



NEVER use a rearward facing child restraint on a seat protected by an ACTIVE AIRBAG in front of it, DEATH or SERIOUS INJURY to the CHILD can occur.

When properly installed, a rear-facing child restraint system may prevent the driver or a front passenger from moving their seat all the way back, or from locking their seat-back in the desired position.

▶▶ Protecting Infants

If the passenger's front airbag inflates, it can hit the rear-facing child restraint system with great force, which can dislodge or strike the system, and seriously injure the child.

Rear-facing child restraint systems should never be installed in a front facing position.

Always refer to the child restraint system manufacturer's instructions before installation.

If it is absolutely unavoidable to install a rear-facing child restraint system in the front passenger seat, manually turn off the passenger front airbag system.

▶▶ **Passenger Front Airbag Off System** * P. 57

Protecting Smaller Children

If a child is at least one year old and has exceeded the weight and height limitations of a rear-facing child restraint system, the child should be properly restrained in a firmly secured front facing child restraint system until they exceed the weight and height limitations for the front facing child restraint system.

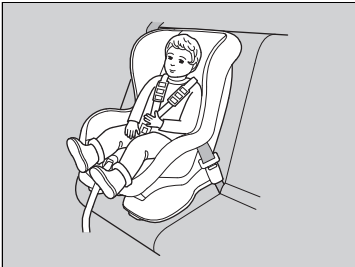

Front facing child restraint system placement

We strongly recommend placing a front facing child restraint system in a rear seating position.

Placing a front facing child restraint system in the front seat can be hazardous. A rear seat is the safest place for a child.

Protecting Smaller Children

⚠ WARNING

Placing a front facing child restraint system in the front seat can result in serious injury or death if the front airbag inflates.

If you must place a front facing child restraint system in front, move the vehicle seat as far back as possible, and properly restrain the child.

Educate yourself about the laws and regulations regarding child restraint system use where you are driving, and follow the child restraint system manufacturer's instructions.

Many experts recommend use of a rear-facing child restraint system for a child up to two years old, if the child's height and weight are appropriate for a rear-facing child restraint system.

■ Selecting a Child Restraint System

Some child restraint systems are lower anchorage compatible. Some have a rigid-type connector while others have a flexible-type connector. Both are equally easy to use. Some existing and previously owned child restraint systems can only be installed using the seat belt. Whichever type you choose, follow the child restraint system manufacturer's use and care instructions as well as the instructions in this manual. Proper installation is key to maximizing your child's safety.

The flexible type may not be available in your country.

In seating positions and vehicles not equipped with lower anchorages, install a child restraint system using the seat belt and a top tether for added security. This is because all child restraint systems must be secured with the seat belt when not using the lower anchorage system. In addition, the child restraint system manufacturer may advise that a seat belt be used to attach an ISO FIX* restraint system once a child reaches a specified weight. Please read the child restraint system owner's manual for proper installation instructions.

■ Important consideration when selecting a child restraint system

Make sure the child restraint system meets the following three requirements:

- The child restraint system is the correct type and size for the child.
- The child restraint system is the correct type for the seating position.
- Child restraint system is compliant with safety standard. We recommend the child restraint system with UN Regulation No. 44 or No. 129*, or the regulations of the subject countries. Look for the approval mark on the system and the manufacturer's statement of compliance on the box.

▶▶ Selecting a Child Restraint System

Installation of a lower anchorage-compatible child restraint system is simple.

Lower anchorage-compatible child restraint systems have been developed to simplify the installation process and reduce the likelihood of injuries caused by incorrect installation.

■ Child Restraint Systems Standards

If a child restraint system (whether an i-Size*/ISOFIX type or one that is fitted with a seat belt) meets the relevant UN Regulation, it will be affixed with an approval label as shown in the adjacent table. Before purchasing or using any child restraint system, make sure to check the approval label and ensure that it is compatible with your vehicle and the child, and that it complies with the relevant UN/ECE Regulation.

☒ Selecting a Child Restraint System

Example of UN Regulation No. 44 approval label

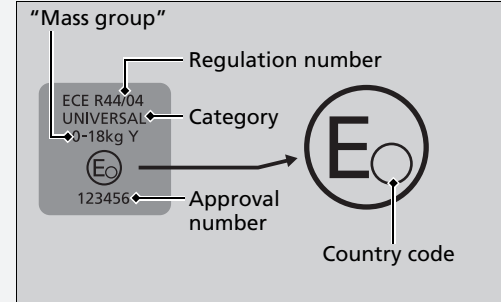

Example of UN Regulation No. 129 approval label*

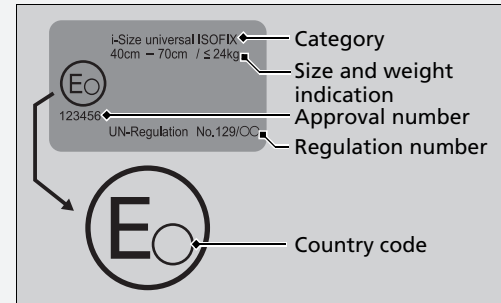

* Not available on all models

Continued

■ Lower Anchorage-Compatible Child Restraint Systems

The two outer rear seats in your vehicle are equipped with lower anchorages. However, not all of the various types of child restraint systems are suitable for use in your vehicle. Before you purchase or use any lower anchorage-compatible (i-Size*/ISOFIX) child restraint system, refer to the following tables to ensure that the restraint system is appropriate for the vehicle, the seating position, and the child's weight (mass group) and size.

☒ Lower Anchorage-Compatible Child Restraint Systems

Mass group is specified for some child restraint systems. Make sure to check the mass group as indicated in the manufacturer's instructions as well as on the package and labels of the child restraint system.

The particular child restraint systems listed in the table are genuine Honda products. They are available from your dealer.

For correct installation, refer to the instructions manual that came with the child restraint system.

European models

■ ISOFIX Child Restraint Systems

MASS Group	Size Class	Fixture	Vehicle ISOFIX positions				Recommended Child Restraint Systems*1
			Front passenger	Rear seat			
				L-Side	R-Side	Centre	
Carrycot	F	ISO/L1	—	X	X	—	
	G	ISO/L2	—	X	X	—	
group 0 up to 10 kg	E	ISO/R1	—	IL	IL	—	Honda Baby Safe ISOFIX
group 0+ up to 13 kg	E	ISO/R1	—	IL	IL	—	Honda Baby Safe ISOFIX
	D	ISO/R2	—	IL	IL	—	Honda Baby Safe ISOFIX
	C	ISO/R3	—	IL	IL	—	Honda Baby Safe ISOFIX
group I 9 to 18 kg	D	ISO/R2	—	IL	IL	—	
	C	ISO/R3	—	IL	IL	—	
	B	ISO/F2	—	IUF	IUF	—	Honda ISOFIX
	B1	ISO/F2X	—	IUF	IUF	—	Honda ISOFIX
	A	ISO/F3	—	IUF	IUF	—	Honda ISOFIX
group II 15 to 25 kg			—	X	X	—	
group III 22 to 36 kg			—	X	X	—	

☒ Lower Anchorage-Compatible Child Restraint Systems

When purchasing a child restraint systems, make sure to check the ISOFIX size class or the fixture to ensure that the seat is compatible with your vehicle.

ISOFIX Size Class	Fixture (CRF)	Description
G	ISO/L2	Right lateral-facing (carrycot) infant seat
F	ISO/L1	Left lateral-facing (carrycot) infant seat
E	ISO/R1	Rearward-facing infant seat
D	ISO/R2	Reduced-size rearward-facing child restraint systems
C	ISO/R3	Full-size rearward-facing child restraint systems
B1	ISO/F2X	Reduced-height forward-facing child restraint systems
B	ISO/F2	Reduced-height forward-facing child restraint systems
A	ISO/F3	Full-height, forward-facing child restraint systems

-
- *1: The named Child Restraint Systems (CRS) reflect Honda’s recommendations at the date of publication. You should speak to an authorised dealer for up-to-date information on our recommended CRSs. Other CRSs may also be suitable for use. Refer to the CRS manufacturer’s list of recommended vehicles for the CRS in question.
 - IUF: Suitable for forward-facing ISOFIX child restraints system of universal category approved for use in this mass group.
 - IL: Suitable for particular ISOFIX child restraint systems (CRS), including those listed in the corresponding box in the right column of the table. These ISOFIX CRS are those of the ‘specific vehicle’, ‘restricted’ or ‘semiuniversal’ categories.
Honda Baby Safe ISOFIX is able to equipped for rear-facing.
 - X: Seat position not suitable for children in this mass group.
-

■ i-Size Child Restraint Systems

	Seating position in the vehicle		
	Front seat	Rear outer seat	Rear centre seat
i-Size child restraint system	—	i-U	—

-
- i-U: Suitable for forward- and rearward-facing i-Size “universal” child restraint systems.
-

■ Child Restraint Systems to be Installed with a Lap/Shoulder Seat Belt

Not all of the various types of child restraint systems are suitable for use in your vehicle. Before you purchase or use a child restraint system, refer to the following table to ensure that the restraint system is appropriate for the vehicle, the seating position, and the child's weight (mass group) and size.

☒ Child Restraint Systems to be Installed with a Lap/Shoulder Seat Belt

Mass group is specified for some child restraint systems. Make sure to check the mass group as indicated in the manufacturer's instructions as well as on the package and labels of the child restraint system.

The particular child restraint systems listed in the table are genuine Honda products. They are available from your dealer.

For correct installation, refer to the instructions manual that came with the child restraint system.

Continued

European models

■ Child Restraint Systems installed with Seat Belt

MASS Group	Seating position					Recommended Child Restraint Systems*1
	Front passenger		Rear seat			
	Passenger front airbag ON/OFF switch position		L-Side	R-Side	Centre	
	ON	OFF				
group 0 up to 10 kg	X	U*2	U	U	U	Honda Baby Safe
group 0+ up to 13 kg	X	U*2	U	U	U	Honda Baby Safe
group I 9 to 18 kg	UF*2	U*2	U	U	U	Honda ISOFIX (Belted) Honda Eclipse
group II 15 to 25 kg	UF*2	U*2	U, L	U, L	U	Honda KID FIX XP SICT L; Honda KID FIX XP SICT with ISOFIX mounted
group III 22 to 36 kg	UF*2	U*2	U, L	U, L	U	Honda KID FIX XP SICT L; Honda KID FIX XP SICT with ISOFIX mounted

U: Suitable for “universal” category restraints approved for use in this mass group.

UF: Suitable for forward-facing “universal” category restraints approved for use in this mass group.

L: Suitable for particular child restraint systems (CRS) given in the table.

X: Seat position not suitable for children in this mass group.

*1: The named Child Restraint Systems (CRS) reflect Honda’s recommendations at the date of publication. You should speak to an authorised dealer for up-to-date information on our recommended CRSs. Other CRSs may also be suitable for use. Refer to the CRS manufacturer’s list of recommended vehicles for the CRS in question.

*2: Move the front seat to its slide rail rearmost and adjust the front seat-back angle to its most upright position.

■ Installing a Lower Anchorage-Compatible Child Restraint System

A lower anchorage-compatible child restraint system can be installed in either of the two rear outer seats. A child restraint system is attached to the lower anchorages with either the flexible or rigid type of connectors.

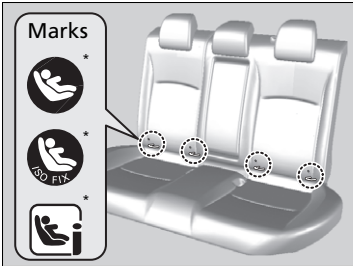

1. Locate the anchor marks affixed to the base of the seat cushion.

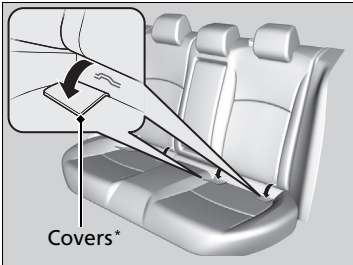

2. Pull out the anchor covers* under the marks to expose the lower anchorages.

▣ Installing a Lower Anchorage-Compatible Child Restraint System

Some child restraint systems come with optional guide-cups, which avoid possible damage to the seat surface. Follow the manufacturer's instructions when using the guide-cups, and attach them to the lower anchorages as shown in the image.

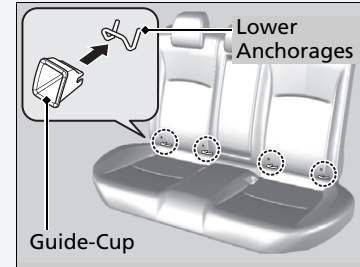

* Not available on all models

Continued

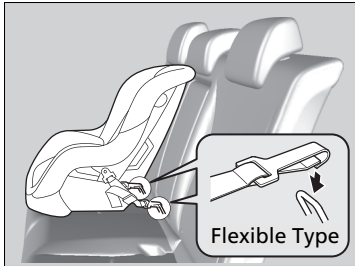
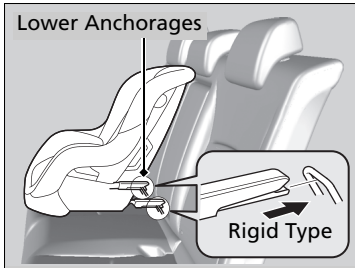

3. Place the child restraint system on the vehicle seat, then attach the child restraint system to the lower anchorages according to the instructions that came with the child restraint system.
 - ▶ When installing the child restraint system, make sure that the lower anchorages are not obstructed by the seat belt or any other object.

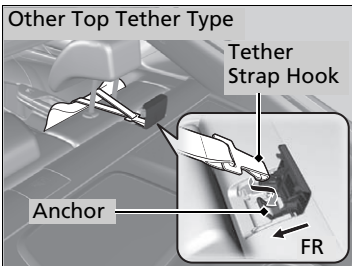
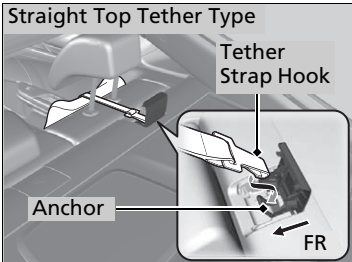
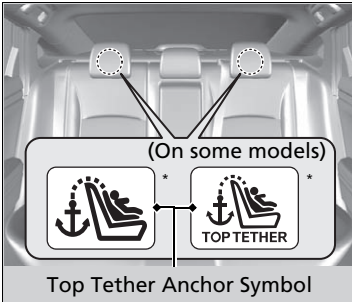

Child restraint system with tether strap

4. Open the tether anchorage cover behind the head restraint.

5. Raise the head restraint to its highest position, then route the tether strap through the head restraint legs, and secure the tether strap hook to the anchorage. Make sure the strap is not twisted.
6. Tighten the tether strap as instructed by the child restraint system manufacturer.

7. Make sure the child restraint system is firmly secured by rocking it forward and back and side to side; little movement should be felt.
8. Make sure any unused seat belt that a child can reach is buckled, the lockable retractor is activated, and the belt is fully retracted and locked.

►► Installing a Lower Anchorage-Compatible Child Restraint System

WARNING: Never use a hook that does not come with a Top Tether anchor symbol when securing an installed child restraint system.

For your child's safety, when using a child restraint system installed using the lower anchorage system, make sure that the child restraint system is properly secured to the vehicle. A child restraint system that is not properly secured will not adequately protect a child in a crash and may cause injury to the child or other vehicle occupants.

The flexible type may not be available in your country.

* Not available on all models

Continued

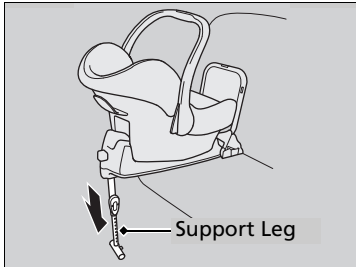

Child restraint system with support leg

4. Stretch the support leg until it touches the floor as instructed by the child restraint system manufacturer.

Installing a Child Restraint System with a Lap/Shoulder Seat Belt



1. Place the child restraint system on the vehicle seat.
2. Route the seat belt through the child restraint system according to the child restraint system manufacturer's instructions, and insert the latch plate into the buckle.

► Insert the latch plate fully until it clicks.

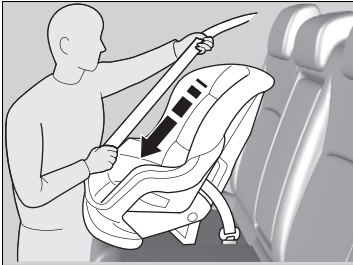

Models with lockable retractor

3. Slowly pull the shoulder part of the belt all the way out until it stops. This activates the lockable retractor.
4. Let the seat belt retract a few inches and check that the retractor has switched modes by pulling on the webbing. It should not pull out again until it is reset by removing the latch plate from the buckle.
 - If you are able to pull the shoulder belt out, the lockable retractor is not activated. Slowly pull the seat belt all the way out, and repeat steps 2 – 4.

Installing a Child Restraint System with a Lap/Shoulder Seat Belt

To check if the lap/shoulder belt is equipped with the lockable retractor, pull the shoulder part of the lap/shoulder belt all the way out, let the belt retract slowly, then pull the belt again gently. If the belt is locked, the belt is equipped with the lockable retractor.

Models with lockable retractor

The seat belt with a lockable retractor has a label as shown in the image.



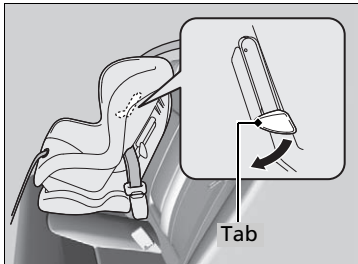

5. Grab the shoulder part of the seat belt near the buckle, and pull up to remove any slack from the lap part of the belt.
 - ▶ When doing this, place your weight on the child restraint system and push it into the vehicle seat.

Models without lockable retractor

3. Push down the tab. Route the shoulder part of the belt into the slit at the side of the restraint.
4. Grab the shoulder part of the belt near the buckle, and pull up to remove any slack from the lap part of the belt.
 - ▶ When doing this, place your weight on the child restraint system and push it into the vehicle seat.
5. Position the belt properly and push up the tab. Make sure the belt is not twisted.
 - ▶ When pushing up the tab, pull up the upper shoulder part of the belt to remove any slack from the belt.

▶▶ Installing a Child Restraint System with a Lap/Shoulder Seat Belt

A child restraint system that is not properly secured will not adequately protect a child in a crash and may cause injury to the child or other vehicle occupants.

Models with lockable retractor

After the child restraint system is installed properly, check if the lockable retractor is activated and the belt is fully retracted and locked. To deactivate a lockable retractor, release the buckle and allow the seat belt to wind up all the way.



All models

6. Make sure the child restraint system is firmly secured by rocking it forward and back and side to side; little movement should be felt.
7. Make sure any unused seat belt that a child can reach is buckled.

Models without lockable retractor

If your child restraint system does not come with a mechanism that secures the belt, install a locking clip on the seat belt.

After going through the step 1 and 2, pull up the shoulder part of the belt and make sure there is no slack in the lap portion.

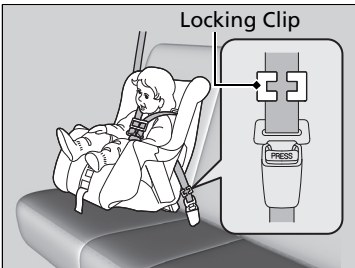

3. Tightly grasp the belt near the latch plate. Pinch both parts of the belt together so they do not slip through the latch plate. Unbuckle the seat belt.
4. Install the locking clip as shown in the image. Position the clip as close as possible to the latch plate.
5. Insert the latch plate into the buckle. Go to step 6 and 7.

■ Adding Security with a Tether

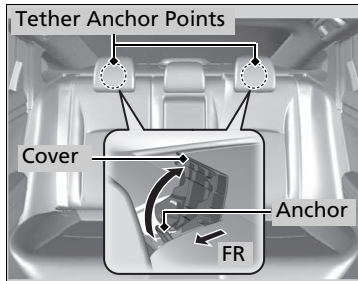

A tether anchorage point is provided behind each rear outer seating position. A child restraint system that is installed with a seat belt and comes with a tether can use the tether for additional security.

1. Locate the appropriate tether anchorage point and lift the cover.
2. Raise the head restraint to its highest position, then route the tether strap through the head restraint legs, and secure the tether strap hook to the anchorage. Make sure the strap is not twisted.
3. Secure the tether strap hook onto the anchorage.
4. Tighten the tether strap as instructed by the child restraint system manufacturer.

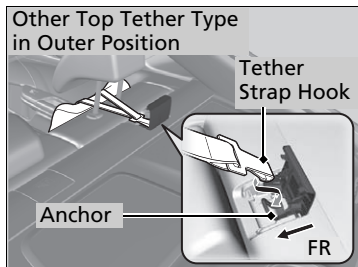
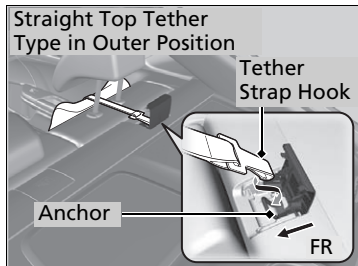

▣ Adding Security with a Tether

WARNING: Child restraint anchorages are designed to withstand only those loads imposed by correctly fitted child restraints. Under no circumstances are they to be used for adult seat belts, harnesses or for attaching other items or equipment to the vehicle.

Always use a tether for forward facing child seats when using the seat belt or lower anchors.

Safety of Larger Children

■ Protecting Larger Children

The following pages give instructions on how to check proper seat belt fit, what kind of booster seat to use if one is needed, and important precautions for a child who must sit in front.

■ Checking Seat Belt Fit

When a child is too big for a child restraint system, secure the child in a rear seat using the lap/shoulder seat belt. Have the child sit upright and all the way back, then answer the following questions.

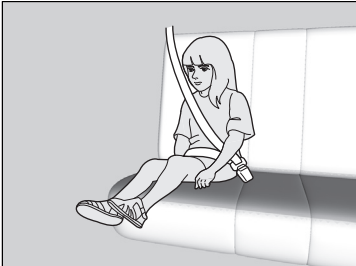

■ Checklist

- Do the child's knees bend comfortably over the edge of the seat?
- Does the shoulder belt cross between the child's neck and arm?
- Is the lap part of the seat belt as low as possible, touching the child's thighs?
- Will the child be able to stay seated like this for the whole trip?

If you answer yes to all these questions, the child is ready to wear the lap/shoulder seat belt correctly. If you answer no to any question, the child needs to ride on a booster seat until the seat belt fits properly without a booster seat.

▶▶ Safety of Larger Children

⚠ WARNING

Allowing a child aged 12 or under to sit in front can result in injury or death if the passenger's front airbag inflates.

If a larger child must ride in front, move the vehicle seat as far to the rear as possible, have the child sit up properly and wear the seat belt properly, using a booster seat if needed.

Booster Seats



If a lap/shoulder seat belt cannot be used properly, position the child in a booster seat in the rear seat. For the child's safety, check that the child meets the booster seat manufacturer's recommendations.

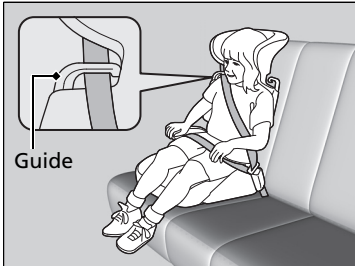

A back-rest is available for a specific booster seat. Install the back-rest to the booster seat and adjust it to the vehicle seat according to the booster seat manufacturer's instructions. Make sure the seat belt is properly routed through the guide at the shoulder of the back-rest and the belt does not touch and cross the child's neck.

Booster Seats

When installing a booster seat, make sure to read the instructions that came with it, and install the seat accordingly. There are high- and low-type booster seats. Choose a booster seat that allows the child to wear the seat belt correctly.

We recommend a booster seat with a backrest as it is easier to adjust the shoulder belt.

■ Protecting Larger Children - Final Checks

Your vehicle has a rear seat where children can be properly restrained. If you ever have to carry a group of children, and a child must ride in front:

- Make sure you read and fully understand the instructions and safety information in this manual.
- Move the front passenger seat as far back as possible.
- Have the child sit upright and well back in the seat.
- Check that the seat belt is properly positioned so that the child is secure in the seat.

■ Monitoring child passengers

We strongly recommend that you keep an eye on child passengers. Even older, more mature children sometimes need to be reminded to fasten their seat belts and sit up properly.

Carbon Monoxide Gas

The engine exhaust from this vehicle contains carbon monoxide, a colourless, odourless, and highly toxic gas. As long as you properly maintain your vehicle, carbon monoxide gas will not get into the interior.

■ Have the exhaust system inspected for leaks whenever

- The exhaust system is making an unusual noise.
- The exhaust system may have been damaged.
- The vehicle is raised for an oil change.

When you operate a vehicle with the boot open, airflow can pull exhaust gas into the interior and create a hazardous condition. If you must drive with the boot open, open all the windows and set the climate control system as shown below.

1. Select the fresh air mode.
2. Select the  mode.
3. Set the fan speed to high.
4. Set the temperature control to a comfortable setting.

Adjust the climate control system in the same manner if you sit in your parked vehicle with the engine running.

Carbon Monoxide Gas

WARNING

Carbon monoxide gas is toxic.

Breathing it can cause unconsciousness and even kill you.

Avoid any enclosed areas or activities that expose you to carbon monoxide.

An enclosed area such as a garage can quickly fill up with carbon monoxide gas.

Do not run the engine with the garage door closed. Even when the garage door is open, drive out of the garage immediately after starting the engine.

Label Locations

These labels are in the locations shown. They warn you of potential hazards that can cause serious injury or death. Read these labels carefully.

If a label comes off or becomes hard to read, contact a dealer for a replacement.

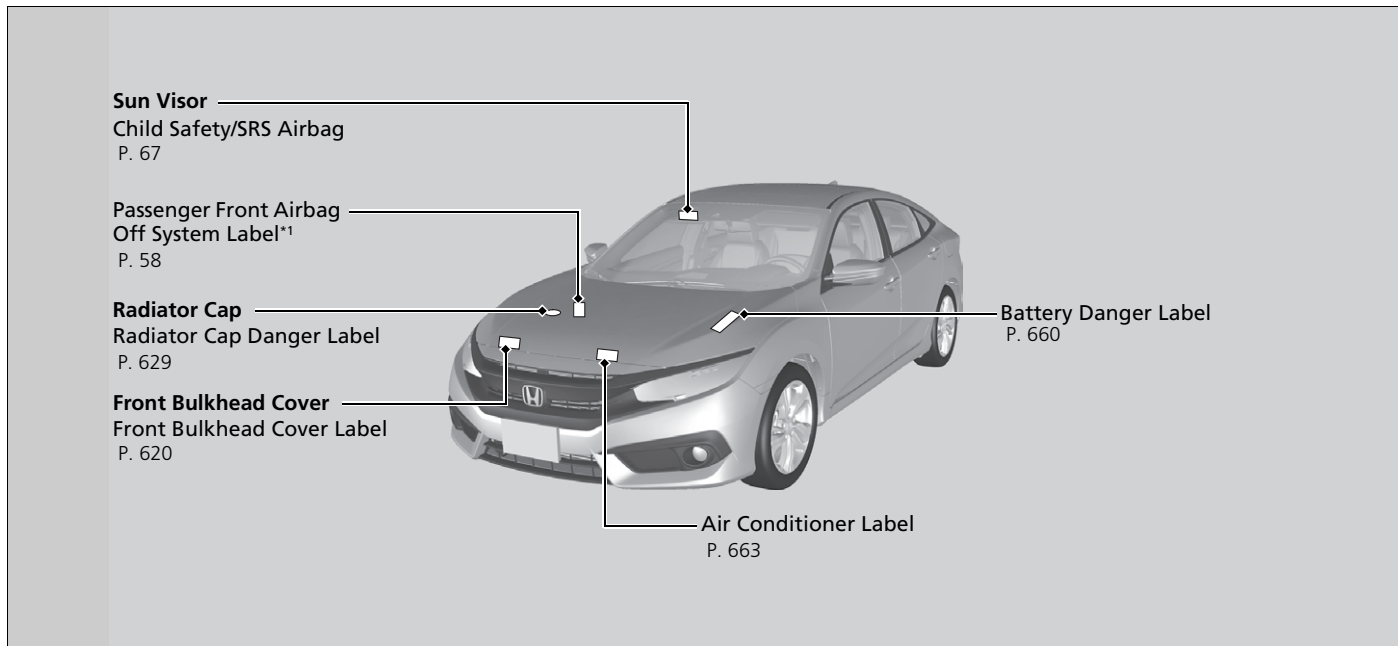

*1: Israeli, Turkish, and except Middle Eastern models

Instrument Panel

This chapter describes the buttons, indicators, and gauges that are used while driving.



Indicators

Information Display Warning and Information Messages*	125
Driver Information Interface Warning and Information Messages*	126

Gauges and Displays



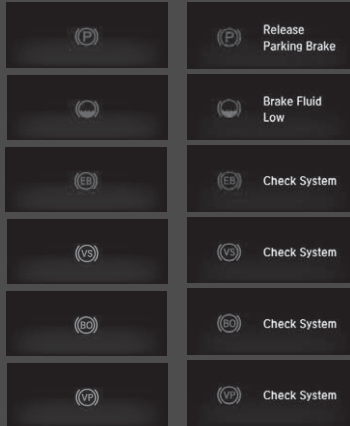



Gauges	151
Information Display*	152
Driver Information Interface*	155

Indicator	Name	On/Blinking	Explanation	Message*
 (Red)	Parking Brake and Brake System Indicator (Red)	<ul style="list-style-type: none"> Comes on for a few seconds when you turn the ignition switch to ON [II]*¹, then goes off if the parking brake has been released. Comes on when the parking brake is applied and goes off when it is released. Comes on when the brake fluid level is low. Comes on if there is a problem with the brake system. The beeper sounds and the indicator comes on if you drive with the parking brake not fully released. Comes on for about 15 seconds when you pull the electric parking brake switch while the ignition switch is in LOCK [0]*¹. Stays on for about 15 seconds when you turn the ignition switch to LOCK [0]*¹ while the electric parking brake is set. 	<ul style="list-style-type: none"> Comes on while driving - Make sure the parking brake is released. Check the brake fluid level. <ul style="list-style-type: none"> ➤ What to do when the indicator comes on P. 702 Comes on along with the ABS indicator - Have your vehicle checked by a dealer. <ul style="list-style-type: none"> ➤ If the Brake System Indicator (Red) Comes On or Blinks P. 704 Blinks and the brake system indicator (amber) comes on at the same time - There is a problem with the electric parking brake system. The parking brake may not be set. Avoid using the parking brake and have your vehicle checked by a dealer immediately. <ul style="list-style-type: none"> ➤ If the Brake System Indicator (Red) comes on or blinks at the same time when the Brake System Indicator (Amber) comes on P. 705 	<div style="display: flex; justify-content: space-around;"> <div style="text-align: center;">*2</div> <div style="text-align: center;">*3</div> </div> 

*1: Models with the keyless access system have an **ENGINE START/STOP** button instead of an ignition switch.

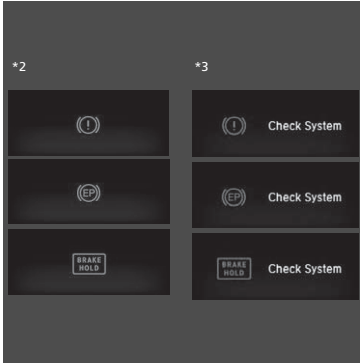
*2: Israeli, Turkish, and except Middle Eastern models



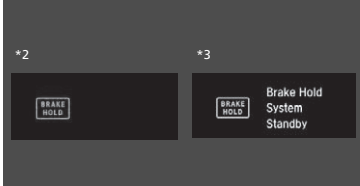









*3: Middle Eastern except Israeli and Turkish models

Indicator	Name	On/Blinking	Explanation	Message*
 (Amber)	Parking Brake and Brake System Indicator (Amber)	<ul style="list-style-type: none"> Comes on for a few seconds when you turn the ignition switch to ON *1, then goes off. Comes on if there is a problem with a system related to braking other than the conventional brake system. Comes on if there is a problem with the electric parking brake system or the automatic brake hold system. 	<ul style="list-style-type: none"> Stays on constantly - Have your vehicle checked by a dealer. Comes on while driving - Avoid using the parking brake and have your vehicle checked by a dealer immediately. 	 <p>*2</p> <p>*3</p>
	Automatic Brake Hold System Indicator	<ul style="list-style-type: none"> Comes on for a few seconds when you turn the ignition switch to ON *1, then goes off. Comes on when the automatic brake hold system is on. 	 Automatic Brake Hold P. 563	 <p>*2</p> <p>*3</p>

*1: Models with the keyless access system have an **ENGINE START/STOP** button instead of an ignition switch.

*2: Israeli, Turkish, and except Middle Eastern models









*3: Middle Eastern except Israeli and Turkish models

Indicator	Name	On/Blinking	Explanation	Message *
	Automatic Brake Hold Indicator	<ul style="list-style-type: none"> Comes on for a few seconds when you turn the ignition switch to ON ^{*1}, then goes off. Comes on when the automatic brake hold is activated. 	<ul style="list-style-type: none">  Automatic Brake Hold P. 563 	
 (Red)	Low Oil Pressure Indicator (Red)	<ul style="list-style-type: none"> Comes on when you turn the ignition switch to ON ^{*1}, and goes off when the engine starts. Comes on when the engine oil pressure is low. 	<ul style="list-style-type: none"> Comes on while driving - Immediately stop in a safe place.  If the Low Oil Pressure Indicator Comes On P. 702 	
 (Amber)	Low Oil Level Indicator* (Amber)	<ul style="list-style-type: none"> Comes on when the engine oil level is low while the engine is running. 	<ul style="list-style-type: none"> Comes on with amber while driving - Immediately stop in a safe place.  If the Low Oil Pressure Indicator Comes On P. 702 	
		<ul style="list-style-type: none"> Blinks when the engine is running, there is a system problem in the engine oil level sensor. 	<ul style="list-style-type: none"> Have your vehicle checked by a dealer. 	

*1: Models with the keyless access system have an **ENGINE START/STOP** button instead of an ignition switch.

*2: Israeli, Turkish, and except Middle Eastern models









*3: Middle Eastern except Israeli and Turkish models

Indicator	Name	On/Blinking	Explanation	Message*
	<p>Malfunction Indicator Lamp</p>	<ul style="list-style-type: none"> • Comes on when you turn the ignition switch to ON ^{*1}, and goes off either when the engine starts, or after several seconds if the engine did not start. • Comes on if there is a problem with the emissions control systems. • Blinks when a misfire in the engine's cylinders is detected. 	<ul style="list-style-type: none"> • Comes on while driving - Have your vehicle checked by a dealer. • Shows the self-testing condition of the diagnostics of the emission control system. • Blinks while driving - Stop in a safe place where there are no flammable objects. Stop the engine for 10 minutes or more, and wait for it to cool down. Then, take the vehicle to a dealer. <ul style="list-style-type: none"> ► If the Malfunction Indicator Lamp Comes On or Blinks P. 703 	<div style="display: flex; justify-content: space-around;"> <div data-bbox="1139 389 1310 482"> <p>*2</p>  </div> <div data-bbox="1319 389 1490 482"> <p>*3</p>  </div> </div>
	<p>Charging System Indicator</p>	<ul style="list-style-type: none"> • Comes on when you turn the ignition switch to ON ^{*1}, and goes off when the engine starts. • Comes on when the battery is not charging. 	<ul style="list-style-type: none"> • Comes on while driving - Turn off the climate control system and rear demister in order to reduce electricity consumption. <ul style="list-style-type: none"> ► If the Charging System Indicator Comes On P. 702 	<div style="display: flex; justify-content: space-around;"> <div data-bbox="1139 717 1310 810"> <p>*2</p>  </div> <div data-bbox="1319 717 1490 810"> <p>*3</p>  </div> </div>

*1: Models with the keyless access system have an **ENGINE START/STOP** button instead of an ignition switch.

*2: Israeli, Turkish, and except Middle Eastern models











*3: Middle Eastern except Israeli and Turkish models

Indicator	Name	On/Blinking	Explanation	Message *
	Shift Lever Position Indicator*	<ul style="list-style-type: none"> Indicates the current shift lever position. 	<p>➤ Shifting P. 468, 475</p>	—
	Transmission System Indicator*	<ul style="list-style-type: none"> Comes on for a few seconds when you turn the ignition switch to ON ^{*1}, then goes off. Blinks if the transmission system has a problem. 	<ul style="list-style-type: none"> Blinks while driving - Avoid sudden starts and acceleration and have your vehicle checked by a dealer immediately. 	<div style="display: flex; justify-content: space-around;"> <div style="text-align: center;"> <p>^{*2}</p>  <p>Check System</p> </div> <div style="text-align: center;"> <p>^{*3}</p>  <p>Check System. Stop Driving When Safe.</p> </div> </div>
	M (7-speed manual shift mode) Indicator/ Shift Indicator*	<ul style="list-style-type: none"> Comes on when the 7-speed manual shift mode is applied. Blinks if the transmission system has a problem. 	<p>➤ 7-Speed Manual Shift Mode P. 472</p>	—
	Shift Up Indicator*	<ul style="list-style-type: none"> Comes on briefly when you turn the ignition switch to ON ^{*1}, then goes off. Comes on when shifting up is recommended. 	<p>➤ Shift Up/Down Indicators* P. 476</p>	—

*1: Models with the keyless access system have an **ENGINE START/STOP** button instead of an ignition switch.

*2: Israeli, Turkish, and except Middle Eastern models





*3: Middle Eastern except Israeli and Turkish models

Indicator	Name	On/Blinking	Explanation	Message*
	Shift Down Indicator*	<ul style="list-style-type: none"> Comes on briefly when you turn the ignition switch to ON ^{*1}, then goes off. Comes on when shifting down is recommended. 	<ul style="list-style-type: none">  Shift Up/Down Indicators* P. 476 	—
	Seat Belt Reminder Indicator	<ul style="list-style-type: none"> Comes on and the beeper sounds* if you are not wearing a seat belt when you turn the ignition switch to ON ^{*1}. Blinks while driving if either you or the front passenger* has not fastened a seat belt. The beeper sounds* and the indicator blinks at regular intervals. <div data-bbox="440 706 724 754" style="background-color: #333; color: white; padding: 2px;"> Models with front passenger seat belt reminder </div> <ul style="list-style-type: none"> If the front passenger is not wearing a seat belt, the indicator comes on a few seconds later. 	<ul style="list-style-type: none"> The beeper stops and the indicator goes off when you and the front passenger* fasten their seat belts. Stays on after you or the front passenger* has fastened the seat belt - A detection error may have occurred in the sensor. Have your vehicle checked by a dealer. <ul style="list-style-type: none">  Seat Belt Reminder P. 43 	<div style="display: flex; justify-content: space-around;"> <div data-bbox="1139 552 1305 717"> <p>^{*2}</p>  </div> <div data-bbox="1315 552 1490 717"> <p>^{*3}</p>  <p>Fasten Seat Belt</p> </div> </div> <div style="display: flex; justify-content: space-around; margin-top: 10px;"> <div data-bbox="1139 650 1305 717">  </div> <div data-bbox="1315 650 1490 717">  <p>Fasten Passenger's Seat Belt</p> </div> </div>

* 1: Models with the keyless access system have an **ENGINE START/STOP** button instead of an ignition switch.

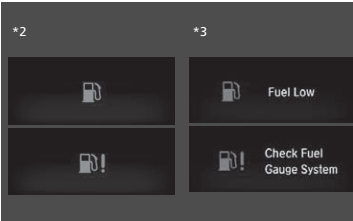
*2: Israeli, Turkish, and except Middle Eastern models

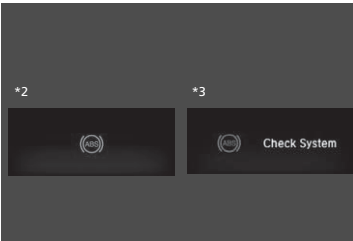

*3: Middle Eastern except Israeli and Turkish models

Indicator	Name	On/Blinking	Explanation	Message *
	Low Fuel Indicator	<ul style="list-style-type: none"> Comes on when the fuel reserve is running low (approximately 7.0 litres left). Blinks if there is a problem with the fuel gauge. 	<ul style="list-style-type: none"> Comes on - Refuel your vehicle as soon as possible. Blinks - Have your vehicle checked by a dealer. 	
	Anti-lock Brake System (ABS) Indicator	<ul style="list-style-type: none"> Comes on for a few seconds when you turn the ignition switch to ON ^{*1}, then goes off. If it comes on at any other time, there is a problem with the ABS. 	<ul style="list-style-type: none"> Stays on constantly - Have your vehicle checked by a dealer. With this indicator on, your vehicle still has normal braking ability but no anti-lock function. <p> Anti-lock Brake System (ABS) P. 566</p>	

*1: Models with the keyless access system have an **ENGINE START/STOP** button instead of an ignition switch.

*2: Israeli, Turkish, and except Middle Eastern models



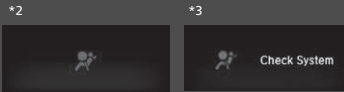

*3: Middle Eastern except Israeli and Turkish models

Indicator	Name	On/Blinking	Explanation	Message*
	Supplemental Restraint System Indicator	<ul style="list-style-type: none"> • Comes on for a few seconds when you turn the ignition switch to ON ^{*1}, then goes off. • Comes on if a problem with any of the following is detected: <ul style="list-style-type: none"> - Supplemental restraint system - Side airbag system* - Side curtain airbag system* - Seat belt tensioner 	<ul style="list-style-type: none"> • Stays on constantly or does not come on at all - Have your vehicle checked by a dealer. 	





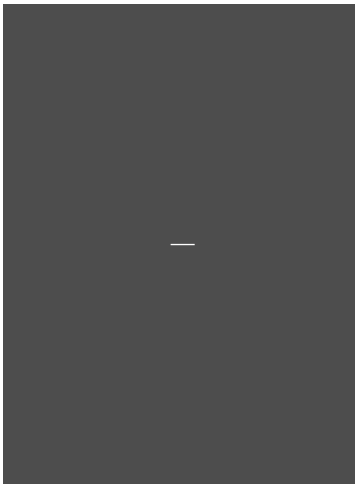

*1: Models with the keyless access system have an **ENGINE START/STOP** button instead of an ignition switch.

*2: Israeli, Turkish, and except Middle Eastern models

*3: Middle Eastern except Israeli and Turkish models

Indicator	Name	On/Blinking	Explanation	Message*
 ON  OFF	Passenger Front Airbag On/Off Indicators*	<ul style="list-style-type: none"> Both indicators come on for a few seconds when you turn the ignition switch to ON *¹, then goes off after a system check up. When the passenger front airbag is active: The on indicator comes back on and remains on for about 60 seconds. When the passenger front airbag is inactive: The off indicator comes back on and stays on. This is a reminder that the passenger front airbag is deactivated. 	 Passenger Front Airbag Off System* P. 57	





*1: Models with the keyless access system have an **ENGINE START/STOP** button instead of an ignition switch.

Indicator	Name	On/Blinking	Explanation	Message*
	Vehicle Stability Assist (VSA) System Indicator	<ul style="list-style-type: none"> • Comes on for a few seconds when you turn the ignition switch to ON *1, then goes off. • Blinks when VSA is active. • Comes on if there is a problem with the VSA system or hill start assist system. 	<ul style="list-style-type: none"> • Stays on constantly - Have your vehicle checked by a dealer.  Vehicle Stability Assist (VSA) System P. 550 	<div style="display: flex; justify-content: space-around;"> <div data-bbox="1137 244 1310 418"> <p>*2</p>  </div> <div data-bbox="1321 244 1492 418"> <p>*3</p>  Check System </div> </div>
		<ul style="list-style-type: none"> • Comes on if the VSA system is deactivated temporarily after the battery has been disconnected, then re-connected. 	<ul style="list-style-type: none"> • Drive a short distance at more than 20 km/h. The indicator should go off. If it does not, have your vehicle checked by a dealer. 	<div style="display: flex; justify-content: space-around;"> <div data-bbox="1137 496 1310 594"> <p>*2</p>  </div> <div data-bbox="1321 496 1492 594"> <p>*3</p>  Drive Carefully. Systems Initializing... </div> </div>

*1: Models with the keyless access system have an **ENGINE START/STOP** button instead of an ignition switch.

*2: Israeli, Turkish, and except Middle Eastern models

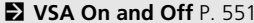

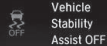





*3: Middle Eastern except Israeli and Turkish models

Indicator	Name	On/Blinking	Explanation	Message *
	Vehicle Stability Assist (VSA) OFF Indicator	<ul style="list-style-type: none"> Comes on for a few seconds when you turn the ignition switch to ON ^{*1}, then goes off. Comes on when you deactivate VSA. 		 OFF  Vehicle Stability Assist OFF
		<ul style="list-style-type: none"> Comes on if the VSA system is deactivated temporarily after the battery has been disconnected, then re-connected. 		<ul style="list-style-type: none"> Drive a short distance at more than 20 km/h. The indicator should go off. If it does not, have your vehicle checked by a dealer.

*1: Models with the keyless access system have an **ENGINE START/STOP** button instead of an ignition switch.

*2: Israeli, Turkish, and except Middle Eastern models



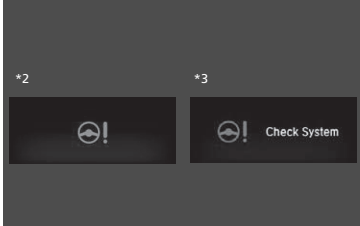

*3: Middle Eastern except Israeli and Turkish models

Indicator	Name	On/Blinking	Explanation	Message*
	Door and Boot Open Indicator*	<ul style="list-style-type: none"> Comes on for a few seconds when you turn the ignition switch to ON ^{*1}, then goes off. Comes on if any door or the boot is not completely closed. The beeper sounds and the indicator comes on if any door or the boot is opened while driving. 	<ul style="list-style-type: none"> Goes off when all doors and boot are closed. 	
	Transmission Temperature Indicator*	<ul style="list-style-type: none"> Comes on when the transmission fluid temperature is too high. 	<ul style="list-style-type: none"> Stop in a safe place and move the shift position to . 	
	Electric Power Steering (EPS) System Indicator	<ul style="list-style-type: none"> Comes on when you turn the ignition switch to ON ^{*1}, and goes off when the engine starts. Comes on if there is a problem with the EPS System. 	<ul style="list-style-type: none"> Stays on constantly or does not come on at all - Have your vehicle checked by a dealer. <ul style="list-style-type: none">  If the Electric Power Steering (EPS) System Indicator Comes On P. 706 	

*1: Models with the keyless access system have an **ENGINE START/STOP** button instead of an ignition switch.

*2: Israeli, Turkish, and except Middle Eastern models

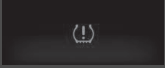

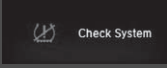

*3: Middle Eastern except Israeli and Turkish models

Indicator	Name	On/Blinking	Explanation	Message *
	Low Tyre Pressure/Deflation Warning System Indicator*	<ul style="list-style-type: none"> • Comes on for a few seconds when you turn the ignition switch to ON *1, then goes off. • May come on briefly if the ignition switch is turned to ON *1 and the vehicle is not moved within 45 seconds, to indicate the calibration process is not yet complete. • Comes on and stays on when: <ul style="list-style-type: none"> - One or more tyres' pressures are determined to be significantly low. - The system has not been calibrated. 	<ul style="list-style-type: none"> • Comes on while driving - Stop in a safe place, check tyre pressures, and inflate the tyre(s) if necessary. • Stays on after the tyres are inflated to the recommended pressures - The system needs to be calibrated. <ul style="list-style-type: none"> ▣ Deflation Warning System Calibration P. 556 	*2  *3 
		<ul style="list-style-type: none"> • Blinks for about one minute, and then stays on if there is a problem with the deflation warning system. 	<ul style="list-style-type: none"> • Blinks and remains on - Have your vehicle checked by a dealer. 	*2  *3 

*1:Models with the keyless access system have an **ENGINE START/STOP** button instead of an ignition switch.

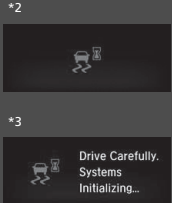
*2:Israeli, Turkish, and except Middle Eastern models

*3:Middle Eastern except Israeli and Turkish models

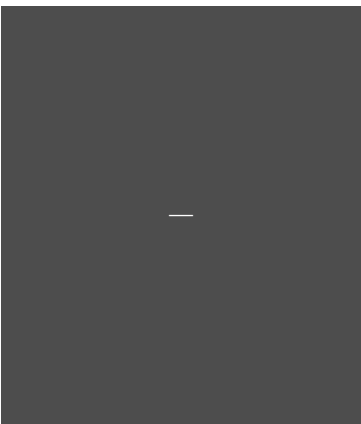



Indicator	Name	On/Blinking	Explanation	Message*
	<p>Low Tyre Pressure/Deflation Warning System Indicator*</p>	<ul style="list-style-type: none"> • Comes on if the deflation warning system is deactivated temporarily after the battery has been disconnected, then re-connected. 	<ul style="list-style-type: none"> • Drive a short distance at more than 20 km/h. The indicator should go off. If it does not, have your vehicle checked by a dealer. 	
	<p>System Message Indicator*</p>	<ul style="list-style-type: none"> • Comes on for a few seconds when you turn the ignition switch to ON *1, then goes off. • Comes on along with a beep when a problem is detected. A system message on the driver information interface appears at the same time. 	<ul style="list-style-type: none"> • While the indicator is on, press the  (display/information) button to see the message again. • Refer to the Indicators information in this chapter when a system message appears on the driver information interface. Respond to the message accordingly. • The driver information interface does not return to the normal screen unless the warning is cancelled, or the  button is pressed. 	

* 1: Models with the keyless access system have an **ENGINE START/STOP** button instead of an ignition switch.





* 2: Israeli, Turkish, and except Middle Eastern models

* 3: Middle Eastern except Israeli and Turkish models



* Not available on all models

Indicator	Name	On/Blinking	Explanation	Message*
	Turn Signal and Hazard Warning Indicators	<ul style="list-style-type: none"> • Blink when you operate the turn signal lever. • If you press the hazard warning button, both indicators and all turn signals blink at the same time. 	<ul style="list-style-type: none"> • Does not blink or blinks rapidly - A turn signal light bulb has blown. Change the bulb immediately. <ul style="list-style-type: none"> ➤ Replacing Light Bulbs P. 638, 640, 641 	—
		<p>Models with emergency stop signal</p> <ul style="list-style-type: none"> • Blink four times when the emergency stop signal is active. 	<ul style="list-style-type: none"> • Emergency Stop Signal P. 568 	
	High Beam Indicator	<ul style="list-style-type: none"> • Comes on when the high beam headlights are on. 	—	—
	Lights On Indicator	<ul style="list-style-type: none"> • Comes on whenever the light switch is on, or in AUTO* when the exterior lights are on. 	<ul style="list-style-type: none"> • If you remove the key from the ignition switch*1 while the lights are on, a chime sounds when the driver's door is opened. 	—
	Front Fog Light Indicator*	<ul style="list-style-type: none"> • Comes on when the front fog lights are on. 	—	—
	Rear Fog Light Indicator*	<ul style="list-style-type: none"> • Comes on when the rear fog light is on. 	—	—



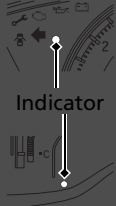

*1: Models with the keyless access system have an **ENGINE START/STOP** button instead of an ignition switch.

Indicator	Name	On/Blinking	Explanation	Message*
	Light Control Indicator*	<ul style="list-style-type: none"> Comes on if there is a problem with the light control system. 	<ul style="list-style-type: none"> Comes on while driving - Manually turn the lights on, and have your vehicle checked by a dealer. 	—
		<ul style="list-style-type: none"> Comes on if there is a problem with the headlights. 	<ul style="list-style-type: none"> Comes on while driving - The headlights may not be on. When conditions allow you to drive safely, have your vehicle checked by a dealer as soon as possible. 	—
	Auto High-Beam (High Beam Support System) Indicator*	<ul style="list-style-type: none"> Comes on for a few seconds when you turn the ignition switch to ON *1, then goes off. Comes on when all the operating conditions of the auto high-beam are met. 	<ul style="list-style-type: none">  Auto High-Beam (High Beam Support System)* P. 208 	—

*1: Models with the keyless access system have an **ENGINE START/STOP** button instead of an ignition switch.





Indicator	Name	On/Blinking	Explanation	Message*
 <p>Indicator</p>	<p>Immobilizer System Indicator</p>	<ul style="list-style-type: none"> Blinks if the immobilizer system cannot recognize the key information. 	<ul style="list-style-type: none"> Blinks - You cannot start the engine. Turn the ignition switch to LOCK 0*¹, pull the key out, and then insert the key and turn it to ON II*¹ again. Repeatedly blinks - The system may be malfunctioning. Have your vehicle checked by a dealer. Do not attempt to alter this system or add other devices to it. Electrical problems can occur. 	<p>—</p>
 <p>Indicator</p>	<p>Security System Alarm Indicator</p>	<ul style="list-style-type: none"> Blinks when the security system alarm has been set. 	<p> Security System Alarm P. 189</p>	<p>—</p>



*1:Models with the keyless access system have an **ENGINE START/STOP** button instead of an ignition switch.

Indicator	Name	On/Blinking	Explanation	Message*
	Keyless Access System Indicator*	<ul style="list-style-type: none"> Comes on for a few seconds when you change the power mode to ON, then goes off. Comes on as soon as a problem is detected in the keyless access system or keyless starting system. 	<ul style="list-style-type: none"> Have your vehicle checked by a dealer. 	—
	ECON Mode Indicator	<ul style="list-style-type: none"> Comes on when ECON mode is on. 	 ECON Button P. 483	<div style="display: flex; justify-content: space-around;"> <div style="text-align: center;"> <small>*1</small>  </div> <div style="text-align: center;"> <small>*2</small>  </div> </div>
120 km/h	Speed Alarm Indicator*	<ul style="list-style-type: none"> Comes on when your vehicle speed exceeds 120 km/h. 	<ul style="list-style-type: none"> If your vehicle speed exceeds 120 km/h, a reminder tone sounds once and the speed alarm indicator starts to blink. The indicator will stay blinking as long as you drive your vehicle faster than 120 km/h. 	—

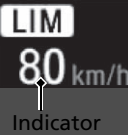

*1:Israeli, Turkish, and except Middle Eastern models

*2:Middle Eastern except Israeli and Turkish models







Indicator	Name	On/Blinking	Explanation	Message*
	CRUISE MAIN Indicator*	<ul style="list-style-type: none"> Comes on when you press the CRUISE button. 	<ul style="list-style-type: none"> ➤ Cruise Control* P. 484 	—
	CRUISE CONTROL Indicator*	<ul style="list-style-type: none"> Comes on when you have set a speed for cruise control. 	<ul style="list-style-type: none"> ➤ Cruise Control* P. 484 	—
	Cruise Main Indicator*	<ul style="list-style-type: none"> Comes on when you press the MAIN button. If a different indicator comes on, subsequently press the LIM button. 	<ul style="list-style-type: none"> ➤ Cruise Control* P. 487 	—
	Adjustable Speed Limiter Indicator*	<ul style="list-style-type: none"> Comes on when you press the MAIN button. If a different indicator comes on, subsequently press the LIM button. 	<ul style="list-style-type: none"> ➤ Adjustable Speed Limiter* P. 490 	—
	Cruise Control and Adjustable Speed Limiter Set Speed Indicator*	<ul style="list-style-type: none"> Comes on when you have set a speed for cruise control. Comes on when you have set a speed for adjustable speed limiter. 	<ul style="list-style-type: none"> ➤ Cruise Control* P. 488 ➤ Adjustable Speed Limiter* P. 491 	—

Indicator	Name	On/Blinking	Explanation	Message*
	Intelligent Speed Limiter Indicator*	<ul style="list-style-type: none"> Comes on when you press the MAIN button. If a different indicator comes on, subsequently press the LIM button. 	<ul style="list-style-type: none"> ➤ Intelligent Speed Limiter P. 494 	—
	Adaptive Cruise Control (ACC) and Intelligent Speed Limiter Set Speed Indicator*	<ul style="list-style-type: none"> Comes on when the intelligent speed limiter is set to the speed limit that the traffic sign recognition system detects. Comes on when you have set a speed for intelligent speed limiter. 	<ul style="list-style-type: none"> ➤ Adaptive Cruise Control (ACC) with Low Speed Follow (LSF)* P. 503 ➤ Intelligent Speed Limiter P. 494 	—

* Not available on all models

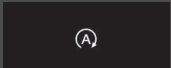



Indicator	Name	On/Blinking	Explanation	Message*
	Starter System Indicator*	<ul style="list-style-type: none"> Comes on when the starting system has a problem. 	<ul style="list-style-type: none"> As a temporary measure, press and hold the ENGINE START/STOP button for 15 seconds while depressing the brake pedal and manually start the engine. Have the vehicle checked by a dealer. 	—
	Rotate Wheel Indicator*	<ul style="list-style-type: none"> Comes on when the steering wheel is locked. 	<ul style="list-style-type: none"> Move the steering wheel left and right while pressing the ENGINE START/STOP button. 	—
	Shift to Park Indicator*	<ul style="list-style-type: none"> Blinks if you push the ENGINE START/STOP button to turn the engine off without the shift lever in P. 	<ul style="list-style-type: none"> Push the ENGINE START/STOP button twice after moving the shift lever to P. 	—

*1: Models with the keyless access system have an **ENGINE START/STOP** button instead of an ignition switch.

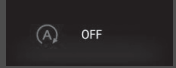

Indicator	Name	On/Blinking	Explanation	Message*
	Auto Idle Stop Indicator (Green)*	<ul style="list-style-type: none"> • Comes on when Auto Idle Stop is in operation. The engine automatically shuts off. 	<ul style="list-style-type: none"> •  Auto Idle Stop* P. 478 	
		<ul style="list-style-type: none"> • Blinks when the ambient conditions may cause the windows to fog up. • Blinks when the ambient conditions may become different from the climate control settings you have selected. • Blinks when the  (windscreen demister) button is pressed. 	<ul style="list-style-type: none"> • Depress the clutch pedal. The engine automatically restarts.  Auto Idle Stop* P. 478 	

Instrument Panel

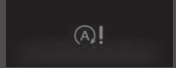

* Not available on all models

Indicator	Name	On/Blinking	Explanation	Message *
	Auto Idle Stop System Indicator (Amber)*	<ul style="list-style-type: none"> Comes on for a few seconds when you turn the ignition switch to ON *1, then goes off. 	—	—
		<ul style="list-style-type: none"> Comes on when the Auto Idle Stop system has been turned off by the Auto Idle Stop system OFF button. 	 Auto Idle Stop System ON/OFF P. 479	
		<ul style="list-style-type: none"> Blinks if there is a problem with the auto idle stop system. 	<ul style="list-style-type: none"> Blinks - Have your vehicle checked by a dealer. 	 







*1: Models with the keyless access system have an **ENGINE START/STOP** button instead of an ignition switch.

Indicator	Name	On/Blinking	Explanation	Message*
<p>Continuously variable transmission models</p>  <p>Manual transmission models</p> 	<p>Brake Depressing Indicator*</p>	<p>Electric Parking Brake System</p> <ul style="list-style-type: none"> • Comes on for a few seconds when you turn the ignition switch to ON *1, then goes off. • Blinks when the electric parking brake switch is pressed without depressing the brake pedal while the electric parking brake is in operation. <p>Automatic Brake Hold System</p> <ul style="list-style-type: none"> • Blinks when the automatic brake hold button is pressed without depressing the brake pedal while the automatic brake hold is in operation. • Blinks if the automatic brake hold is automatically cancelled while it is in operation. The beeper sounds. 	<ul style="list-style-type: none"> • Blinks while driving - Press the electric parking brake switch with the brake pedal depressed. <ul style="list-style-type: none"> ➤ Parking Brake P. 560 • Blinks while driving - Press the automatic brake hold button with the brake pedal depressed. <ul style="list-style-type: none"> ➤ Automatic Brake Hold P. 563 • Immediately depress the brake pedal. 	<p>—</p>





*1: Models with the keyless access system have an **ENGINE START/STOP** button instead of an ignition switch.

Indicator	Name	On/Blinking	Explanation	Message*
	Road Departure Mitigation Indicator*	<ul style="list-style-type: none"> • Comes on for a few seconds when you turn the ignition switch to ON *1, then goes off. • Comes on if there is a problem with the road departure mitigation system. 	<ul style="list-style-type: none"> • Stays on constantly - Have your vehicle checked by a dealer. 	



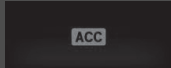



*1: Models with the keyless access system have an **ENGINE START/STOP** button instead of an ignition switch.

Indicator	Name	On/Blinking	Explanation	Message*
	Road Departure Mitigation Indicator*	<ul style="list-style-type: none"> Comes on when the road departure mitigation system shuts itself off. 	<ul style="list-style-type: none"> Stays on - The temperature inside the camera is too high. Use the climate control system to cool down the camera. The system activates when the temperature inside the camera cools down.  Front Sensor Camera* P. 501 	
			<ul style="list-style-type: none"> Stays on - The area around the camera is blocked by dirt, mud, etc. Stop your vehicle in a safe place, and wipe it off with a soft cloth. Have your vehicle checked by a dealer if the indicator and message come back on after you cleaned the area around the camera.  Front Sensor Camera* P. 501 	
			<ul style="list-style-type: none"> When the radar sensor gets dirty, stop your vehicle in a safe place, and wipe off dirt using a soft cloth. Have your vehicle checked by a dealer if the message does not disappear even after you clean the sensor cover. 	

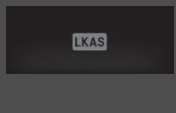
* Not available on all models

Indicator	Name	On/Blinking	Explanation	Message*
ACC	Adaptive Cruise Control (ACC) with Low Speed Follow (LSF) Indicator (Amber)*	<ul style="list-style-type: none"> Comes on for a few seconds when you turn the ignition switch to ON *, then goes off. Comes on if there is a problem with ACC with LSF. 	<ul style="list-style-type: none"> Comes on while driving - Have your vehicle checked by a dealer. 	
		<ul style="list-style-type: none"> Comes on if anything covers the radar sensor cover and prevents the sensor from detecting a vehicle in front. May come on when driving in bad weather (rain, snow, fog, etc.) ACC with LSF has been automatically cancelled. 	<ul style="list-style-type: none"> When the radar sensor gets dirty, stop your vehicle in a safe place, and wipe off dirt using a soft cloth. Have your vehicle checked by a dealer if the indicator does not go off even after you clean the sensor cover. 	
ACC	Adaptive Cruise Control (ACC) with Low Speed Follow (LSF) Indicator (Green)*	<ul style="list-style-type: none"> Comes on when you press the MAIN button. 	<ul style="list-style-type: none">  Adaptive Cruise Control (ACC) with Low Speed Follow (LSF)* P. 503 	
		<ul style="list-style-type: none"> Comes on when ACC with LSF is in operation, but the temperature inside the front sensor camera is too high. ACC with LSF cancels automatically. The beeper sounds simultaneously. 	<ul style="list-style-type: none"> Use the climate control system to cool down the camera. Goes off - The camera has been cooled down and the system activates normally. 	







*1: Models with the keyless access system have an **ENGINE START/STOP** button instead of an ignition switch.

Indicator	Name	On/Blinking	Explanation	Message*
LKAS	Lane Keeping Assist System (LKAS) Indicator (Amber)*	<ul style="list-style-type: none"> Comes on for a few seconds when you turn the ignition switch to ON *1, then goes off. Comes on if there is a problem with the LKAS. 	<ul style="list-style-type: none"> Stays on constantly - Have your vehicle checked by a dealer. 	
LKAS	Lane Keeping Assist System (LKAS) Indicator (Green)*	<ul style="list-style-type: none"> Comes on when you press the MAIN button. 	<ul style="list-style-type: none">  Lane Keeping Assist System (LKAS)* P. 543 	
		<ul style="list-style-type: none"> Comes on when the LKAS is in operation, or the LKAS button is pressed, but the temperature inside the front sensor camera is too high. The LKAS cancels automatically. The beeper sounds simultaneously. 	<ul style="list-style-type: none"> Use the climate control system to cool down the camera. Goes off - The camera has cooled down and the system activates normally.  Front Sensor Camera* P. 501 	
		<ul style="list-style-type: none"> Comes on when the area around the camera is blocked by dirt, mud, etc. Stop your vehicle in a safe place, and wipe it off with a soft cloth. May come on when driving in bad weather (rain, snow, fog, etc.) 	<ul style="list-style-type: none"> Have your vehicle checked by a dealer if the indicator and message come back on after you cleaned the area around the camera. 	





Instrument Panel

* 1: Models with the keyless access system have an **ENGINE START/STOP** button instead of an ignition switch.

* Not available on all models

Indicator	Name	On/Blinking	Explanation	Message*
	Blind Spot Information (BSI) Indicator	<ul style="list-style-type: none"> • Comes on for a few seconds when you turn the ignition switch to ON *1, then goes off. • Stays on while BSI is turned off. 	—	
		<ul style="list-style-type: none"> • Comes on when mud, snow, or ice accumulates in the vicinity of sensor. 	<ul style="list-style-type: none"> • Comes on while driving - Remove the obstacle in the vicinity of sensor.  Blind spot information (BSI) System* P. 553 	
		<ul style="list-style-type: none"> • Comes on if there is a problem with the system. 	<ul style="list-style-type: none"> • Comes on while driving - Have your vehicle checked by a dealer. 	

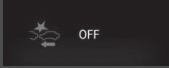

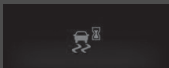

*1: Models with the keyless access system have an **ENGINE START/STOP** button instead of an ignition switch.

Indicator	Name	On/Blinking	Explanation	Message*
	Collision Mitigation Braking System (CMBS) Indicator*	<ul style="list-style-type: none"> • Comes on for a few seconds when you turn the ignition switch to ON *1, then goes off. • Comes on when you deactivate the CMBS. A driver information interface message appears for five seconds. • Comes on if there is a problem with the CMBS. 	<ul style="list-style-type: none"> • Stays on constantly without the CMBS off - Have your vehicle checked by a dealer. <ul style="list-style-type: none"> ➤ Collision Mitigation Braking System (CMBS)* P. 569 • Drive a short distance at more than 20 km/h. The indicator should go off. If it does not, have your vehicle checked by a dealer. 	  

Instrument Panel

* 1: Models with the keyless access system have an **ENGINE START/STOP** button instead of an ignition switch.

* Not available on all models

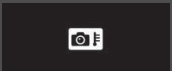

Indicator	Name	On/Blinking	Explanation	Message*
	Collision Mitigation Braking System (CMBS) Indicator*	<ul style="list-style-type: none"> Comes on when the CMBS system shuts itself off. 	<ul style="list-style-type: none"> Stays on - The area around the camera is blocked by dirt, mud, etc. Stop your vehicle in a safe place, and wipe it off with a soft cloth.  Front Sensor Camera* P. 501 	
			<ul style="list-style-type: none"> When the radar sensor gets dirty, stop your vehicle in a safe place, and wipe off dirt using a soft cloth. Have your vehicle checked by a dealer if the indicator does not go off even after you clean the sensor cover. 	
			<ul style="list-style-type: none"> Stays on - The temperature inside the camera is too high. Use the climate control system to cool down the camera. The system activates when the temperature inside the camera cools down.  Front Sensor Camera* P. 501 	

Information Display Warning and Information Messages*

The following messages appear only on the information display.

Message	Condition	Explanation
	<ul style="list-style-type: none"> Appears when there is a problem with the sensor on the battery. 	<ul style="list-style-type: none"> Stays on constantly - Have your vehicle checked by a dealer.







Models with keyless access system

Message	Condition	Explanation
	<ul style="list-style-type: none"> Appears when you close the door with the power mode in ON, without the keyless remote inside the vehicle. 	<ul style="list-style-type: none"> Disappears when you bring the keyless remote back inside the vehicle and close the door. <ul style="list-style-type: none"> ▶ Keyless Remote Reminder P. 200
	<ul style="list-style-type: none"> Appears when the keyless remote's battery becomes weak. 	<ul style="list-style-type: none"> Replace the battery as soon as possible. <ul style="list-style-type: none"> ▶ Keyless Remote* P. 662

* Not available on all models





Driver Information Interface Warning and Information Messages *

The following messages appear only on the driver information interface. Press the  (display/information) button to see the message again with the system message indicator on.

Message	Condition	Explanation
	<ul style="list-style-type: none"> • Appears if any door or the boot is not completely closed. • Appears if any door or the boot is opened while driving. The beeper sounds. 	<ul style="list-style-type: none"> • Goes off when all doors and the boot are closed.
<p>Models with parking sensor system</p> <p>*1  *2  Check System</p> <p>Models with rearview camera system</p> 	<ul style="list-style-type: none"> • Appears if there is a problem with the parking sensor system. • If there is a problem with any of the sensors, the all sensor indicator(s) comes on in red. 	<ul style="list-style-type: none"> • Check if the area around the sensor(s) is covered with mud, ice, snow, etc. If the indicator(s) stays on or the beeper does not stop even after you clean the area, have the system checked by a dealer.
<p>*1  *2  Check Charging System</p>	<ul style="list-style-type: none"> • Appears when there is a problem with the sensor on the battery. • Appears along with the battery charging system indicator when the battery is not charging. 	<ul style="list-style-type: none"> • Have your vehicle checked by a dealer. <ul style="list-style-type: none"> ➤ Checking the Battery P. 656 • Turn off the climate control system and rear defogger to reduce electricity consumption. <ul style="list-style-type: none"> ➤ If the Charging System Indicator Comes On P. 702

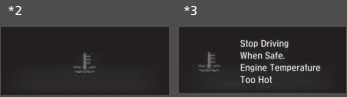
*1:Israeli, Turkish, and except Middle Eastern models

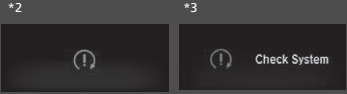





*2:Middle Eastern except Israeli and Turkish models

Message	Condition	Explanation
	<ul style="list-style-type: none"> Appears when the engine coolant temperature gets abnormally high. 	<p>➤ Overheating P. 699</p>
	<ul style="list-style-type: none"> Appears once if the outside temperature is below 3°C while the ignition switch is in ON *1. 	<ul style="list-style-type: none"> There is a possibility that the road surface is icy and slippery.
	<ul style="list-style-type: none"> Appears when the starting system has a problem. 	<p>Models without keyless access system</p> <ul style="list-style-type: none"> As a temporary measure, hold the turn the ignition switch to START  for up to 15 seconds while pressing the brake pedal and clutch pedal (manual transmission only), and manually start the engine. Have your vehicle checked by a dealer. <p>Models with keyless access system</p> <ul style="list-style-type: none"> As a temporary measure, press and hold the ENGINE START/STOP button for 15 seconds while depressing the brake pedal. Then manually start the engine. Have the vehicle checked by a dealer.

*1:Models with the keyless access system have an **ENGINE START/STOP** button instead of an ignition switch.

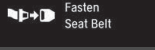
*2:Israeli, Turkish, and except Middle Eastern models











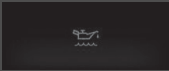
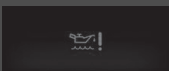

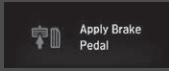
*3:Middle Eastern except Israeli and Turkish models

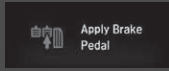
Message	Condition	Explanation
<div style="display: flex; justify-content: space-around;"> <div style="text-align: center;">*2 </div> <div style="text-align: center;">*3 </div> </div>	<ul style="list-style-type: none"> Appears when the steering wheel is locked. 	<ul style="list-style-type: none"> Move the steering wheel left and right while pressing the ENGINE START/STOP button.
<div style="display: flex; justify-content: space-around;"> <div style="text-align: center;">*2 </div> <div style="text-align: center;">*3 </div> </div>	<ul style="list-style-type: none"> Appears when you turn the ignition switch to ON *1 without fastening the driver's seat belt. 	<ul style="list-style-type: none"> Fasten the seat belt properly before you start to drive.
<div style="text-align: center;">* </div>	<ul style="list-style-type: none"> Appears when the washer fluid gets low. 	<ul style="list-style-type: none"> Refill the washer fluid.  Refilling Window Washer Fluid P. 632

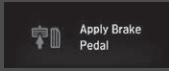
*1: Models with the keyless access system have an **ENGINE START/STOP** button instead of an ignition switch.

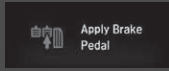

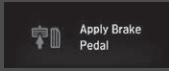

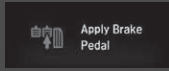





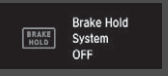

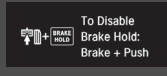

*2: Israeli, Turkish, and except Middle Eastern models

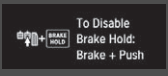
*3: Middle Eastern except Israeli and Turkish models

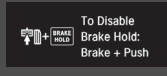
Message	Condition	Explanation		
<p>*1</p> 	<ul style="list-style-type: none"> • Appears when the engine oil level is low while the engine is running. 	<ul style="list-style-type: none"> • Appears while driving - Immediately stop in a safe place. ► If the Low Oil Level Symbol Appears* P. 709 		
<p>*1</p> 	<ul style="list-style-type: none"> • Appears when the engine is running, there is a system problem in the engine oil level sensor. 	<ul style="list-style-type: none"> • Have your vehicle checked by a dealer. 		
<table border="1" style="width: 100%;"> <tr> <td style="width: 50%; padding: 5px;"> <p>Continuously variable transmission models</p> <p>*1</p>  <p>*2</p>  </td> <td style="width: 50%; padding: 5px;"> <p>Manual transmission models</p> <p>*1</p>  <p>*2</p>  </td> </tr> </table>	<p>Continuously variable transmission models</p> <p>*1</p>  <p>*2</p> 	<p>Manual transmission models</p> <p>*1</p>  <p>*2</p> 	<ul style="list-style-type: none"> • Appears if the automatic brake hold is automatically cancelled while it is in operation. 	<ul style="list-style-type: none"> • Immediately depress the brake pedal.
<p>Continuously variable transmission models</p> <p>*1</p>  <p>*2</p> 	<p>Manual transmission models</p> <p>*1</p>  <p>*2</p> 			

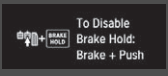

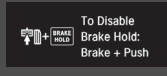

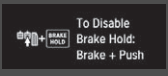
* 1: Israeli, Turkish, and except Middle Eastern models

*2: Middle Eastern except Israeli and Turkish models

Message	Condition	Explanation		
 *1  *2	<ul style="list-style-type: none"> Appears when the automatic brake hold system is turned off. 	<p>➤ Automatic Brake Hold P. 563</p>		
 *1  *2	<ul style="list-style-type: none"> Appears when the automatic brake hold button is pressed without wearing the driver's seat belt. 	<ul style="list-style-type: none"> Fasten the driver's seat belt. <p>➤ Automatic Brake Hold P. 563</p>		
<table border="1" style="width: 100%;"> <tr> <td data-bbox="97 508 325 840"> <p>Continuously variable transmission models</p>  *1  *2 </td> <td data-bbox="325 508 552 840"> <p>Manual transmission models</p>  *1  *2 </td> </tr> </table>	<p>Continuously variable transmission models</p>  *1  *2	<p>Manual transmission models</p>  *1  *2	<ul style="list-style-type: none"> Appears when the automatic brake hold button is pressed without depressing the brake pedal while the automatic brake hold is in operation. 	<ul style="list-style-type: none"> Press the automatic brake hold button with the brake pedal depressed. <p>➤ Automatic Brake Hold P. 563</p>
<p>Continuously variable transmission models</p>  *1  *2	<p>Manual transmission models</p>  *1  *2			

*1:Israeli, Turkish, and except Middle Eastern models

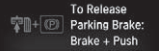

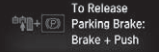
*2:Middle Eastern except Israeli and Turkish models



Message	Condition	Explanation
<p>*1  *2 </p>	<ul style="list-style-type: none"> • Appears when the parking brake is applied automatically while it is in operation. 	<ul style="list-style-type: none"> ➤ Automatic Brake Hold P. 563 ➤ Parking Brake P. 560
<p>Continuously variable transmission models</p> <p>*1  *2 </p> <p>Manual transmission models</p> <p>*1  *2 </p>	<ul style="list-style-type: none"> • Appears when the electric parking brake switch is pressed without depressing the brake pedal while the electric parking brake is in operation. 	<ul style="list-style-type: none"> • Appears while driving - Press the electric parking brake switch with the brake pedal depressed. ➤ Parking Brake P. 560

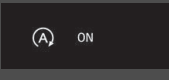
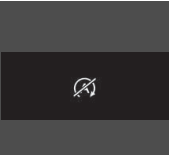

*1: Israeli, Turkish, and except Middle Eastern models

*2: Middle Eastern except Israeli and Turkish models

Models with Auto Idle Stop System

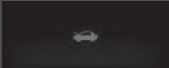

Message	Condition	Explanation
	<ul style="list-style-type: none"> • Appears when you turn the Auto Idle Stop system on. 	<p>➤ Auto Idle Stop* P. 478</p>
	<ul style="list-style-type: none"> • Appears when Auto Idle Stop does not activate for some reason. • Appears when the engine restarts automatically. • Appears when the battery temperature is around 5°C or lower. 	<p>➤ Auto Idle Stop Activates When: P. 480</p>
	<ul style="list-style-type: none"> • Appears when Auto Idle Stop does not activate because the battery charge level is low. • Appears when the battery is low performance. 	<ul style="list-style-type: none"> • Comes on even though the battery is fully charged - The system may not read the battery amount correctly. Drive for a few minutes. • Comes on after charging the battery or jump starting - Disconnect the negative ⊖ cable once and reconnect it again to the battery. Drive a few minutes. <p>➤ Auto Idle Stop* P. 478</p>

Message	Condition	Explanation
	<ul style="list-style-type: none"> • Appears when the Auto Idle Stop does not activate because the battery charge level is low performance. • Appears when the battery is low performance. 	<p>► Auto Idle Stop Activates When: P. 480</p> <ul style="list-style-type: none"> • The engine restarts automatically in a few seconds.
	<ul style="list-style-type: none"> • Appears when Auto Idle Stop does not activate because the engine coolant temperature is low or high. 	<p>► Auto Idle Stop Activates When: P. 480</p>
	<ul style="list-style-type: none"> • Appears when Auto Idle Stop does not activate because the climate control system is in use, and the difference between the set temperature and actual interior temperature becomes significant. 	<p>► Auto Idle Stop Activates When: P. 480</p>
	<ul style="list-style-type: none"> • Appears when the bonnet is opened. 	<ul style="list-style-type: none"> • Close the bonnet.





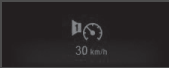

Message	Condition	Explanation
	<ul style="list-style-type: none"> Appears when you move the shift lever from [N] to any other position without depressing the clutch pedal while Auto Idle Stop is in operation. 	<ul style="list-style-type: none"> The engine will not start even when the battery charge becomes low. Shift to [N] to avoid the battery charge becomes low. <ul style="list-style-type: none"> ➤ Auto Idle Stop* P. 478
	<ul style="list-style-type: none"> Appears in white when you turn the ignition switch to START [III]*1 before fully depressing the clutch pedal. Appears in white when the ambient conditions may cause the windows to fog up or may become different from the climate control settings you have selected while Auto Idle Stop is in operation. 	<ul style="list-style-type: none"> Depress the clutch pedal.
	<ul style="list-style-type: none"> Appears in amber when the following conditions are kept while Auto Idle Stop is in operation: <ul style="list-style-type: none"> - You are not wearing a seat belt. - The shift lever is in any position except [N]. 	<ul style="list-style-type: none"> Depress the clutch pedal. Wear the seat belt immediately, and continue to keep the shift lever in [N] next time Auto Idle Stop activates.

*1: Models with the keyless access system have an **ENGINE START/STOP** button instead of an ignition switch.

Models with speed alarm



Message	Condition	Explanation
	<ul style="list-style-type: none"> Appears when the vehicle speed reaches the set speed. You can set two different speeds for the alarm. 	<p> Speed Alarm* P. 159</p>

Models without keyless access system

Message	Condition	Explanation
<p>*1  *2 </p>	<ul style="list-style-type: none"> Appears when you open the driver's door while the ignition key is in ACCESSORY I. 	<ul style="list-style-type: none"> Turn the ignition switch to LOCK 0, then remove the key.
<p>*1  *2 </p>	<ul style="list-style-type: none"> Appears when the ignition key is turned to ACCESSORY I from ON II. (The driver's door is closed.) 	<p>—</p>
<p>*1  *2 </p>	<ul style="list-style-type: none"> Appears when you open the driver's door while the ignition key is in LOCK 0. 	<ul style="list-style-type: none"> Remove the key from the ignition switch.

*1:Israeli, Turkish, and except Middle Eastern models

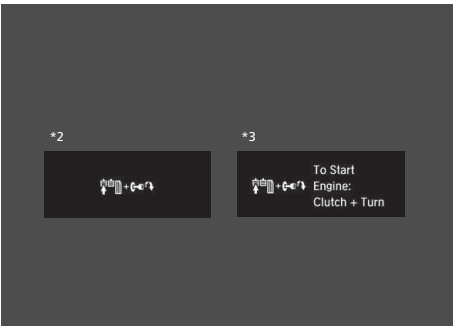
*2:Middle Eastern except Israeli and Turkish models



Message	Condition	Explanation
	<ul style="list-style-type: none"> Appears in white when you turn the ignition switch to START *1 before fully depressing the clutch pedal. 	<ul style="list-style-type: none"> Turn the ignition switch after fully depressing the clutch pedal.
	<p>Models with Auto Idle Stop System</p> <ul style="list-style-type: none"> Appears in amber when the engine does not restart automatically due to the following reasons: <ul style="list-style-type: none"> - The bonnet is open. - There is a problem in the system that disables Auto Idle Stop. 	<ul style="list-style-type: none"> Follow the normal procedure to start the engine. <ul style="list-style-type: none"> ➤ Starting the Engine P. 458

*1: Models with the keyless access system have an **ENGINE START/STOP** button instead of an ignition switch.

*2: Israeli, Turkish, and except Middle Eastern models



*3: Middle Eastern except Israeli and Turkish models

Models with keyless access system

Message	Condition	Explanation
<p>*1 *2</p> 	<ul style="list-style-type: none"> • Appears as soon as a problem is detected in the keyless access system or keyless starting system. 	<ul style="list-style-type: none"> • Have your vehicle checked by a dealer.
<p>*1 *2</p> 	<ul style="list-style-type: none"> • Appears when you close the door with the power mode on without the keyless remote inside the vehicle. 	<ul style="list-style-type: none"> • The message goes away when you bring the keyless remote back inside the vehicle, and close the door. ➤ Keyless Remote Reminder P. 200
<p>*1 *2</p> 	<ul style="list-style-type: none"> • Appears when the keyless remote battery becomes weak. 	<ul style="list-style-type: none"> • Replace the battery as soon as possible. ➤ Keyless Remote* P. 662

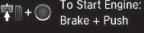

*1:Israeli, Turkish, and except Middle Eastern models

*2:Middle Eastern except Israeli and Turkish models

Message		Condition	Explanation
<div style="border: 1px solid black; padding: 5px; margin-bottom: 10px;">Continuously variable transmission models</div> <p>*1</p>  <p>*2</p> 	<div style="border: 1px solid black; padding: 5px; margin-bottom: 10px;">Manual transmission models</div> <p>*1</p>  <p>*2</p> 	<ul style="list-style-type: none"> • Appears after you set the power mode to ACCESSORY or ON. <div style="background-color: #cccccc; padding: 5px; margin-bottom: 5px;">Models with Auto Idle Stop System</div> <ul style="list-style-type: none"> • Appears in amber when the engine does not restart automatically due to the following reason: <ul style="list-style-type: none"> - The bonnet is open. - There is a problem in the system that disables Auto Idle Stop. 	<p>➤ Starting the Engine P. 461</p>

*1:Israeli, Turkish, and except Middle Eastern models





*2:Middle Eastern except Israeli and Turkish models

Message	Condition	Explanation
<p>*1 *2</p> 	<ul style="list-style-type: none"> • Appears when the power mode is ACCESSORY. 	<p>—</p>
<p>*1 *2</p> 	<ul style="list-style-type: none"> • Appears after the driver's door is opened when the power mode is ACCESSORY. 	<ul style="list-style-type: none"> • Press the ENGINE START/STOP button twice with your foot off the brake pedal (continuously variable transmission) or the clutch pedal (manual transmission) to change the power mode to VEHICLE OFF (LOCK).
<p>*1 *2</p> 	<ul style="list-style-type: none"> • Appears if the keyless remote's battery is too weak to start the engine or the key is not within operating range to start the engine. The beeper sounds six times. 	<ul style="list-style-type: none"> • Bring the keyless remote in front of the ENGINE START/STOP button to be touched with. <ul style="list-style-type: none"> ► If the Keyless Remote Battery is Weak P. 693



*1:Israeli, Turkish, and except Middle Eastern models

*2:Middle Eastern except Israeli and Turkish models

Models with ACC with LSF





Message	Condition	Explanation
	<ul style="list-style-type: none"> Appears when the system predicts the vehicle cutting in in front of you from the right and decrease your vehicle speed according to the cut-in vehicle. 	<ul style="list-style-type: none"> The system automatically keeps a safe distance from the cut-in vehicle when the system predicts the cutting in. <ul style="list-style-type: none"> ▶ How the System Activates P. 533
	<ul style="list-style-type: none"> Appears when the system predicts the vehicle cutting in in front of you from the left and decrease your vehicle speed according to the cut-in vehicle. 	<ul style="list-style-type: none"> The system automatically keeps a safe distance from the cut-in vehicle when the system predicts the cutting in. <ul style="list-style-type: none"> ▶ How the System Activates P. 533
	<ul style="list-style-type: none"> Appears when ACC with LSF has been automatically cancelled. 	<ul style="list-style-type: none"> You can resume the set speed after the condition that caused ACC with LSF to cancel improves. Press the RES/+ button. <ul style="list-style-type: none"> ▶ Adaptive Cruise Control (ACC) with Low Speed Follow (LSF)* P. 503
	<ul style="list-style-type: none"> Appears when the distance between your vehicle and the vehicle ahead of you is too close while ACC with LSF is in operation. 	<ul style="list-style-type: none"> ACC with LSF has been automatically cancelled. <ul style="list-style-type: none"> ▶ Adaptive Cruise Control (ACC) with Low Speed Follow (LSF)* P. 503
	<ul style="list-style-type: none"> Appears when pressing the -/SET button while the distance between your vehicle and the vehicle ahead of you is too close. 	<ul style="list-style-type: none"> ACC with LSF cannot be set. <ul style="list-style-type: none"> ▶ Adaptive Cruise Control (ACC) with Low Speed Follow (LSF)* P. 503

Models with ACC with LSF

Message	Condition	Explanation
	<ul style="list-style-type: none"> Appears when the driver's seat belt is unfastened while your vehicle is automatically stopped by ACC with LSF. 	<ul style="list-style-type: none"> ACC with LSF has been automatically cancelled. <ul style="list-style-type: none"> ► Adaptive Cruise Control (ACC) with Low Speed Follow (LSF)* P. 503
	<ul style="list-style-type: none"> Appears when pressing the -/SET button while the driver's seat belt is unfastened. 	<ul style="list-style-type: none"> ACC with LSF cannot be set. <ul style="list-style-type: none"> ► Adaptive Cruise Control (ACC) with Low Speed Follow (LSF)* P. 503
	<ul style="list-style-type: none"> Appears when the vehicle in front of you starts moving while your vehicle is stopped automatically by ACC with LSF. 	<ul style="list-style-type: none"> Either press the RES/+ button or -/SET button, or depress the accelerator pedal. <ul style="list-style-type: none"> ► Adaptive Cruise Control (ACC) with Low Speed Follow (LSF)* P. 503





* Not available on all models

Models with ACC with LSF

Message	Condition	Explanation
	<ul style="list-style-type: none"> Appears when pressing the –/SET button while the shift lever is in any position other than D or S. 	<ul style="list-style-type: none"> ACC with LSF cannot be set. <ul style="list-style-type: none"> ➤ Adaptive Cruise Control (ACC) with Low Speed Follow (LSF)* P. 503
 	<ul style="list-style-type: none"> Appears when the vehicle is stopped on a very steep slope while ACC with LSF is in operation. 	<ul style="list-style-type: none"> ACC with LSF has been automatically cancelled. <ul style="list-style-type: none"> ➤ Adaptive Cruise Control (ACC) with Low Speed Follow (LSF)* P. 503
 	<ul style="list-style-type: none"> Appears when pressing the –/SET button while the vehicle is stopped on a very steep slope. 	<ul style="list-style-type: none"> ACC with LSF cannot be set. <ul style="list-style-type: none"> ➤ Adaptive Cruise Control (ACC) with Low Speed Follow (LSF)* P. 503

Instrument Panel

Models with ACC with LSF

Message	Condition	Explanation
	<ul style="list-style-type: none"> Appears when the parking brake is applied automatically while ACC with LSF is in operation. 	<ul style="list-style-type: none"> ACC with LSF has been automatically cancelled. <ul style="list-style-type: none"> ➤ Adaptive Cruise Control (ACC) with Low Speed Follow (LSF)* P. 503 ➤ Parking Brake P. 560
	<ul style="list-style-type: none"> Appears when pressing the -/SET button while the parking brake is applied. 	<ul style="list-style-type: none"> ACC with LSF cannot be set. <ul style="list-style-type: none"> ➤ Adaptive Cruise Control (ACC) with Low Speed Follow (LSF)* P. 503 ➤ Parking Brake P. 560
<p>Continuously variable transmission models</p> 	<ul style="list-style-type: none"> Appears when pressing the -/SET button while the vehicle is moving and the brake pedal is depressed. 	<ul style="list-style-type: none"> ACC with LSF cannot be set. <ul style="list-style-type: none"> ➤ Adaptive Cruise Control (ACC) with Low Speed Follow (LSF)* P. 503
<p>Manual transmission models</p> 		
	<ul style="list-style-type: none"> Appears if ACC with LSF is cancelled while your vehicle is automatically stopped by ACC with LSF. 	<ul style="list-style-type: none"> Immediately depress the brake pedal.

Instrument Panel



* Not available on all models

Message	Condition	Explanation
	<ul style="list-style-type: none"> Flashes when the system senses a likely collision with a vehicle in front of you. 	<ul style="list-style-type: none"> Take appropriate action to prevent a collision (apply the brakes, change lanes, etc.) <ul style="list-style-type: none"> ➤ Adaptive Cruise Control (ACC) with Low Speed Follow (LSF)* P. 503 ➤ Collision Mitigation Braking System (CMBS)* P. 569

Models with LKAS

Message	Condition	Explanation
	<p>Lane Keeping Assist System (LKAS)</p> <ul style="list-style-type: none"> Appears when the vehicle is driving out of a detected lane. The steering wheel vibrates rapidly. 	<ul style="list-style-type: none"> Keep the vehicle within the lane you are driving. <ul style="list-style-type: none"> ➤ Lane Keeping Assist System (LKAS)* P. 543
	<p>Road Departure Mitigation System</p> <ul style="list-style-type: none"> Appears when the vehicle is driving out of a detected lane. <ul style="list-style-type: none"> When you selected Warning Only <ul style="list-style-type: none"> The steering wheel vibrates rapidly when the vehicle is drifting out of a detected lane. When you selected Early, Normal or Delayed <ul style="list-style-type: none"> The steering wheel vibrates rapidly when the vehicle is drifting out of a detected lane. The system also steers the vehicle to help you remain within your driving lane. 	<ul style="list-style-type: none"> Keep the vehicle within the lane you are driving. <ul style="list-style-type: none"> ➤ Road Departure Mitigation System* P. 532 You can change the setting for the road departure mitigation system. Normal, Delayed, and Warning Only can be selected. <ul style="list-style-type: none"> ➤ Customized Features P. 359
	<ul style="list-style-type: none"> Blinks when you fail to steer the vehicle. The beeper sounds simultaneously. 	<ul style="list-style-type: none"> Operate the steering wheel to resume the LKAS.

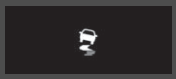
Models with ACC with LSF

Message	Condition	Explanation
	<ul style="list-style-type: none"> Appears if the VSA or traction control function operates while ACC is in operation. 	<ul style="list-style-type: none"> ACC has been automatically cancelled. <ul style="list-style-type: none"> ➤ Adaptive Cruise Control (ACC) with Low Speed Follow (LSF)* P. 503
	<ul style="list-style-type: none"> Appears when the speed of the vehicle is too high for you to set ACC. 	<ul style="list-style-type: none"> Reduce the speed, then set ACC. <ul style="list-style-type: none"> ➤ Adaptive Cruise Control (ACC) with Low Speed Follow (LSF)* P. 503
	<ul style="list-style-type: none"> Appears when ACC is cancelled due to excessive high vehicle speed. 	<ul style="list-style-type: none"> Reduce the speed, then reset ACC. <ul style="list-style-type: none"> ➤ Adaptive Cruise Control (ACC) with Low Speed Follow (LSF)* P. 503
	<ul style="list-style-type: none"> Appears when the speed of the vehicle is too low for you to set ACC. 	<ul style="list-style-type: none"> Raise the speed, then set ACC. <ul style="list-style-type: none"> ➤ Adaptive Cruise Control (ACC) with Low Speed Follow (LSF)* P. 503
	<ul style="list-style-type: none"> Appears when ACC is cancelled due to excessive low vehicle speed. 	<ul style="list-style-type: none"> Raise the speed, then reset ACC. <ul style="list-style-type: none"> ➤ Adaptive Cruise Control (ACC) with Low Speed Follow (LSF)* P. 503
	<p>Manual transmission models</p> <ul style="list-style-type: none"> Appears when pressing the RES/+ or -/SET button while the vehicle is moving and the clutch pedal is depressed. 	<ul style="list-style-type: none"> ACC cannot be set. <ul style="list-style-type: none"> ➤ Adaptive Cruise Control (ACC) with Low Speed Follow (LSF)* P. 503
	<p>Manual transmission models</p> <ul style="list-style-type: none"> Appears when the clutch pedal is applied too long while ACC is in operation. 	<ul style="list-style-type: none"> ACC cannot be set. <ul style="list-style-type: none"> ➤ Adaptive Cruise Control (ACC) with Low Speed Follow (LSF)* P. 503

* Not available on all models

Models with light control system

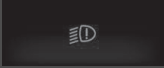
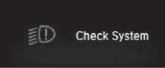
Message	Condition	Explanation
<div style="display: flex; justify-content: space-around;"> <div style="text-align: center;"> <p>*1</p>  </div> <div style="text-align: center;"> <p>*2</p>  </div> </div>	<ul style="list-style-type: none"> Appears if there is a problem with the light control system. 	<ul style="list-style-type: none"> Appears while driving - Manually turn the lights on, and have your vehicle checked by a dealer.

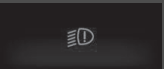
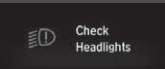

Models with LED headlights

Message	Condition	Explanation
<div style="display: flex; justify-content: space-around;"> <div style="text-align: center;"> <p>*1</p>  </div> <div style="text-align: center;"> <p>*2</p>  </div> </div>	<ul style="list-style-type: none"> Appears if there is a problem with the headlights. 	<ul style="list-style-type: none"> Appears while driving - The headlights may not be on. When conditions allow you to drive safely, have your vehicle checked by a dealer as soon as possible.

*1:Israeli, Turkish, and except Middle Eastern models

*2:Middle Eastern except Israeli and Turkish models

Continuously variable transmission models

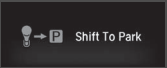
Message	Condition	Explanation
<p>*1 </p> <p>*2 </p>	<ul style="list-style-type: none"> • Appears when the transmission fluid temperature is too high. 	<ul style="list-style-type: none"> • Stop in a safe place and move the shift position to P. Let the engine idle until the message disappears.
<p>*1 </p> <p>*2 </p>	<p>Models with Auto Idle Stop System</p> <ul style="list-style-type: none"> • Appears if you press the ENGINE START/STOP button to turn the engine off without the shift lever in P. • Appears when the engine stops without the shift lever in P, and does not restart automatically. • Appears if you open the bonnet while Auto Idle Stop activates. 	<ul style="list-style-type: none"> • Move the shift lever to P, then push the ENGINE START/STOP button twice. • If you want to set the power mode to ON, move the shift lever to P. • If you want to start the engine, follow the normal procedure. <ul style="list-style-type: none"> ► Starting the Engine P. 458, 461

* 1:Israeli, Turkish, and except Middle Eastern models

*2:Middle Eastern except Israeli and Turkish models

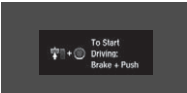

Models with remote engine starter

Message	Condition	Explanation
	<ul style="list-style-type: none"> • Appears when you unlock and open the driver's door while the engine is running by remote engine start. 	<p>➤ Remote Engine Start with Vehicle Feedback* P. 463</p>

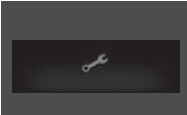
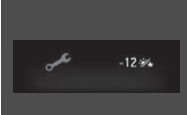
Models with service reminder system

Message	Condition	Explanation
	<ul style="list-style-type: none"> • Appears when any of the service items is required in less than 30 days. 	<ul style="list-style-type: none"> • The remaining days will be counted down per day. <p>➤ Service Reminder System* P. 601</p>
	<ul style="list-style-type: none"> • Appears when any of the service items is required in less than 10 days. 	<ul style="list-style-type: none"> • Have the indicated service performed as soon as possible. <p>➤ Service Reminder System* P. 601</p>
	<ul style="list-style-type: none"> • Appears when the indicated maintenance service is still not done after the remaining time. 	<ul style="list-style-type: none"> • Your vehicle has passed the service required point. Immediately have the service performed and make sure to reset the service reminder. <p>➤ Service Reminder System* P. 601</p>

Models with oil monitor system

Message	Condition	Explanation
	<ul style="list-style-type: none"> Appears when the maintenance service item which distance to the next maintenance period is less than 3,000 km. 	<ul style="list-style-type: none"> The remaining days will be counted down per 10 kilometres ➤ Oil Monitor System* P. 606
	<ul style="list-style-type: none"> Appears when the maintenance service item which distance to the next maintenance period is less than 1,000 km. 	<ul style="list-style-type: none"> Have the indicated service performed as soon as possible. ➤ Oil Monitor System* P. 606
	<ul style="list-style-type: none"> Appears when the indicated maintenance service is still not done after the remaining distance reaches 0. 	<ul style="list-style-type: none"> Your vehicle has passed the service required point. Immediately have the service performed and make sure to reset the oil monitor. ➤ Oil Monitor System* P. 606

* Not available on all models

Models with auto high-beam system

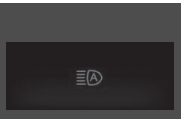
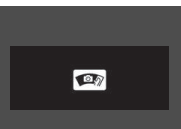
Message	Condition	Explanation
	<ul style="list-style-type: none"> Appears if there is a problem with the auto high-beam system. 	<ul style="list-style-type: none"> Manually operate the headlight switch. If you are driving with the high-beam headlights when this happens, the headlights are changed to low beams.
	<ul style="list-style-type: none"> Appears when the area around the camera on the windshield is blocked by dirt, mud, etc. 	<ul style="list-style-type: none"> Stop your vehicle in a safe place, and wipe it off with a soft cloth. If the message does not disappear after cleaning the lens, have your vehicle checked by a dealer.

Models with rear seatbelt reminder

Message	Condition	Explanation
	<ul style="list-style-type: none"> Appears when any of the rear seat belts are latched or unlatched, or either rear door is opened and closed. 	<p>➤ Seat Belt Reminder P. 43</p>

Models with colour audio system with driver information interface

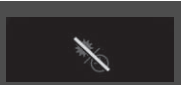
Message	Condition	Explanation
	<ul style="list-style-type: none"> Appears while you are customizing the settings and the shift lever is moved out of P. 	<p>➤ Customized Features P. 161</p>

Gauges

Gauges include the speedometer, tachometer, fuel gauge, and related indicators. They are displayed when the ignition switch is in ON *1.

■ Speedometer

Displays your driving speed in km/h.

■ Tachometer

Shows the number of engine revolutions per minute.

■ Fuel Gauge

Displays the amount of fuel left in the fuel tank.



■ Temperature Gauge

Displays the temperature of the engine coolant.

*1: Models with the keyless access system have an **ENGINE START/STOP** button instead of an ignition switch.

» Fuel Gauge

NOTICE

You should refuel when the reading approaches  or . Running out of fuel can cause the engine to misfire, damaging the catalytic converter.

The actual amount of remaining fuel may differ from the fuel gauge reading.

» Temperature Gauge

NOTICE

Driving with the temperature gauge pointer in the upper zone can cause serious engine damage. Pull safely to the side of the road and allow engine temperature to return to normal.

➤ **Overheating** P. 699

Information Display*

The information display shows the odometer, trip meter, and other gauges.

Switching the Display

Press the  (TRIP) knob to change the display.

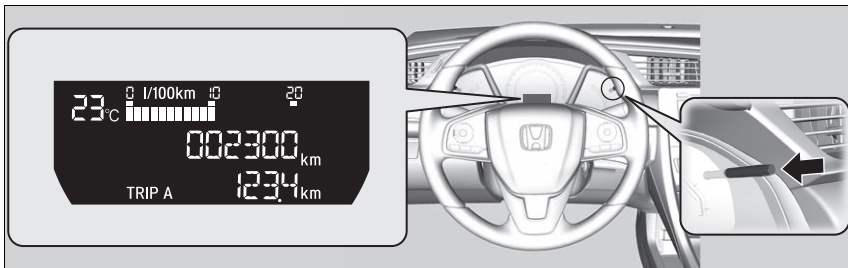

Odometer

Shows the total number of kilometres that your vehicle has accumulated.

Switching the Display

Each time you press the  knob, the information display changes as follows:

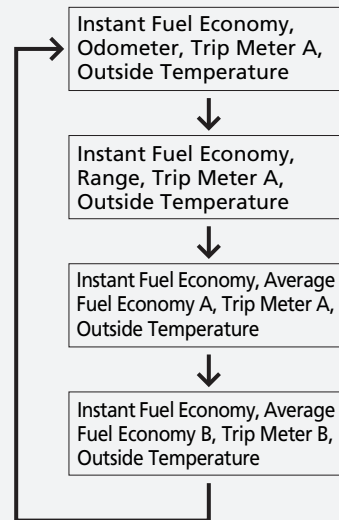

■ Trip Meter

Shows the total number of kilometres driven since the last reset. Meters A and B can be used to measure two separate trips.

■ Resetting a trip meter

To reset a trip meter, display it, then press and hold the  knob. The trip meter is reset to **0.0**.

■ Average Fuel Economy

Shows the estimated average fuel economy of each trip meter in l/100 km. The display is updated at set intervals. When a trip meter is reset, the average fuel economy is also reset.

■ Instant Fuel Economy Gauge

Shows the instant fuel economy as a bar graph in l/100km.

■ Range



Shows the estimated distance you can travel on the remaining fuel. This distance is estimated from the fuel economy of your previous trips.

■ Outside Temperature

Shows the outside temperature in Celsius.

■ Adjusting the outside temperature indicator

Adjust the temperature reading up to $\pm 3^{\circ}\text{C}$ if the temperature reading seems incorrect.

1. Turn the ignition switch to ON *1.
2. Press and hold the  (**TRIP**) knob for 10 seconds or more while the outside temperature is shown on the information display.
 - The information display goes into temperature adjustment mode. The display starts showing from -3°C to $+3^{\circ}\text{C}$.
3. Release the  knob when the right adjustment amount is shown.
 - The adjustment is complete.

» Outside Temperature

The temperature sensor is in the front bumper. Road heat and exhaust from another vehicle can affect the temperature reading when your vehicle speed is less than 30 km/h.

It may take several minutes for the display to be updated after the temperature reading has stabilized.

*1: Models with the keyless access system have an **ENGINE START/STOP** button instead of an ignition switch.



Driver Information Interface *

The driver information interface shows the odometer, trip meter, outside temperature indicator, and other gauges.

It also displays important messages such as warnings and other helpful information.

Switching the Display

Main displays

Press the  (display/information) button, and then press  or  to change the display. Press **ENTER** to see detailed information.

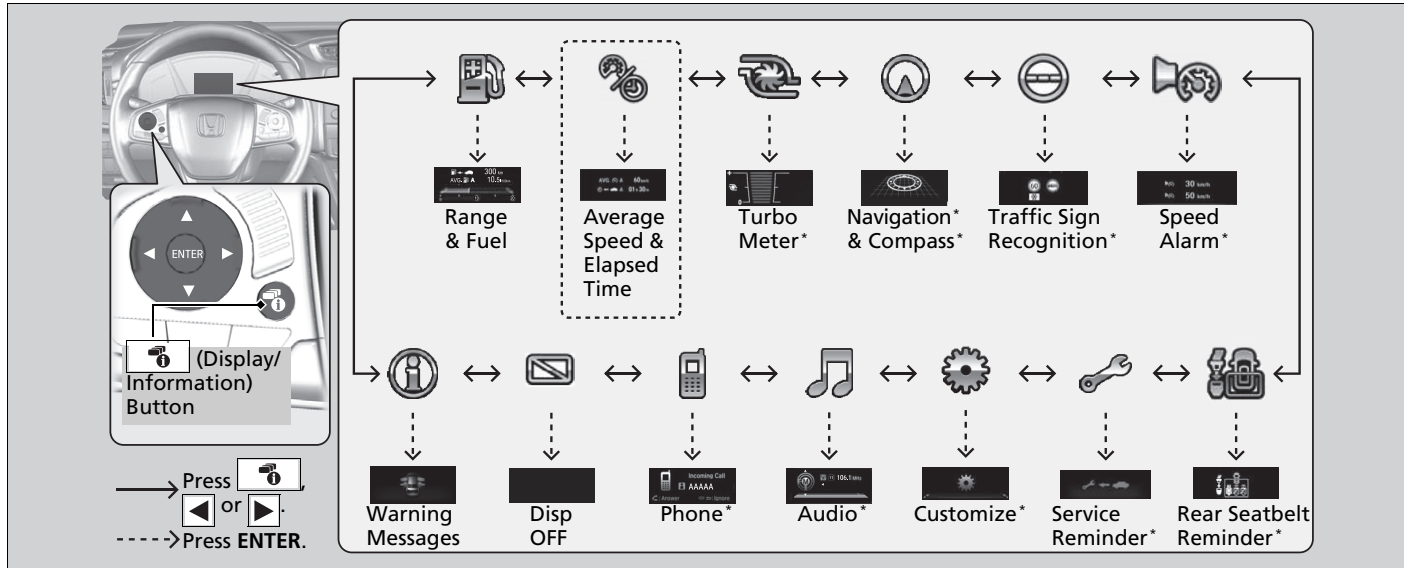

Instrument Panel

* Not available on all models

■ Trip computer

Press the  (TRIP) knob to change display.

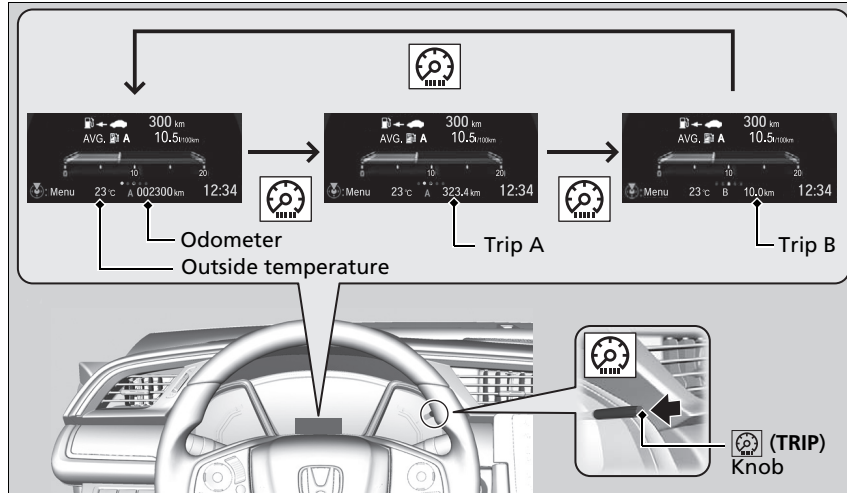

■ Odometer

Shows the total number of kilometres that your vehicle has accumulated.

■ Trip Meter

Shows the total number of kilometres driven since the last reset. Meters A and B can be used to measure two separate trips.

▶▶ Trip Meter

Switch between trip meter A and trip meter B by pressing the  knob.

■ Resetting a trip meter

To reset a trip meter, display it, then press and hold the  knob. The trip meter is reset to **0.0**.

■ Average Fuel Economy

Shows the estimated average fuel economy of each trip meter in l/100 km. The display is updated at set intervals. When a trip meter is reset, the average fuel economy is also reset.

■ Range

Shows the estimated distance you can travel on the remaining fuel. This distance is estimated from the fuel economy of your previous trips.

■ Elapsed Time

Shows the time elapsed since the last time Trip A or Trip B was reset.

■ Average Speed

Shows the average speed in km/h since the last time Trip A or Trip B was reset.

■ Instant Fuel Economy Gauge

Shows the instant fuel economy as a bar graph in l/100 km.

■ Engine Oil Life*

Shows the remaining oil life and service reminder.

 **Service Reminder System*** P. 601

* Not available on all models

⌘ Average Fuel Economy

You can change when to reset the average fuel economy.

 **Customized Features** P. 161, 359

⌘ Elapsed Time

You can change when to reset the elapsed time.

 **Customized Features** P. 161, 359

⌘ Average Speed

You can change when to reset the average speed.

 **Customized Features** P. 161, 359

Continued

■ Outside Temperature

Shows the outside temperature in Celsius.

If the outside temperature has been below 3°C at the time you set the power mode to ON, the outside temperature indicator blinks for ten seconds.

■ Adjusting the outside temperature display

Adjust the temperature reading up to $\pm 3^{\circ}\text{C}$ if the temperature reading seems incorrect.

■ Turbo Meter *

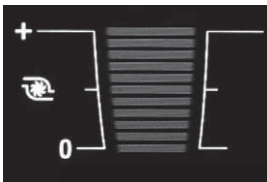

When the turbo charger is activated, this meter shows the boost pressure.

■ Traffic Sign Recognition *

Shows the traffic sign recognition.

■ Rear Seatbelt Reminder *

Shows the rear seatbelt reminder.

▶▶ Outside Temperature

The temperature sensor is in the front bumper. Road heat and exhaust from another vehicle can affect the temperature reading when your vehicle speed is less than 30 km/h.

It may take several minutes for the display to be updated after the temperature reading has stabilized.

Use the Driver Information Interface's customized features to correct the temperature.

▶▶ **Customized Features** P. 161, 359

Speed Alarm*

Sets the speed alarm on and changes the speed alarm setting.

Each time you press the ▲/▼ button, the speed alarm setting changes as follows:

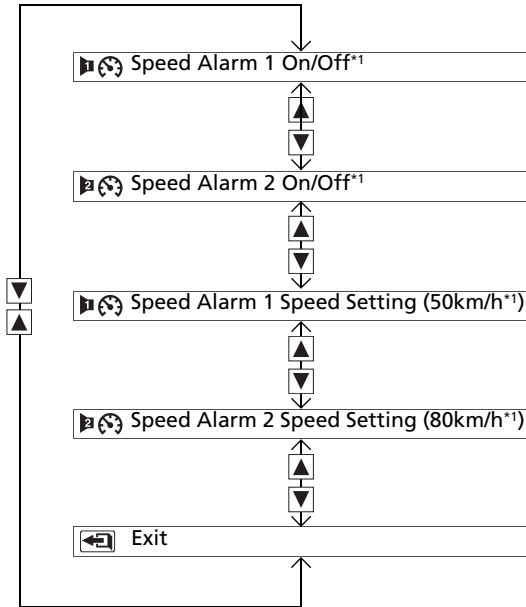

*1: Default Setting

* Not available on all models

■ Turn-by-Turn Directions *

Shows you turn-by-turn driving directions to your destination linked with the navigation system.

➤ **Refer to the Navigation System Manual**

■ Audio *

Show the current audio information.

➤ **Audio System Basic Operation** P. 286

■ Phone *

Show the current phone information.

➤ **Hands-Free Telephone System** P. 394

▶▶ Turn-by-Turn Directions *

The driver information interface shows a compass when the route guidance is not used.

You can select whether the turn-by-turn display comes on during the route guidance.





➤ **Customized Features** P. 161, 359

Models with colour audio system with driver information interface

Customized Features

Use the driver information interface to customize certain features.

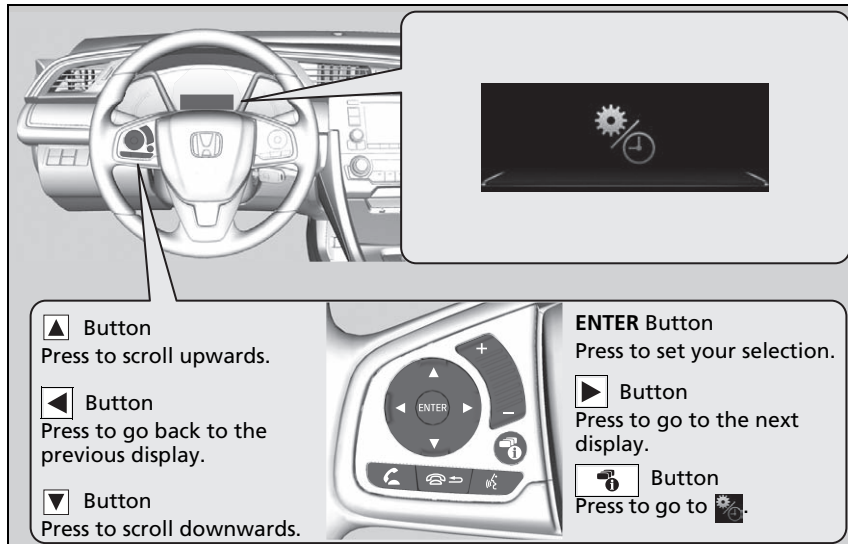

How to customize

Select the  (Customize Settings) screen by pressing the  button while the ignition switch is in ON *1, and the vehicle is at a complete stop, and the shift lever is in  (continuously variable transmission), and the parking brake is set (manual transmission). Select , then press the **ENTER** button.



*1: Models with the keyless access system have an **ENGINE START/STOP** button instead of an ignition switch.

Customized Features

To customize other features, press the / button.

 **List of customizable options** P. 164

 **Example of customization settings** P. 167

When you customize settings:

Models with continuously variable transmission
Shift to .

Models with manual transmission
Set the parking brake.

■ **Customization Flow**

Press the  button.

Instrument Panel

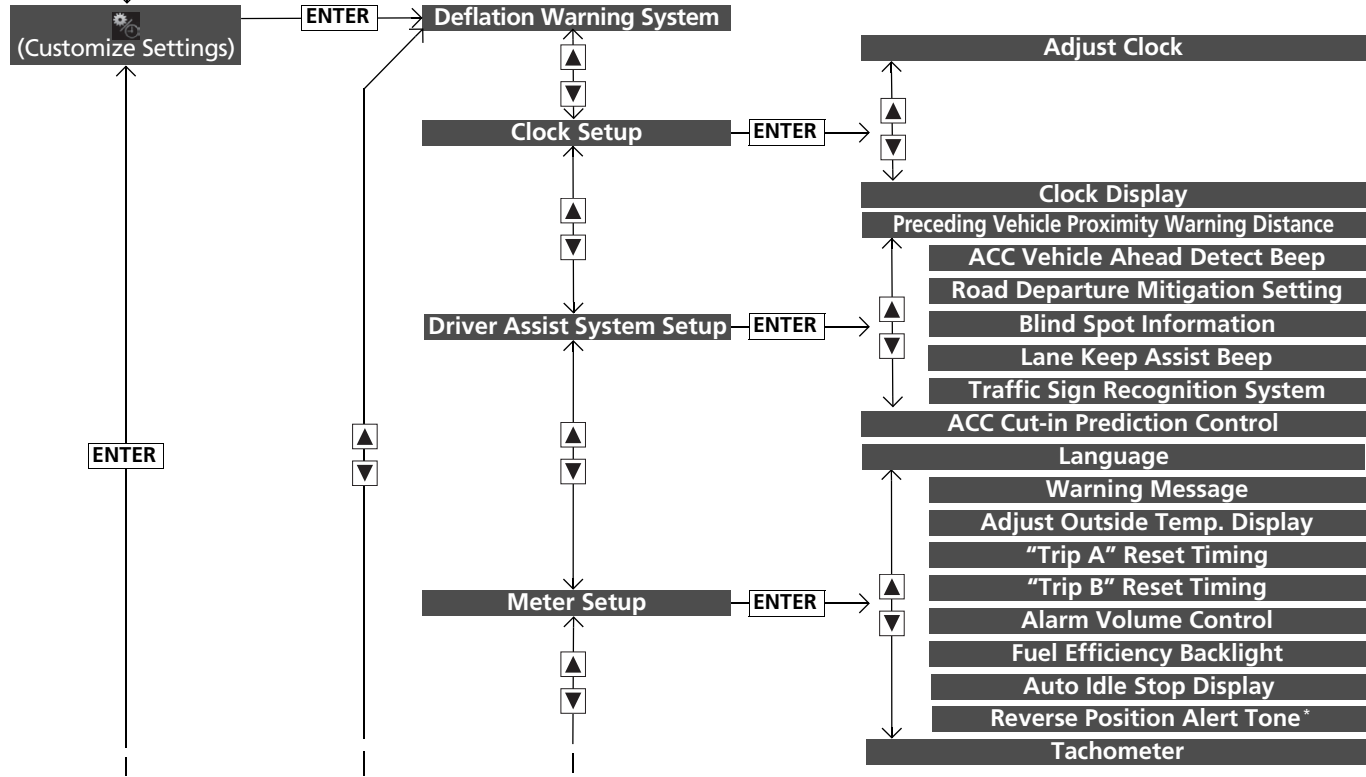

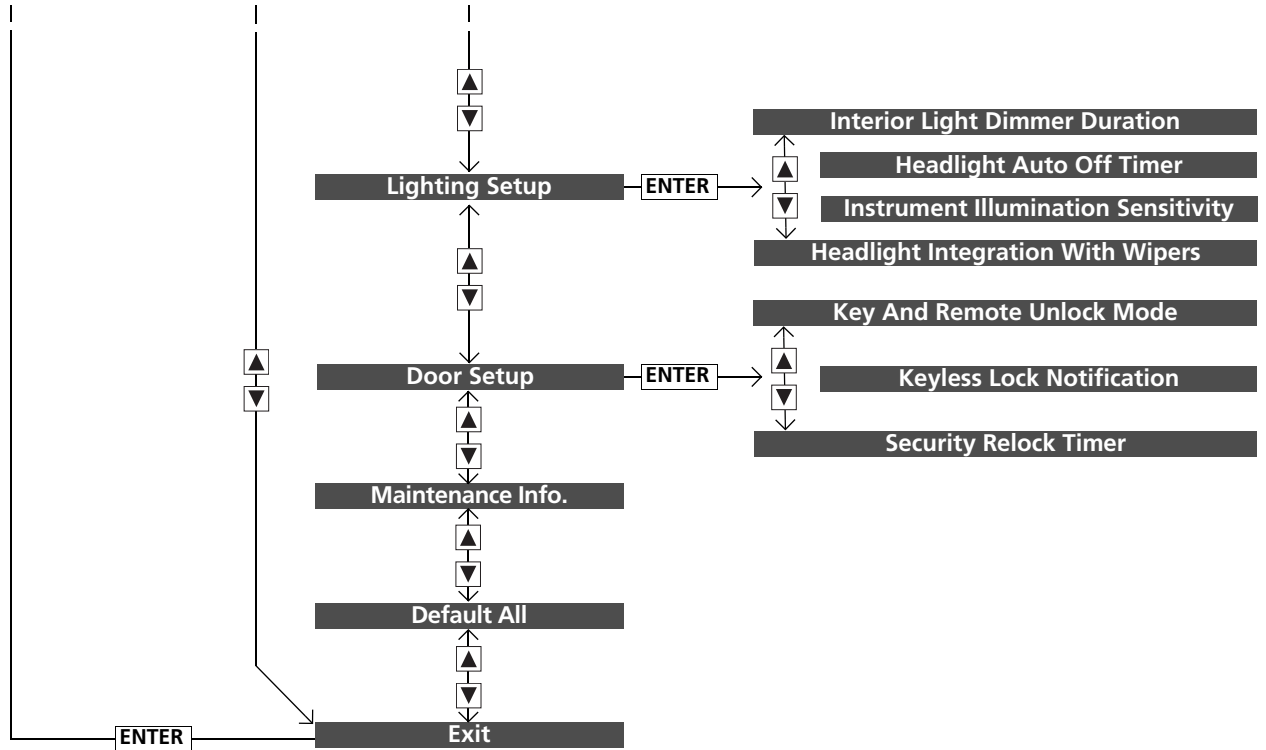

■ List of customizable options

Setup Group	Customizable Features	Description	Selectable settings
Deflation Warning System	—	Initialises the deflation warning system.	Cancel/Initialise
Clock Setup	Adjust Clock	Adjust Clock. ▶ Clock P. 170	—
	Clock Display	Selects the digital clock display from 12H to 24H.	12h^{*1}/24h
Driver Assist System Setup	Preceding Vehicle Proximity Warning Distance	Changes the distance at which CMBS alerts.	Far/Normal^{*1}/Near
	ACC Vehicle Ahead Detect Beep	Causes the system to beep when the system detects a vehicle, or when the vehicle goes out of ACC range.	ON/OFF^{*1}
	Road Departure Mitigation Setting	Changes the setting for the road departure mitigation system.	Normal/Delayed^{*1}/Warning Only/Early
	Blind Spot Information	Changes the setting for the blind spot information.	Audible And Visual Alert^{*1}/ Visual Alert Only/OFF
	Lane Keep Assist Beep	Causes the system to beep when the LKAS is suspended.	ON/OFF^{*1}
	Traffic Sign Recognition System	Selects whether the traffic sign recognition is displayed on the driver information interface.	Small Icons ON/Small Icons OFF^{*1}
ACC Cut-in Prediction Control	Selects whether the traffic sign recognition is displayed on the driver information interface.	ON/OFF^{*1}	

*1: Default Setting

Setup Group	Customizable Features	Description	Selectable settings
Meter Setup	Language	Changes the displayed language.	ENGLISH^{*1}/GERMAN/ ITALIAN/FRENCH/SPANISH/ PORTUGUESE/DUTCH/ DANISH/SWEDISH/ NORWEGIAN/FINNISH/ RUSSIAN/POLISH/TURKISH
	Adjust Outside Temp. Display	Adjusts the temperature reading by a few degrees.	-3°C ~ ±0°C^{*1} ~ +3°C
	“Trip A” Reset Timing	Changes the setting of how to reset trip meter A, average fuel economy A, average speed A, and elapsed time A.	When Fully Refueled/When Ignition Is Turned Off/ Manual Reset^{*1}
	“Trip B” Reset Timing	Changes the setting of how to reset trip meter B, average fuel economy B, average speed B, and elapsed time B.	When Fully Refueled/When Ignition Is Turned Off/ Manual Reset^{*1}
	Alarm Volume Control	Changes the alarm volume, such as buzzers, warnings, turn signal sound, and so on.	Max/Mid^{*1}/Min
	Fuel Efficiency Backlight	Turns the ambient meter feature on and off.	ON/OFF^{*1}
	Auto Idle Stop Display	Selects whether the Auto Idle Stop guidance screens comes on.	ON/OFF^{*1}
	Reverse Position Alert Tone*	Causes the beeper to sound once when the change the gear position to [R] .	ON/OFF^{*1}
	Tachometer	Selects whether the tachometer is displayed on the driver information interface.	ON/OFF^{*1}

*1: Default Setting

* Not available on all models



Setup Group	Customizable Features	Description	Selectable settings
Lighting Setup	Interior Light Dimmer Duration	Changes the length of time the interior lights stay on after you close the doors.	60sec/30sec^{*1}/15sec
	Headlight Auto Off Timer	Changes the length of time the exterior lights stay on after you close the driver's door.	60sec/30sec/15sec^{*1}/0sec
	Instrument Illumination Sensitivity	Changes the sensitivity of the brightness of the instrument panel when the headlight switch is in the AUTO position.	Max/High/Mid^{*1}/Low/Min
	Headlight Integration With Wipers	Changes the settings for the wiper operation when the headlights automatically come on while the headlight switch is in the AUTO position.	ON^{*1}/OFF
Door Setup	Key And Remote Unlock Mode	Sets up either the driver's door or all doors to unlock on the first operation of the remote or ignition key.	Driver Door Only^{*1}/All Doors
	Keyless Lock Notification	LOCK/UNLOCK- The exterior lights flash. LOCK (2nd push)- The beeper sounds.	ON^{*1}/OFF
	Security Relock Timer	Changes the time it takes for the doors to relock and the security system to set after you unlock the vehicle without opening any door.	90sec/60sec/30sec^{*1}
Maintenance Info.	—		Cancel/Reset
Default All	—		Cancel/OK

*1: Default Setting

■ Example of customization settings

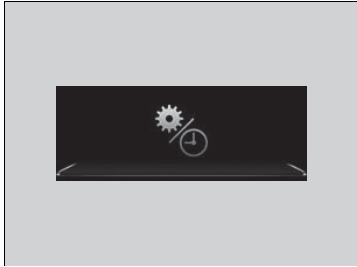
The steps for changing the “Trip A” Reset Timing setting to **When Fully Refueled** are shown below. The default setting for “Trip A” Reset Timing is **Manual Reset**.





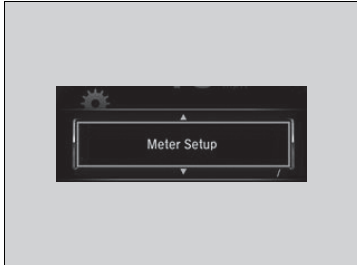

1. Press the  button to select , then press the **ENTER** button.



2. Press the  button until **Meter Setup** appears on the display.
3. Press the **ENTER** button.
 - ▶ **Language** appears first in the display.



4. Press the  button until **"Trip A" Reset Timing** appears on the display, then press the **ENTER** button.
 - ▶ The display switches to the customization setup screen, where you can select **When Fully Refueled**, **When Ignition Is Turned Off**, **Manual Reset**, or  (exit).
5. Press the  button and select **When Fully Refueled**, then press the **ENTER** button.
 - ▶ The **When Fully Refueled Setup** screen appears, then the display returns to the customization menu screen.
6. Press the  button until  (exit) appears on the display, then press the **ENTER** button.
7. Repeat Step 6 until you return to the normal screen.

Controls

This chapter explains how to operate the various controls necessary for driving.



Clock	170
Locking and Unlocking the Doors	
Key Types and Functions	173
Low Keyless Remote Signal Strength*	175
Locking/Unlocking the Doors from the Outside	176
Locking/Unlocking the Doors from the Inside	184
Childproof Door Locks	185
Opening and Closing the Boot	186
Security System	
Immobilizer System	189
Security System Alarm	189
Opening and Closing the Windows	192

Opening and Closing the Sunroof*	196
Operating the Switches Around the Steering Wheel	
Ignition Switch*	197
ENGINE START/STOP Button*	198
Ignition Switch and Power Mode Comparison	201
Turn Signals	202
Light Switches	202
Fog Lights*	206
Auto High-Beam (High Beam Support System)*	208
Headlight Adjuster*	211
Daytime Running Lights	212
Wipers and Washers	213

Brightness Control	216
Rear Demister/Heated Door Mirror* Button	218
Adjusting the Steering Wheel	219
Adjusting the Mirrors	
Interior Rearview Mirror	220
Power Door Mirrors	221
Adjusting the Seats	222
Interior Lights/Interior Convenience Items	
Interior Lights	231
Interior Convenience Items	233
Climate Control System	
Using Automatic Climate Control	244
Automatic Climate Control Sensors	250

* Not available on all models

Adjusting the Clock

Models without navigation system





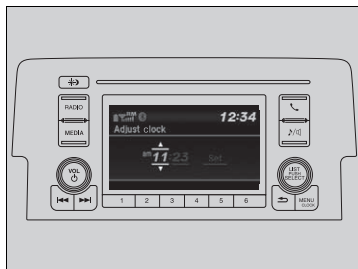

You can adjust the time in the clock display with the ignition switch in ON *1.

Adjusting the Time



Models with colour audio system

Using the MENU/CLOCK button

1. Press and hold the **MENU/CLOCK** button.
▶ **Adjust clock** is selected.
2. Rotate  to change hour, then press .
3. Rotate  to change minute, then press .
4. To enter the selection, rotate  and select **Set**, then press .

Adjusting the Clock

Models with Display Audio

The clock is automatically updated through the audio system, so the time does not need to be adjusted.

You can customize the clock display to show the 12 hour clock or 24 hour clock.

▶ **Customized Features** P. 359

Models with Display Audio

Models with colour audio system with driver information interface

You cannot adjust the time while the vehicle is moving.

Using the MENU/CLOCK button

Models with colour audio system

These indications are used to show how to operate the Selector Knob.

Rotate  to select.

Press  to enter.

*1: Models with the keyless access system have an **ENGINE START/STOP** button instead of an ignition switch.

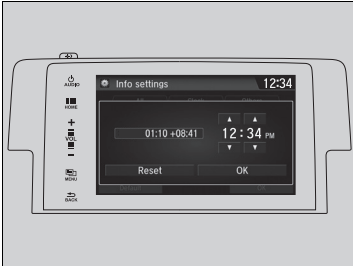

Models with Display Audio

■ Using the Settings menu on the audio/information screen

1. Select **Settings**.
2. Select **Clock**.
3. Select **Clock Adjustment**.
4. Select ▲ or ▼ to change hour.
5. Select ▲ or ▼ to change minute, then select **OK**.

▶▶ Using the Settings menu on the audio/information screen

Models with Display Audio

You can customize the clock display to show the 12 hour clock or 24 hour clock.

▶ **Customized Features** P. 359

You can customize the clock display.

▶ **Customized Features** P. 359

The clock is automatically updated when your smartphone is connected to the audio system.



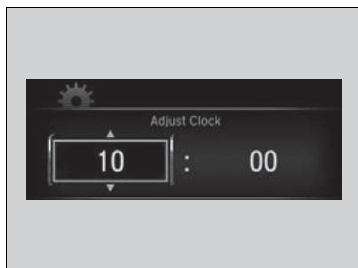

You can also adjust the clock by touching the clock displayed on the upper right corner of the display.

1. Touch the clock on the display for a few seconds.
2. Select **Clock Adjustment**.
3. Select ▲ or ▼ to change hour.
4. Select ▲ or ▼ to change minute, then select **OK**.



Models without audio system

■ Using the settings menu on the driver information interface

1. Press the  button to select , then press the **ENTER** button.
2. Press the  button until **Clock Setup** appears on the display.
3. Press the **ENTER** button.
4. Press the **ENTER** button to select **Adjust Clock**.
5. Press the  button to change hour, then press the **ENTER** button.
6. Press the  button to change minute, then press the **ENTER** button.
 - ▶ The display will return to the normal screen.

Key Types and Functions

This vehicle comes with the following keys:

Keys

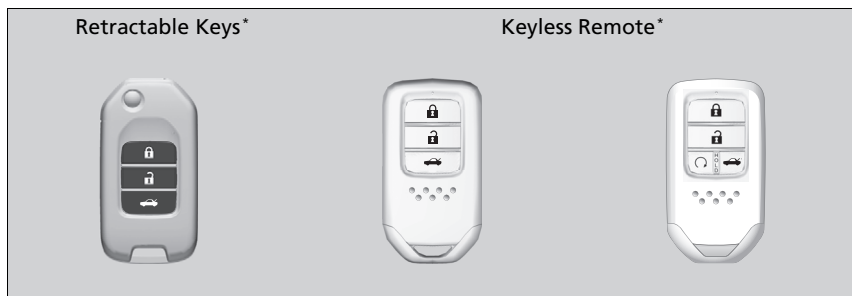

Use the key to start and stop the engine, and to lock and unlock all the doors. You can also use the remote transmitter to lock and unlock the doors and to open the boot.

Keyless remote*

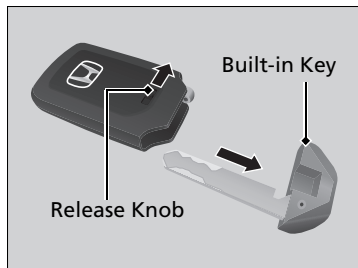

The built-in key can be used to lock/unlock the doors when the keyless remote battery becomes weak and the power door lock/unlock operation is disabled. To remove the built-in key, slide the release knob and then pull out the key. To reinstall the built-in key, push the built-in key into the keyless remote until it clicks.

* Not available on all models

Continued

Key Types and Functions

All the keys have an immobilizer system. The immobilizer system helps to protect against vehicle theft.

Immobilizer System P. 189

Follow the advice below to prevent damage to the keys:

- Do not leave the keys in direct sunlight, or in locations with high temperature or high humidity.
- Do not drop the keys or set heavy objects on them.
- Keep the keys away from liquids, dust and sand.
- Do not take the keys apart except for replacing the battery.

If the circuits in the keys are damaged, the engine may not start, and the remote transmitter may not work.

If the keys do not work properly, have them inspected by a dealer.

Models with remote engine starter

You can remotely start the engine using the remote engine start.

Remote Engine Start with Vehicle Feedback* P. 463

■ Retractable keys*

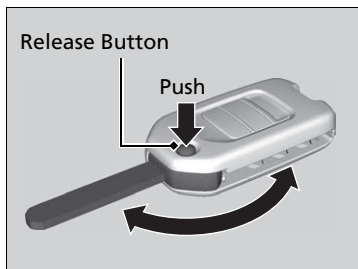

The key folds up inside the remote transmitter.

1. Press the release button to release the key out from the transmitter.
 - ▶ Make sure to fully extend the key.
2. To close the key, press the release button then push the key inside the transmitter until you hear a click.

■ Key Number Tag

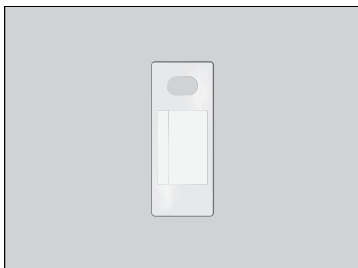

Contains a number that you will need if you purchase a replacement key.

▣ Retractable keys*

If the key is not fully extended, the immobilizer system may not work properly, and the engine may not start.

Avoid contact with the key whenever it extends or retracts.

▣ Key Number Tag

Keep the key number tag separate from the key in a safe place outside of your vehicle.

If you wish to purchase an additional key, contact a dealer.

If you lose your key and you cannot start the engine, contact a dealer.

Low Keyless Remote Signal Strength*

The vehicle transmits radio waves to locate the keyless remote when locking/unlocking the doors, opening the boot, or to start the engine.

In the following cases, locking/unlocking the doors or opening the boot or starting the engine may be inhibited or operation may be unstable:

- Strong radio waves are being transmitted by nearby equipment.
- You are carrying the keyless remote together with telecommunications equipment, laptop computers, mobile phones, or wireless devices.
- A metallic object is touching or covering the keyless remote.

Low Keyless Remote Signal Strength*

Communication between the keyless remote and the vehicle consumes the keyless remote's battery. The keyless remote battery lasts about two years. This changes by how often you use the remote. The battery is consumed whenever the keyless remote is receiving strong radio waves. Avoid placing it near electrical appliances such as televisions and personal computers.

* Not available on all models

Locking/Unlocking the Doors from the Outside

■ Using the Keyless Access System *

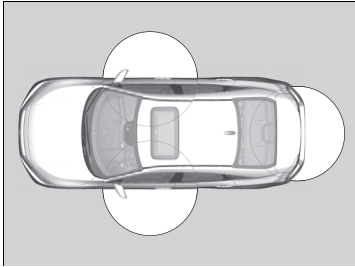

When you carry the keyless remote, you can lock/unlock the doors and open the boot. You can lock/unlock the doors within a radius of about 80 cm of the outside door handle. You can open the boot within about 80 cm radius from the boot release button.

■ Locking the vehicle

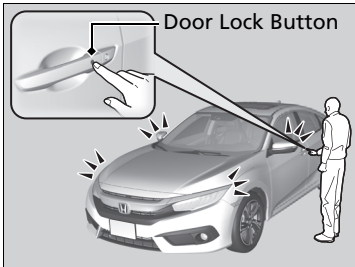

Models with 1.6 L engine and Turkish models

Press the door lock button on a front door.

- ▶ Some exterior lights flash: the beeper sounds: all the doors lock; and the security system sets.

Except models with 1.6 L engine and Turkish models

Press the door lock button on a front door.

- ▶ Some exterior lights flash three times; the beeper sounds; all the doors lock; and the security system sets.

▶▶ Locking/Unlocking the Doors from the Outside

If the interior light switch is in the door activated position, the interior lights come on when you press the unlock button.

No doors opened: The lights fade out after 30 seconds.

Doors relocked with the remote: The lights go off immediately.

▶ **Interior Lights** P. 231

▶▶ Using the Keyless Access System *

If you do not open a door within 30 seconds of unlocking the vehicle with the remote transmitter, the doors will automatically relock.

You can change the relock timer setting.

▶ **Customized Features** P. 359

You can lock or unlock doors using the keyless access system only when the power mode is in VEHICLE OFF (LOCK).

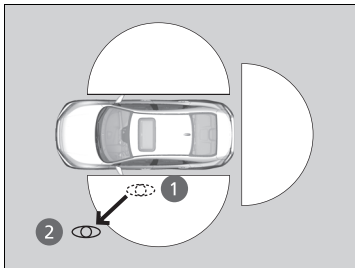
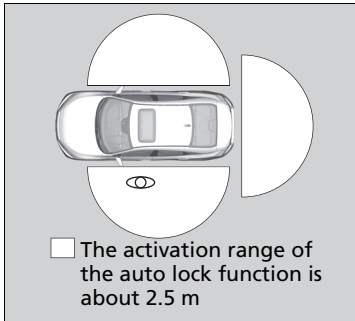

■ Locking the vehicle (Walk away auto lock*)

When you walk away from the vehicle while carrying the keyless remote, the doors will automatically lock.

The auto lock function activates when all doors are closed, and the keyless remote is within about 2.5 m radius of the outside door handle.

Exit vehicle while carrying keyless remote and close door(s).

1. While within about 2.5 m radius of the vehicle.

▶ The beeper sounds; the auto lock function will be activated.

2. Carry the keyless remote beyond about 1.5 m from the vehicle and remain outside this range for 2 or more seconds.

▶ Some exterior lights flash; the beeper sounds; all doors will then lock.

▣ Locking the vehicle (Walk away auto lock*)

The auto lock function is set to OFF as the factory default setting. The auto lock function can be set to ON using the audio/information screen.

If you set the auto lock function to ON using the audio/information screen, only the remote transmitter that was used to unlock the driver's door prior to the setting change can activate auto lock.

▶ Customized Features P. 359

After the auto lock function has been activated, when you stay within the locking/unlocking operation range, the indicator on the keyless remote will continue to flash until the doors are locked.

When you stay beside the vehicle within the operation range, the doors will automatically lock approximately 30 seconds after the auto lock function activating beeper sounds.

When you open a door after the auto lock function activating beeper sounds, the auto lock function will be cancelled.

When all doors have been closed and the keyless remote is inside the vehicle, or if the keyless remote is not detected within about 2.5 m of the vehicle, auto lock function will not be activated.

* Not available on all models

To temporarily deactivate the function:

1. Set the power mode to OFF.
2. Open the driver's door.
3. Using the master door lock switch, operate the lock as follows:
Lock → Unlock → Lock → Unlock.
▶ The beeper sounds and the function is deactivated.

To restore the function:

- Set the power mode to ON.
- Lock the vehicle without using the auto lock function
- With the keyless remote on you, move out of the auto lock function operation range.
- Open any door.

🔒 Locking the vehicle (Walk away auto lock*)

The auto lock function does not operate when any of the following conditions are met.

- The keyless remote is inside the vehicle.
- A door or the bonnet is not closed.
- The power mode is set to any mode other than OFF.
- The keyless remote is not located within a radius of about 2.5 m from the vehicle when you get out of the vehicle and close the doors.

Auto lock function operation stop beeper

After the auto lock function has been activated, the auto lock operation stop beeper sounds for approximately two seconds in the following cases.

- The keyless remote is put inside the vehicle through a window.
 - You are located too close to the vehicle.
 - The keyless remote is put inside the boot.
- If the warning beeper sounds, check that you are carrying the keyless remote. Then, open/close a door and confirm the auto lock activation beeper sounds once.

■ Unlocking the vehicle

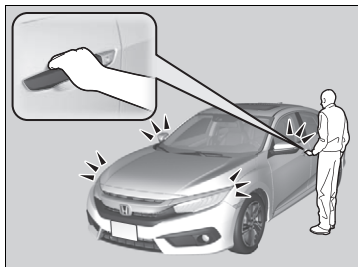

Models with 1.6 L engine and Turkish models

Grab the driver's door handle:

- ▶ All doors, fuel fill door unlock.
- ▶ Some exterior lights flash twice and the beeper sounds.

Except models with 1.6 L engine and Turkish models

Grab the driver's door handle:

- ▶ The driver's door and fuel fill door unlocks.
- ▶ Some exterior lights and indicators flash once and the beeper sounds.

Grab the front passenger's door handle:

- ▶ All the doors unlock.
- ▶ Some exterior lights and indicators flash once and the beeper sounds.

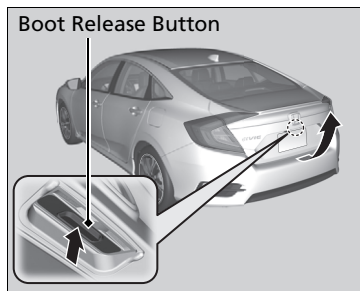

Models with 1.6 L engine and Turkish models

Press the boot release button:

- ▶ The boot unlocks and opens.
- ▶ Some exterior lights flash twice and the beeper sounds.

Except models with 1.6 L engine and Turkish models

Press the boot release button:

- ▶ The boot unlocks and opens.
- ▶ Some exterior lights flash once and the beeper sounds.

➤ **Using the Boot Release Button** P. 186

⊠ Using the Keyless Access System*

- Do not leave the keyless remote in the vehicle when you get out. Carry it with you.
- Even if you are not carrying the keyless remote, you can lock/unlock the doors while someone else with the remote is within range.
- The door may be unlocked if the door handle is covered with water in heavy rain or in a car wash if the keyless remote is within range.
- If you grip a front door handle wearing gloves, the door sensor may be slow to respond or may not respond by unlocking the doors.
- After locking the door, you have up to 2 seconds during which you can pull the door handle to confirm whether the door is locked. If you need to unlock the door immediately after locking it, wait at least 2 seconds before gripping the handle, otherwise the door will not unlock.
- The door may not open if you pull it immediately after gripping the door handle. Grip the handle again and confirm that the door is unlocked before pulling the handle.
- Even within the 80 cm radius, you may not be able to lock/unlock the doors with the keyless remote if it is above or below the outside handle.
- The keyless remote may not operate if it is too close to the door and door glass.

If you do not open a door within 30 seconds of unlocking the vehicle, the doors will automatically relock.

The light flash, beep, and unlock settings can be customized.

➤ **Customized Features** P. 359

* Not available on all models

■ Using the Remote Transmitter

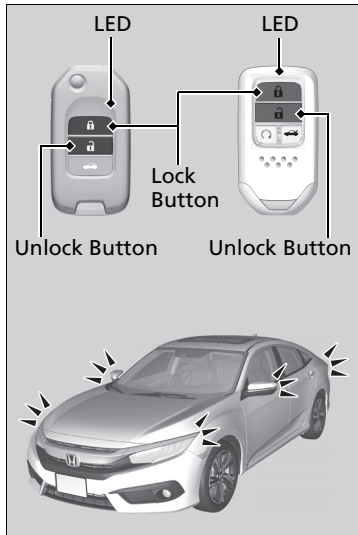

■ Locking the doors

Models with 1.6 L engine and Turkish models

Press the lock button.

- ▶ Some exterior lights flash, all the doors, and fuel fill door lock, and the security system sets.

Except models with 1.6 L engine and Turkish models

Press the lock button.

- ▶ Some exterior lights flash three times, all the doors, and fuel fill door lock, and the security system sets.

▶▶ Using the Remote Transmitter

Models without keyless access system

The remote transmitter uses low-power signals, so the operating range may vary depending on the surroundings.

Models with keyless access system

You can lock or unlock doors using the remote transmitter or keyless access system only when the power mode is in VEHICLE OFF (LOCK).

All models

The remote will not lock the vehicle when a door is open.

■ Unlocking the doors

Models with 1.6 L engine and Turkish models

Press the unlock button.

- ▶ Some exterior lights flash twice, and all doors, and fuel fill door unlock.

Except models with 1.6 L engine and Turkish models

Press the unlock button.

Once:

- ▶ Some exterior lights flash once, and the driver's door and fuel fill door unlocks.

Twice:

- ▶ The remaining doors and unlock.

☒ Using the Remote Transmitter

If the distance at which the remote transmitter works varies, the battery is probably low.

If the LED does not come on when you press a button, the battery is dead.

- ☒ **Replacing the Button Battery** P. 661

You can customize the door unlock mode setting.

- ☒ **Customized Features** P. 359

■ Locking/Unlocking the Doors Using a Key

If the keyless remote battery or the vehicle battery is dead, use the key instead of the keyless remote.

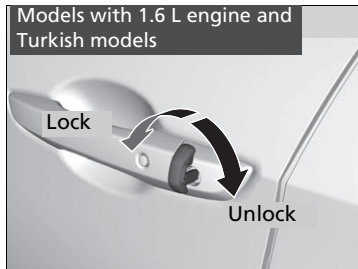

Fully insert the key and turn it.

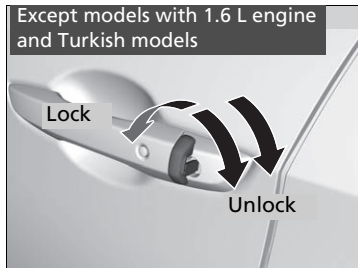

▶▶ Locking/Unlocking the Doors Using a Key

▶▶ Models with driver information interface

You can customize the door unlock mode setting.

▶▶ **Customized Features** P. 359

▶▶ Models with 1.6 L engine and Turkish models

When you lock/unlock the driver's door with a key, all the other doors lock/unlock at the same time.

▶▶ Except models with 1.6 L engine and Turkish models

When you lock the driver's door with the key, all the other doors lock at the same time.

When unlocking, the driver's door unlocks first. Turning the key a second time within a few seconds does not unlock the remaining doors and the tailgate.

▶▶ Israeli, Turkish, and except Middle Eastern models

Unlocking the doors with the key causes the security system to alarm. Always unlock the doors with the remote transmitter.

■ Locking a Door Without Using a Key

If you do not have the remote key on you, or if the battery of the remote key is dead, you can lock the doors without a key.

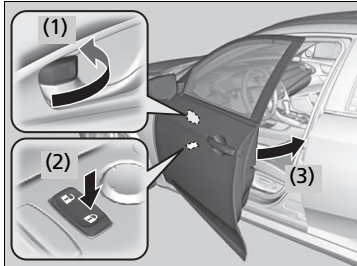

■ Locking the driver's door

Push the lock tab forward (1) or push the master door lock switch in the lock direction (2), then pull and hold the outside door handle (3). Close the door, then release the handle.

- ▶ The doors cannot be locked when the key is in the ignition switch*, or the keyless remote* is inside the vehicle.

■ Locking the passenger's doors

Push the lock tab forward and close the door.

■ Lockout prevention system

Ignition keys with remote transmitter

The doors cannot be locked when the key is in the ignition switch, and any door is open.

Models with keyless remote

The doors cannot be locked when the keyless remote is inside the vehicle.

⊠ Locking a Door Without Using a Key

When you lock the driver's door, all the other doors lock at the same time.

Before locking a door, make sure that the key is not inside the vehicle.

* Not available on all models

Locking/Unlocking the Doors from the Inside

■ Using the Lock Tab

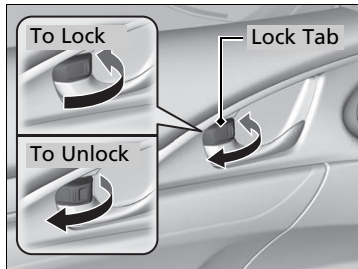

■ **Locking a door**
Push the lock tab forward.

■ **Unlocking a door**
Pull the lock tab rearward.

■ Unlocking Using the Front Door Inner Handle

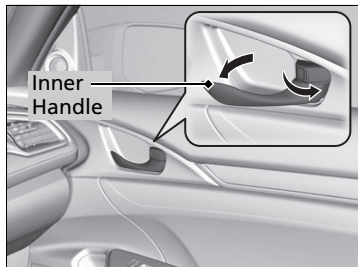

Pull the front door inner handle.
▶ The door unlocks and opens in one motion.

☒ Using the Lock Tab

When you lock/unlock the door using the lock tab on the driver's door, all the other doors lock/unlock at the same time.

☒ Unlocking Using the Front Door Inner Handle

The front door inner handles are designed to allow front seat occupants to open the door in one motion. However, this feature requires that front seat occupants never pull a front door inner handle while the vehicle is in motion.

Children should always ride in a rear seat where childproof door locks are provided.

☒ **Childproof Door Locks** P. 185

Using the Master Door Lock Switch*

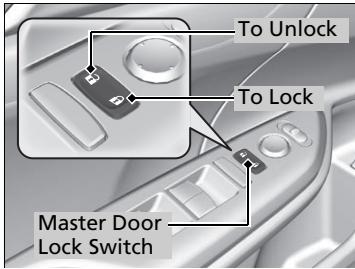

Press the master door lock switch in as shown to lock or unlock all doors.

⌘ Using the Master Door Lock Switch*

When you lock/unlock the front door using the master door lock switch, all the other doors lock/unlock at the same time.

Childproof Door Locks

The childproof door locks prevent the rear doors from being opened from the inside regardless of the position of the lock tab.

⌘ Childproof Door Locks

To open the door from the inside when the childproof door lock is on, put the lock tab in the unlock position, lower the rear window, put your hand out of the window, and pull the outside door handle.

Setting the Childproof Door Locks

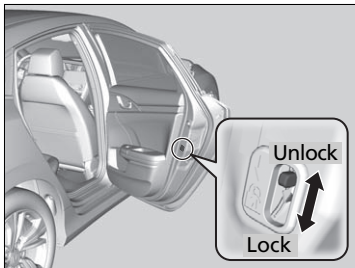

Slide the lever in the rear door to the lock position, and close the door.

When opening the door

Open the door using the outside door handle.

* Not available on all models

Precautions for Opening/Closing the Boot

■ Opening the boot

Open the boot all the way.

- ▶ If it is not fully opened, the boot lid may begin to close under its own weight.

■ Closing the boot

Keep the boot lid closed while driving to:

- ▶ Avoid possible damage.
- ▶ Prevent exhaust gas from leaking into the vehicle.
- **Carbon Monoxide Gas** P. 90

Using the Boot Release Button

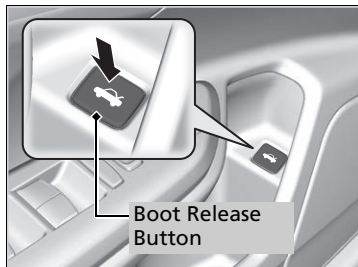

Pressing the boot release button on the driver's door.

- **When You Cannot Open the Boot** P. 720

Using the Remote Transmitter*

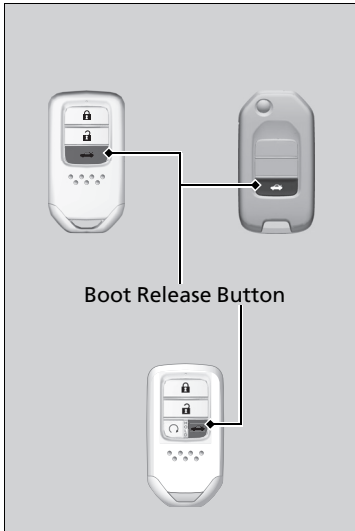

Press the boot release button for approximately one second to unlock and open the boot.

Using the Remote Transmitter*

Models with keyless access system

If the driver's door is locked, the boot will automatically lock when you close it. Otherwise, you will have to lock it manually.

* Not available on all models

Using the Boot Release*

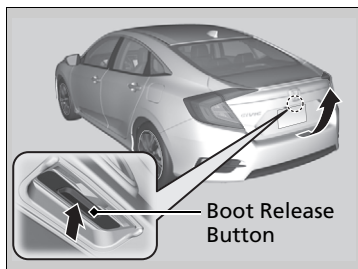

Push up the release button on the boot lid after the doors are unlocked.

Even if the boot is locked, you can open the boot if you are carrying the keyless remote.

- ▶ Some exterior lights flash and the beeper sounds.

⌘ Using the Boot Release*

- If you forget the remote inside, the beeper will sound and the boot will not close.
- A person who is not carrying the keyless remote can unlock the boot if a person who is carrying it is within range.
- If the beeper sounds after you close the boot, move the keyless remote away from the boot and close again.
- The keyless remote may not operate if it is too close to the rear boot.

Immobilizer System

The immobilizer system prevents a key that has not been pre-registered from starting the engine. Each key contains electronic transmitters that use electronic signals to verify the key.

Pay attention to the following when inserting the key into the ignition switch or selecting the **ENGINE START/STOP** button*:

- Do not allow objects that emit strong radio waves near the ignition switch or the **ENGINE START/STOP** button*.
- Make sure the key is not covered by or touching a metal object.
- Do not bring a key from another vehicle's immobilizer system near the ignition switch* or the **ENGINE START/STOP** button*.
- Do not put the key near magnetic items. Electronic devices such as televisions and audio systems emit strong magnetic fields. Note that even a key chain can become magnetic.

Security System Alarm

Israeli, Turkish, and except Middle Eastern models

The security system alarm activates when the boot, bonnet, or doors are opened without the remote transmitter, or keyless access system.

Middle Eastern except Israeli and Turkish models

The security system alarm activates when the boot, bonnet, or doors are opened without the key, remote transmitter, or keyless access system.

■ When the security system alarm activates

The horn sounds intermittently, and the some exterior lights flash.

* Not available on all models

Continued

Immobilizer System

NOTICE

Leaving the key in the vehicle can result in theft or accidental movement of the vehicle. Always take the key with you whenever you leave the vehicle unattended.

If the system repeatedly does not recognized the coding of your key, contact your dealer. If you have lost your key and cannot start your engine, contact a dealer.

Do not alter the system or add other devices to it. Doing so may damage the system and make your vehicle inoperable.

Security System Alarm

Do not alter the system or add other devices to it. Doing so may damage the system and make your vehicle inoperable.

The security alarm will continue for approximately 5 minutes before the security system deactivates.

The system will go through ten 30-second cycles, during which the beeper will sound and an emergency indicator will flash.

Depending on circumstances, the security system may continue operating for more than 5 minutes.

■ To deactivate the security system alarm

Israeli, Turkish, and except Middle Eastern models

Unlock the vehicle using the remote transmitter, keyless access system*, or turning the ignition switch to ON **II***¹. The system, along with the horn and flashing lights, is deactivated.

Middle Eastern except Israeli and Turkish models

Unlock the vehicle using the key, remote transmitter, keyless access system*, or turning the ignition switch to ON **II***¹. The system, along with the horn and flashing lights, is deactivated.

■ Setting the security system alarm

Models without keyless access system

The security system alarm automatically sets when the following conditions have been met:

- The ignition switch is in LOCK **0**, and the key has been removed from the ignition switch.
- The bonnet is closed.
- All doors are locked with the key or remote transmitter.

Models with keyless access system

The security system alarm automatically sets when the following conditions have been met:

- The power mode is set to VEHICLE OFF (LOCK).
- The bonnet is closed.
- All doors are locked from outside with the key, remote transmitter, or keyless access system.

*1: Models with the keyless access system have an **ENGINE START/STOP** button instead of an ignition switch.

* Not available on all models

►► Security System Alarm

Do not set the security system alarm when someone is in the vehicle or a window is open. The system can accidentally activate when:

- Unlocking the door with the lock tab.
- Opening the boot with the boot release button.

Israeli, Turkish, and except Middle Eastern models

If the 12-volt battery goes dead after you have set the security system alarm, the security alarm may go off once the 12-volt battery is recharged or replaced.

If this occurs, deactivate the security system alarm by unlocking a door using the remote transmitter or keyless access system*.

Middle Eastern except Israeli and Turkish models

If the 12-volt battery goes dead after you have set the security system alarm, the security alarm may go off once the 12-volt battery is recharged or replaced.

If this occurs, deactivate the security system alarm by unlocking a door using the key, remote transmitter or keyless access system*.

Do not attempt to alter this system or add another device to it.

Israeli, Turkish, and except Middle Eastern models

Do not unlock the door using the key. The security system alarm goes off.

■ When the security system alarm sets

The security system alarm indicator in the instrument panel blinks. When the blinking interval changes after about 15 seconds, the security system alarm is set.

■ To cancel the security system alarm

Models without keyless access system

The security system alarm is cancelled when the vehicle is unlocked using the key*¹ and remote transmitter, or the ignition switch is turned to ON. The security system alarm indicator goes off at the same time.

Models with keyless access system

The security system alarm is cancelled when the vehicle is unlocked using the key*¹, remote transmitter, or keyless access system, or the power mode is set to ON. The security system alarm indicator goes off at the same time.

*1: Middle Eastern except Israeli and Turkish models

Opening/Closing the Power Windows

The power windows can be opened and closed when the ignition switch is in ON **II***1, using the switches on the doors. The driver's side switches can be used to open and close all the windows.

The power window lock button on the driver's side must be switched off (not pushed in, indicator off) to open and close the windows from anywhere other than the driver's seat.

When the power window lock button is pushed in, you can only operate the driver's window. Turn the power window lock button on if a child is in the vehicle.

Opening/Closing Windows with Auto-Open/Close Function

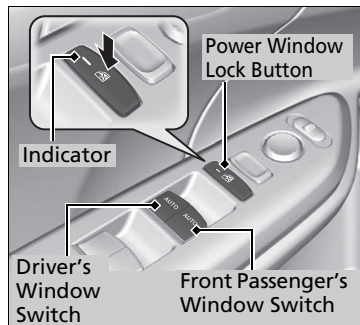

Automatic operation

To open: Push the switch down firmly.

To close: Pull the switch up firmly.

The window opens or closes completely. To stop the window at any time, push or pull the switch briefly.

Manual operation

To open: Push the switch down lightly, and hold it until the desired position is reached.

To close: Pull the switch up lightly, and hold it until the desired position is reached.

Opening/Closing the Power Windows

WARNING

Closing a power window on someone's hands or fingers can cause serious injury.

Make sure your passengers are away from the windows before closing them.

WARNING: Always take the ignition key with you whenever you leave the vehicle alone (with other occupants).

The power windows can be operated for up to 10 minutes after you turn the ignition switch to LOCK **0***1. Opening either front door cancels this function.

Auto Reverse

If a power window senses resistance when closing automatically, it stops closing and reverse direction.

The driver's window auto reverse function is disabled when you continuously pull up the switch.

The auto reverse function stops sensing when the window is almost closed to ensure that it fully closes.

*1: Models with the keyless access system have an **ENGINE START/STOP** button instead of an ignition switch.

■ Opening/Closing Windows without Auto-Open/Close Function

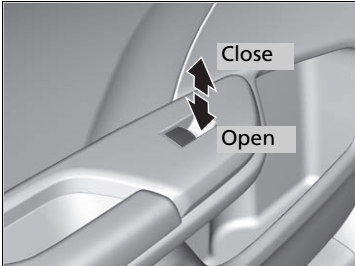

To open: Push the switch down.

To close: Pull the switch up.

Release the switch when the window reaches the desired position.

■ Opening Windows and Sunroof* with the Remote

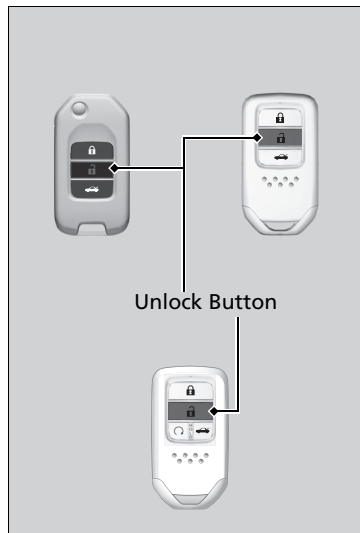

To open: Press the unlock button, and then within 10 seconds, press it again and keep it pressed.

To close*: Press the lock button, and then within 10 seconds, press it again and keep it pressed.

If the windows stop midway, repeat the procedure.

■ Opening/Closing the Windows and Sunroof* with the Key

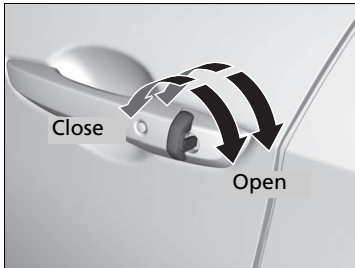

To open*: Unlock the driver's door with the key. Within 10 seconds of returning the key to the central position, turn the key in the unlock direction and hold it there.

To close: Lock the driver's door with the key. Within 10 seconds of returning the key to the central position, turn the key in the lock direction and hold it there.

Release the key to stop the windows and sunroof at the desired position. If you want further adjustment, repeat the same operation.

* Not available on all models

■ Opening/Closing the Sunroof

You can operate the sunroof only when the ignition switch is in ON **II***¹. Use the switch in the front of the ceiling to open and close the sunroof.

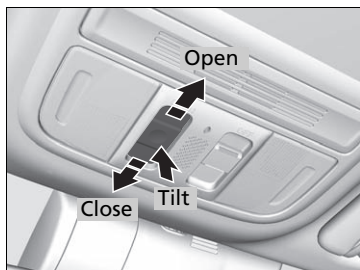

■ Automatic operation

To open: Pull the switch back firmly.

To close: Push the switch forward firmly.

The sunroof automatically opens or closes all the way. To stop the sunroof midway, push the switch briefly.

■ Manual operation

To open: Pull the switch back lightly, and hold it until the desired position is reached.

To close: Push the switch forward lightly, and hold it until the desired position is reached.

■ Tilting the sunroof up

To tilt: Push on the centre of the sunroof switch.

To close: Push the switch forward firmly, then release.

*1: Models with the keyless access system have an **ENGINE START/STOP** button instead of an ignition switch.

* Not available on all models

☞ Opening/Closing the Sunroof

⚠ WARNING

Opening or closing the sunroof on someone's hands or fingers can cause serious injury.

Make sure all hands and fingers are clear of the sunroof before opening or closing it.

WARNING: Always take the ignition key with you whenever you leave the vehicle alone (with other occupants).

NOTICE

Opening the sunroof in below freezing temperature or when it is covered with snow or ice can damage the sunroof panel or motor.

The power sunroof can be operated for up to 10 minutes after you turn the ignition switch off*¹. Opening either front door cancels this function.

When resistance is detected, the auto reverse function causes the sunroof to change directions, then stop. Auto reverse stops sensing when the sunroof is almost closed to ensure that it fully closes.

You can use the remote transmitter or the key to operate the sunroof.

☞ **Opening Windows and Sunroof* with the Remote** P. 194

☞ **Opening/Closing the Windows and Sunroof* with the Key** P. 195

Ignition Switch *

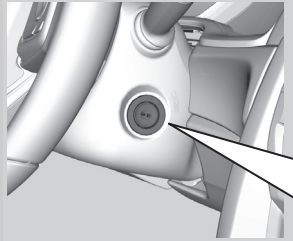

- 0** LOCK: Insert and remove the key in this position.
- I** ACCESSORY: Operate the audio system and other accessories in this position.
- II** ON: This is the position when driving.
- III** START: This position is for starting the engine. The switch returns to ON **II** when you let go of the key.

Ignition Switch *

Manual transmission models

⚠ WARNING

Removing the key from the ignition switch while driving locks the steering. This can cause you to lose control of the vehicle.

Remove the key from the ignition switch only when parked.



Continuously variable transmission models

You cannot take the key out unless the shift lever is in **P**.

All models

If you open the driver's door when the key is in LOCK **0** or ACCESSORY **I**, a warning buzzer will sound to remind you to take the key out.

When this happens, the following messages appear on the driver information interface*:

- In LOCK **0**:  or the symbol with a **Ignition Key**
- In ACCESSORY **I**:  or the symbol with a **Return IGN Switch To (0) Position**

The buzzer will stop when you take the key out.

If the key won't turn from LOCK **0** to ACCESSORY **I**, turn the key while moving the steering wheel left and right. The steering wheel will unlock, allowing the key to turn.

* Not available on all models

ENGINE START/STOP Button*

■ Changing the Power Mode

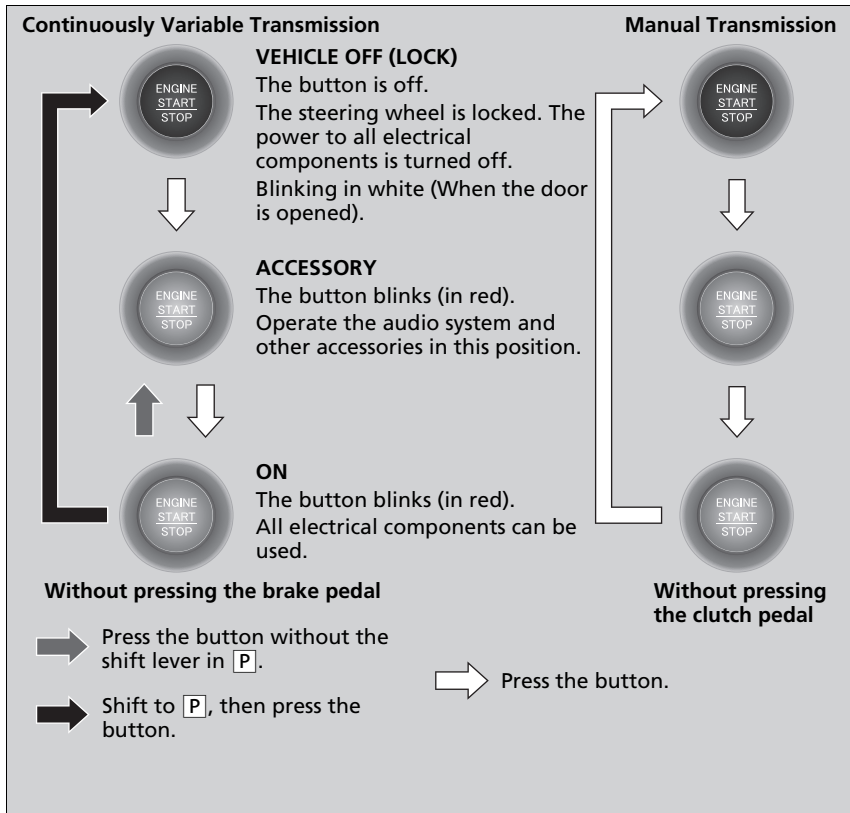

Controls

⊗ ENGINE START/STOP Button*

ENGINE START/STOP Button Operating Range

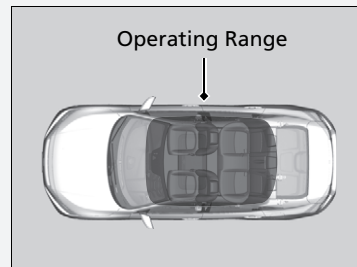

You can start the engine when the keyless remote is inside the vehicle. The engine may also run if the keyless remote is close to a door or window, even if it is outside the vehicle.

ON mode:

The **ENGINE START/STOP** button is red when the engine is running.

If the keyless remote battery is weak, the beeper sounds and the **To Start, Hold Remote Near Start Button** message appears on the driver information interface*.

⊗ **If the Keyless Remote Battery is Weak**
P. 693

■ Automatic Power Off

If you leave the vehicle for 30 to 60 minutes with the shift lever in **P** and the power mode in ACCESSORY, the vehicle automatically goes into the mode similar to VEHICLE OFF (LOCK) to avoid draining the battery.

When in this mode:

The steering wheel does not lock. You cannot lock or unlock doors with the remote transmitter or the keyless access system.

Press the **ENGINE START/STOP** button twice to switch the mode to VEHICLE OFF (LOCK).

■ Power Mode Reminder

If you open the driver's door when the power mode is set to ACCESSORY, a warning buzzer sounds.

■ Keyless Remote Reminder

Models with information display



Models with driver information interface

Middle Eastern except Israeli and Turkish models

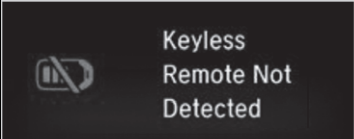

Israeli, Turkish, and except Middle Eastern models

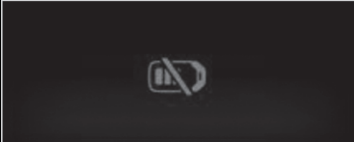

Warning buzzers may sound from inside or/ and outside the vehicle to remind you that the keyless remote is out of the vehicle. If the buzzer continues even after the remote is put back inside, place it to be within its operational range.

■ When the power mode is in ON

If the keyless remote is taken out of the vehicle, and the driver's door is closed, warning buzzer sounds from both inside and outside the vehicle. A warning message on the driver information interface notifies the driver inside that the remote is outside of the vehicle.

■ When the power mode is in ACCESSORY

If the keyless remote is taken out of the vehicle, and the driver's door is closed, a warning buzzer sounds from outside the vehicle.

⌘ Keyless Remote Reminder









When the keyless remote is within the system's operational range, and the driver's door is closed, the warning function cancels.

If the keyless remote is taken out of the vehicle after the engine has been started, you can no longer change the **ENGINE START/STOP** button mode or restart the engine. Always make sure if the remote is in your vehicle when you operate the **ENGINE START/STOP** button.

Removing the keyless remote from the vehicle through a window does not activate the warning buzzer.

Do not put the keyless remote on the dashboard or in the glove box. It may cause the warning buzzer to go off. Under some other conditions that can prevent the vehicle from locating the remote, the warning buzzer may also go off even if the remote is within the system's operational range.

Ignition Switch and Power Mode Comparison

Ignition Switch Position	LOCK (0) (with/without the key) 	ACCESSORY (I) 	ON (II) 	START (III) 
Without Keyless Access System	<ul style="list-style-type: none"> • Engine is turned off and power is shut down. • The steering wheel is locked. • No electrical components can be used. 	<ul style="list-style-type: none"> • Engine is turned off. • Some electrical components such as the audio system and the accessory power socket can be operated. 	<ul style="list-style-type: none"> • Normal key position while driving. • All electrical components can be used. 	<ul style="list-style-type: none"> • Use this position to start the engine. • The ignition switch returns to the ON (II) position when you release the key.
Power Mode	VEHICLE OFF (LOCK) 	ACCESSORY 	ON   Button is: Blinking On	START 
With Keyless Access System and ENGINE START/STOP Button	Button-Off <ul style="list-style-type: none"> • Engine is turned off and power is shut down. • The steering wheel is locked. • No electrical components can be used. 	Button-Blinking <ul style="list-style-type: none"> • Engine is turned off. • Some electrical components such as the audio system and the accessory power socket can be operated. 	Button-Blinking (engine is turned off) On (engine is running) <ul style="list-style-type: none"> • All electrical components can be used. 	Button-On <ul style="list-style-type: none"> • The mode automatically returns to ON after the engine starts.

Turn Signals

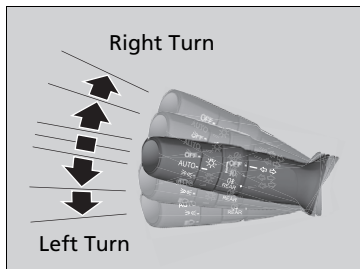

The turn signals can be used when the ignition switch is in ON **II***1.

■ One-touch turn signal

When you lightly push up or down and release the turn signal lever, the exterior turn signals and turn signal indicator blink three times. This feature can be used when signaling for a lane change.

Light Switches

■ Manual Operation

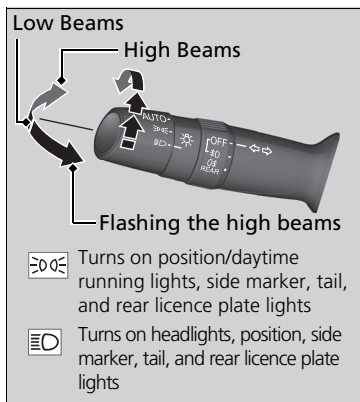

Rotating the light switch turns the lights on and off, regardless of the power mode setting or position of the ignition switch.

■ High beams

Push the lever forward until you hear a click.

■ Low beams

When in high beams, pull the lever back to return to low beams.

■ Flashing the high beams

Pull the lever back, and release it.

*1: Models with the keyless access system have an **ENGINE START/STOP** button instead of an ignition switch.

▶▶ Light Switches

■ Models with keyless access system

If you leave the power mode in VEHICLE OFF (LOCK) while the lights are on, a chime sounds when the driver's door is opened.

■ Models without keyless access system

If you remove the key from the ignition switch while the lights are on, a chime sounds when the driver's door is opened.

When the lights are on, the lights on indicator in the instrument panel will be on.

▶▶ Lights On Indicator P. 108

Do not leave the lights on when the engine is off because it will cause the battery to discharge.

■ Lights off

Turn the lever to OFF either when:

- The shift lever is in **P**. (Continuously Variable Transmission models)
- The parking brake is applied.

To turn the lights on again, turn the lever to OFF to cancel the lights off mode. Even if you do not cancel the lights off mode, the lights come on automatically when:

- The shift lever is moved out of **P**.
(Continuously Variable Transmission models)
- The parking brake is released.
- The vehicle starts to move.

■ Automatic Operation (automatic lighting control)*

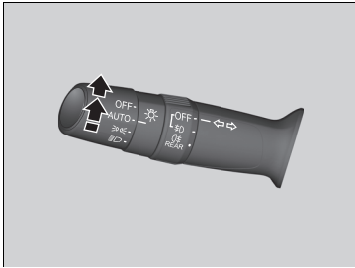

Automatic lighting control can be used when the ignition switch is in ON *1.

When you turn the light switch to **AUTO**, the headlights and other exterior lights will switch on and off automatically depending on the ambient brightness.

- ▶ You can change the auto light sensitivity setting.
 - ▶ **Customized Features** P. 359

*1: Models with the keyless access system have an **ENGINE START/STOP** button instead of an ignition switch.

▶▶ Automatic Operation (automatic lighting control)*

We recommend that you turn on the lights manually when driving at night, in a dense fog, or in dark areas such as long tunnels or parking facilities.

The light sensor is in the location shown below. Do not cover this light sensor with anything; otherwise, the automatic lighting system may not work properly.

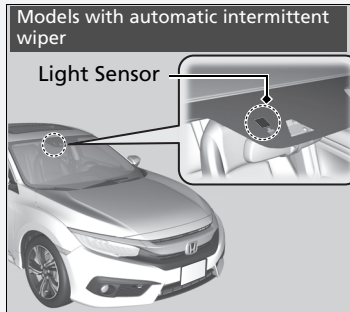
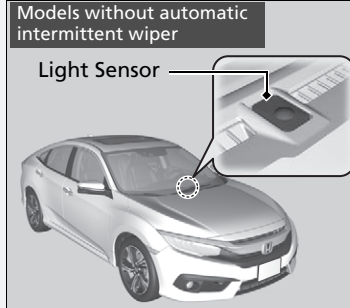

Headlight Integration with Wipers*

The headlights automatically come on when the wipers are used several times within a certain number of intervals with the headlight switch in **AUTO**.

The headlights automatically go off a few minutes later if the wipers are stopped.

Automatic Lighting Off Feature*

Models without keyless access system

The headlights, all other exterior lights, and the instrument panel lights turn off 15 seconds after you remove the key, and close the driver's door.

Models with keyless access system

The headlights, all other exterior lights, and the instrument panel lights turn off 15 seconds after you set the power mode to VEHICLE OFF (LOCK), take the remote with you, and close the driver's door.

If you turn the ignition switch to LOCK [0]*1 with the headlight switch on, but do not open the door, the lights turn off after 10 minutes (three minutes, if the switch is in the **AUTO** position).

The lights turn on again when you unlock or open the driver's door. If you unlock the door, but do not open it within 15 seconds, the lights go off. If you open the driver's door, you will hear a lights on reminder chime.

* 1: Models with the keyless access system have an **ENGINE START/STOP** button instead of an ignition switch.

* Not available on all models

Headlight Integration with Wipers*

This feature activates while the headlights are off in **AUTO**.

The instrument panel brightness does not change when the headlights come on.

At dark ambient light levels, the automatic lighting control feature turns on the headlights, regardless of the number of wiper sweeps.

Fog Lights*

■ Front fog lights

Can be used when the position lights or the headlights are on.



■ Rear fog light

Can be used when the headlights or the front fog lights are on.

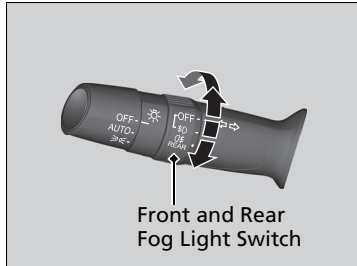

■ Front and Rear Fog Lights



■ To turn the front fog lights on

Rotate the switch up from the **OFF** position to the  position. The  indicator comes on.

■ To turn the front and rear fog lights on

Rotate the switch one position up from the  position. The  and  indicators come on.

■ To turn the rear fog light on

Rotate the switch down from the **OFF** position. The  indicator comes on.

■ Front Fog Lights

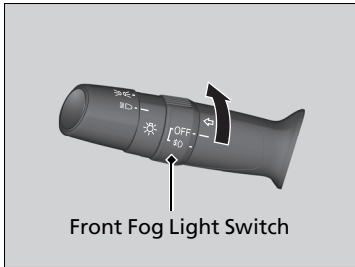

■ **To turn the front fog lights on**
Rotate the switch to ☼. The ☼ indicator comes on.

■ Rear Fog Light

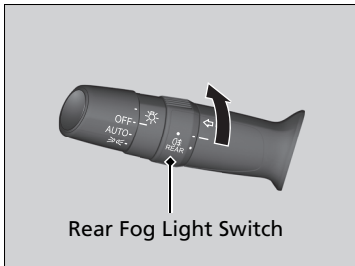

■ **To turn the rear fog light on**
Rotate the switch to ☼. The ☼ indicator comes on.

Auto High-Beam (High Beam Support System)*

Uses the camera attached to the windscreen, monitors the space ahead of your vehicle, and automatically changes the low beam headlights to high beam headlights when necessary.

The system operates when:

- The headlight switch is in **AUTO**.
- The lever is in the low beam position.
- The system recognizes that you are driving at night and the low beam headlights come on.
- The vehicle speed is above 40 km/h.

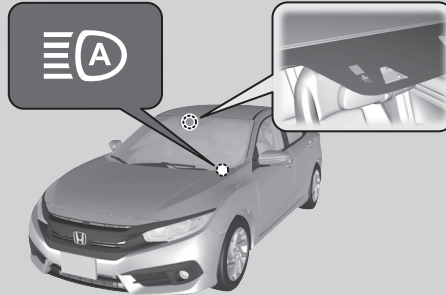

The system changes between high and low beam headlights when:

The camera is not detecting any lights coming from preceding or oncoming vehicles: The headlights change to high beams.

The camera detects lights coming from a preceding or oncoming vehicle: The headlights are returned to low beams.

The view angle or distance that the camera can detect lights ahead differs depending on conditions, such as the brightness of the lights and the weather.

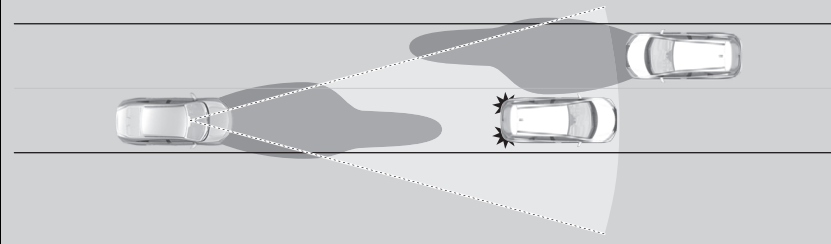

ⓘ Auto High-Beam (High Beam Support System)*

The auto high-beam may not work under certain conditions.

The system is for your convenience only. Always confirm the surroundings, and if necessary, change the headlight beams manually.

The auto high-beam determines when to change the headlight beams by responding to the brightness of the lights ahead of your vehicle. In the following cases, however, the system may not respond to the lights properly:

- The brightness of the lights from the preceding or oncoming vehicle is intense or poor.
- Visibility is poor due to the weather (rain, snow, fog, windscreen frost, etc.).
- Other light sources, such as streetlights and electric billboards are illuminating the road ahead.
- The brightness level of the road ahead constantly changes.
- The road is bumpy or has many curves.
- A vehicle ahead of you suddenly cuts you off or is not travelling in the appropriate direction.
- Your vehicle is tilted due to a heavy load in the rear.

If you find the timing of beam changes inconvenient for driving, change the headlight beams manually.

■ To Operate the System

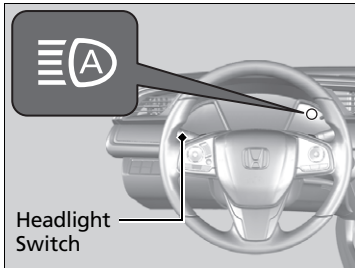

Turn the headlight switch in **AUTO** and pull the headlight lever to low beam.

☒ **Light Switches** P. 202

The auto high-beam indicator comes on.

■ Temporary cancellation

The auto high-beam operation is temporarily cancelled while:

- You are continuously driving at a speed below 24 km/h.
- The vehicle speed is below 10 km/h.
- The windscreen wipers run at high speed for more than a few seconds.

The system operation resumes once the condition that caused it to cancel improves.

☒ To Operate the System

For the auto high-beam to work properly:

- Do not place an object that reflects light on the dashboard.
- Keep the windscreen around the camera clean. When cleaning the windscreen, be careful not to apply the windscreen cleanser to the camera lens.
- Do not attach an object, sticker or film in the area around the camera.
- Do not touch the camera lens.

If the camera receives a strong impact, or repairing of the area near the camera is required, consult a dealer.

■ To manually cancel the system temporarily

You can cancel the operation when you manually change the headlights to high beams. Push the lever forward until you hear a click, or lightly pull the lever towards you to flash high beams. The auto high-beam indicator goes off.

If you want the auto high-beam operation to resume at once, pull and hold the lever towards you for a few seconds.

■ To Disable the System

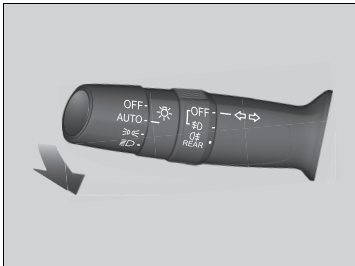

Disable the system when the vehicle is parked with the power mode in ON.

To disable the system: Press the auto button for about more than 40 seconds. The indicator blinks twice.

To enable the system: Press the auto button for about more than 30 seconds. The indicator blinks once.

▶▶ To Operate the System

If the  message appears:

- Park your vehicle in a safe place, and clean the windscreen. If the message does not disappear after you have cleaned the windscreen and driven for a while, have your vehicle checked by a dealer.

▶▶ To Disable the System

The auto high-beam is in the previously selected disabled or enabled setting each time you start the engine.

Headlight Adjuster*

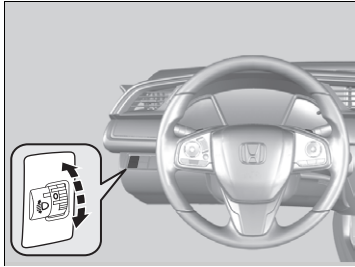

You can adjust the vertical angle of the low beam headlights when the ignition switch is in ON **II***1.

Turn the adjustment dial to select an appropriate angle for the headlights.

The larger dial number indicates the lower angle.

1. Push the dial to pop it out, then turn it to select a number.
2. Push it again after selecting.

■ To select the adjustment dial position

Refer to the below table for the appropriate dial position for your vehicle's riding and loading conditions.

Condition	Dial position
A driver	0
A driver and a front passenger	0
Five persons in the front and rear seats	1
Five persons in the front and rear seats and luggage in the boot, within the limits of maximum permissible axle weight and maximum permissible vehicle weight	2
A driver and luggage in the boot, within the limits of maximum permissible axle weight and maximum permissible vehicle weight	3

*1: Models with the keyless access system have an **ENGINE START/STOP** button instead of an ignition switch.

* Not available on all models

⊞ Headlight Adjuster*

Models with automatic headlight adjuster system

Your vehicle is equipped with the automatic headlight adjusting system that automatically adjusts the vertical angle of the low beam headlights. If you find a significant change in the vertical angle of the headlights, there may be a problem with the system. Have your vehicle checked by a dealer.

Models with halogen headlights

The headlights are suitable for left hand drive and right hand drive, without the need to make any adjustments or masking, as per UN Regulation No. 48 Dover Regulation.

The headlights are suitable for both right and left hand traffic. You do not need to alter the headlight beam distribution.

Models with LED headlight

You may need to alter the headlight beam distribution.

➤ **Adjusting Headlight Distribution** P. 559

Daytime Running Lights

Israeli, Turkish, and except Middle Eastern models

The daytime running lights come on when the following conditions have been met:

- The ignition switch is in ON **II***1.
- The headlight switch is **AUTO** and it is bright outside.

The daytime running lights turn off when the following conditions have been met:

- Turning off the ignition switch or setting the power mode to VEHICLE OFF will turn off the daytime running lights.
- The headlight switch is turned on or position, or when the headlight switch is in **AUTO** and it is getting darker outside.
- The vehicle is stopped, and the shift lever is in **P** and the headlight switch is in the **OFF** position.

The daytime running lights turn on again when the shift lever is out of **P** and the parking brake is released, or the light switch is moved from **AUTO** to **OFF**.

Middle Eastern except Israeli and Turkish models

When the following conditions have been met:

- The ignition switch is in ON **II***1.
- The headlight switch is **OFF**.

The daytime running lights turn off when the following conditions have been met:

- Turning off the ignition switch or setting the power mode to VEHICLE OFF will turn off the daytime running lights.
- The headlight switch is turned on or position.

*1: Models with the keyless access system have an **ENGINE START/STOP** button instead of an ignition switch.

» Daytime Running Lights

The daytime running lights come on dimmer when the headlight switch is in **OFF** than when it is in **AUTO**. In **AUTO**, if the ambient brightness is dark, the low beam headlights come on.

Wipers and Washers

Windscreen Wipers/Washers

Pull to use washer.

Intermittent Time Adjustment Ring*

- 1 MIST
- 2 OFF
- 3 INT*: Low speed with intermittent
AUTO*: Automatic intermittent operation
- 4 LO: Low speed wipe
- 5 HI: High speed wipe

The windscreen wipers and washers can be used when the ignition switch is in ON *1.

■ MIST

The wipers run at high speed until you release the lever.

■ Wiper switch (OFF, INT*, LO, HI)

Change the wiper switch setting according to the amount of rain.

■ AUTO*

Automatic Intermittent Wipers* P. 214

■ Adjusting wiper operation*

Turn the adjustment ring to adjust the wiper delay.

- Lower speed, fewer sweeps

+ Higher speed, more sweeps

■ Washer

Sprays while you pull the lever towards you. When you release the lever for more than one second, the spray stops, the wipers sweep two or three more times to clear the windscreen, then stop.

*1: Models with the keyless access system have an **ENGINE START/STOP** button instead of an ignition switch.

* Not available on all models

Continued

Wipers and Washers

NOTICE

Do not use the wipers when the windscreen is dry. The windscreen will get scratched, or the rubber blades will get damaged.

NOTICE

In cold weather, the blades may freeze to the windscreen. Operating the wipers in this condition may damage the wipers. Use the demister to warm the windscreen, then turn the wipers on.

Models with adjustment ring

If the vehicle speeds up while the wipers are operating intermittently, the length of the wipe interval shortens. When the vehicle starts moving, the wipers make a single sweep. When the vehicle speeds up, the wiper operation's shortest delay setting and the **LO** setting become the same.

All models

Turn the washers off if no washer fluid comes out. The pump may get damaged.

The wiper motor may stop motor operation temporarily to prevent an overload. Wiper operation will return to normal within a few minutes, once the circuit has returned to normal.

If the wiper stops operating due to an obstacle such as the build-up of snow, park the vehicle in a safe place.

Rotate the wiper switch to **OFF**, and turn the ignition switch to **ACCESSORY** 1 or **LOCK** *1, then remove the obstacle.

■ Automatic Intermittent Wipers*

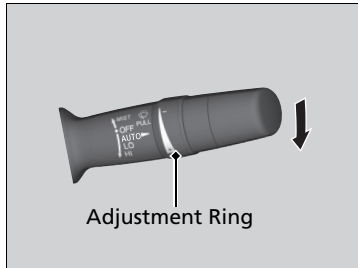

When you push the lever down to **AUTO**, the windshield wipers sweep once, and go into the automatic mode.

The wipers operate intermittently, at low speed, or at high speed and stops in accordance with the amount of rainfall the rainfall sensor detects.

■ AUTO sensitivity adjustment

When in **AUTO**, you can also adjust the rainfall sensor sensitivity using the intermittent time adjustment ring.

Sensor sensitivity

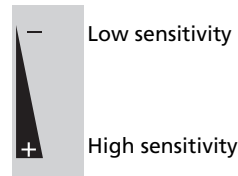

▶ Automatic Intermittent Wipers*

The rainfall sensor is in the location shown below.

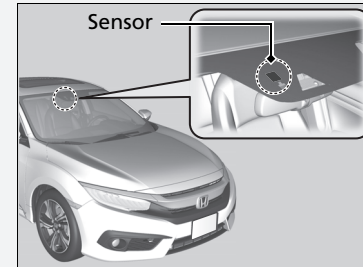

AUTO should always be turned **OFF** before the following situation in order to severe damage to the wiper system:

- Cleaning the windshield
- Driving through a car wash

Headlight Washers*

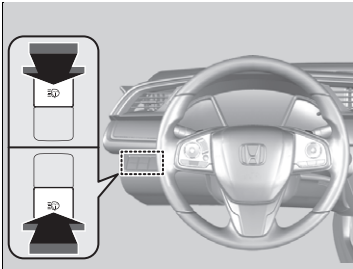

Turn the headlights on and press the headlight washers button to operate. The headlight washers also operate when you turn the windscreen washers for the first time after the ignition switch is turned to ON *1.

Headlight Washers*

The headlight washers use the same fluid reservoir as the windscreen washers.

*1: Models with the keyless access system have an **ENGINE START/STOP** button instead of an ignition switch.

* Not available on all models

Brightness Control

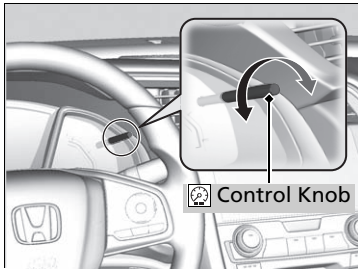

When the position lights are turned on and the ignition switch is in ON **II***¹, you can use the brightness control knob to adjust instrument panel brightness.

Brighten: Turn the knob to the right.

Dim: Turn the knob to the left.

You will hear a beeper* when the brightness reaches minimum or maximum. Several seconds after you have adjusted the brightness, you will be returned to the previous screen.

» Brightness Control

Instrument panel brightness varies, depending on whether the exterior lights are on or off. The instrument panel dims to reduce glare when they are on.

To cancel the reduced instrument panel brightness when the exterior lights are on, turn the knob to the right until the brightness display is up to max, the beeper* sounds.

The brightness can be set differently for when the exterior lights are on, and when they are off.

*1: Models with the keyless access system have an **ENGINE START/STOP** button instead of an ignition switch.

* Not available on all models

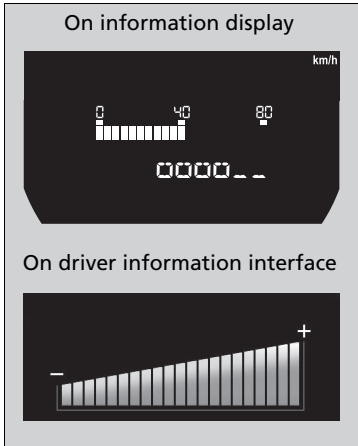

■ **Brightness level indicator**
The brightness level is shown on the display while you are adjusting it.

Rear Demister/Heated Door Mirror* Button

Press the rear demister and heated door mirror button to defog the rear window and mirrors when the ignition switch is in ON **II***1.

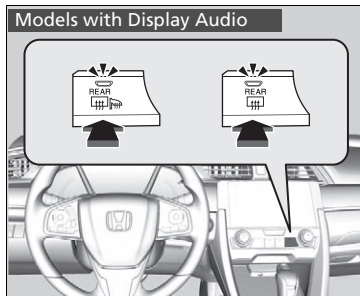
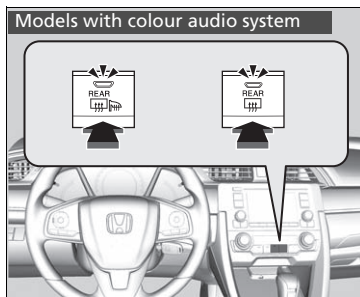

The rear demister and heated door mirrors automatically switch off after 10-30 minutes depending on the outside temperature. However, if the outside temperature is 0°C or below, they do not automatically switch off.

▶▶ Rear Demister/Heated Door Mirror* Button

NOTICE

When cleaning the inside of the rear window, be careful not to damage the heating wires. It is critical to wipe the window from side to side along the demister heating wires.

This system consumes a lot of power, and may weaken the battery, making it difficult to start the engine. Turn it off when the window has been defogged. Also, do not use the system for a long period even if the engine is idling.

*1: Models with the keyless access system have an **ENGINE START/STOP** button instead of an ignition switch.

* Not available on all models

Adjusting the Steering Wheel

The steering wheel height and distance from your body can be adjusted so that you can comfortably grip the steering wheel in an appropriate driving posture.

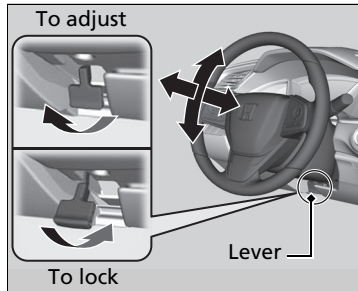

1. Pull the steering wheel adjustment lever up.
 - ▶ The steering wheel adjustment lever is under the steering column.
2. Move the steering wheel up or down, and in or out.
 - ▶ Make sure you can see the instrument panel gauges and indicators.
3. Push the steering wheel adjustment lever down to lock the steering wheel in position.
 - ▶ After adjusting the position, make sure you have securely locked the steering wheel in place by trying to move it up, down, in, and out.

Adjusting the Steering Wheel

⚠ WARNING

Adjusting the steering wheel position while driving may cause you to lose control of the vehicle and be seriously injured in a crash.

Adjust the steering wheel only when the vehicle is stopped.

Make any steering wheel adjustments before you start driving.

Interior Rearview Mirror

Adjust the angle of the rearview mirror when you are sitting in the correct driving position.

Rearview Mirror with Day and Night Positions*

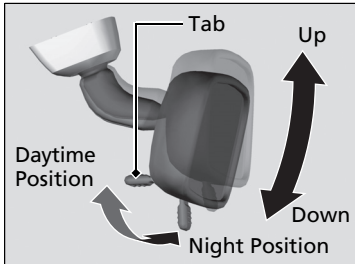

Flip the tab to switch the position. The night position helps to reduce the glare from headlights behind you when driving after dark.

Automatic Dimming Rearview Mirror*

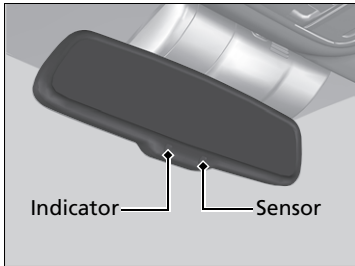

When you are driving after dark, the automatic dimming rearview mirror and power door reduces the glare from headlights behind you, based in inputs from the mirror sensor. This feature is always active.

Adjusting the Mirrors

Keep the inside and outside mirrors clean and adjusted for best visibility.

Adjust the mirrors before you start driving.

➤ **Front Seat P. 222**

Automatic Dimming Rearview Mirror*

The auto dimming function cancels when the shift position is in **R**.

Power Door Mirrors

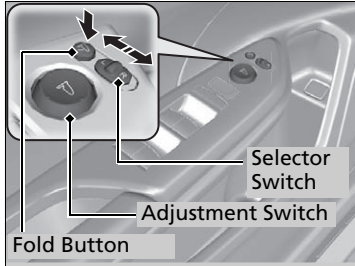

You can adjust the door mirrors when the ignition switch is in ON *¹.

■ Mirror position adjustment

L/R selector switch: Select the left or right mirror. After adjusting the mirror, return the switch to the centre position.

Mirror position adjustment switch: Press the switch left, right, up, or down to move the mirror.

■ Folding door mirrors*

Press the fold button to fold in and out the door mirrors.

* 1: Models with the keyless access system have an **ENGINE START/STOP** button instead of an ignition switch.

* Not available on all models

Front Seat

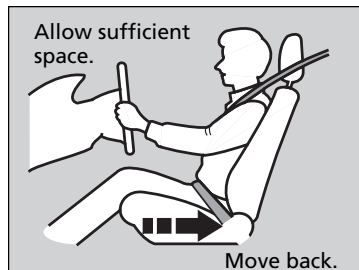

Adjust the driver's seat as far back as possible while allowing you to maintain full control of the vehicle. You should be able to sit upright, well back in the seat and be able to adequately press the pedals without leaning forward, and grip the steering wheel comfortably. The passenger's seat should be adjusted in a similar manner, so that it is as far back from the front airbag in the dashboard as possible.

Adjusting the Seats

WARNING

Sitting too close to a front airbag can result in serious injury or death if the front airbags inflate.

Always sit as far back from the front airbags as possible while maintaining control of the vehicle.

Allow at least 25 cm between the centre of the steering wheel and the chest.

Always make seat adjustments before driving.

■ Adjusting the Seat Positions

■ Adjusting the front manual seat(s)

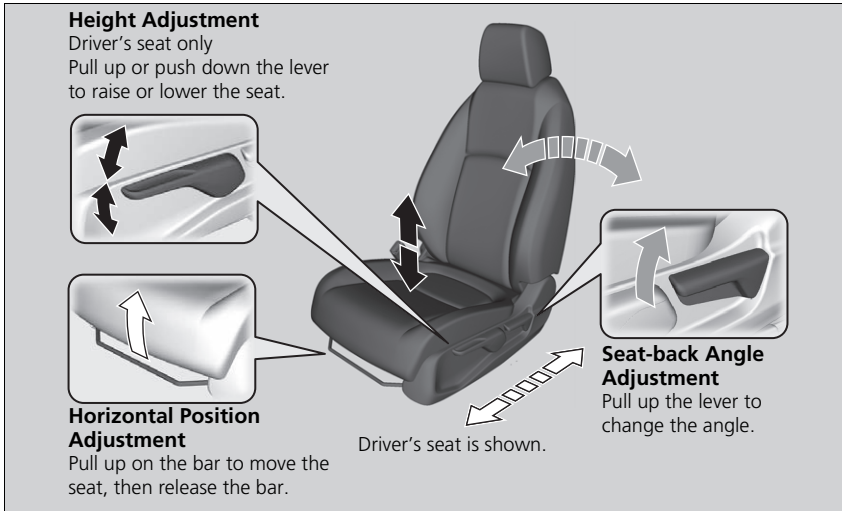

▣ Adjusting the front manual seat(s)

Once a seat is adjusted correctly, rock it back and forth to make sure it is locked in position.

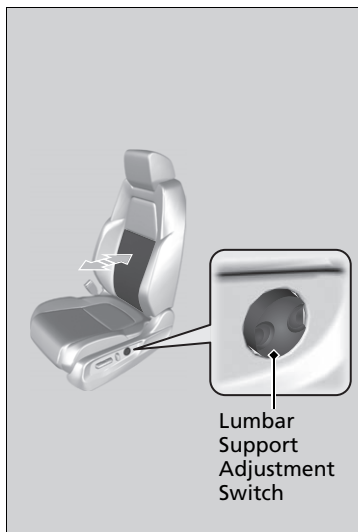

■ **Lumbar Support Adjustment Switch***

Press the front: To increase the entire lumbar support.

Press the rear: To decrease the entire lumbar support.

Adjusting the Seat-Backs

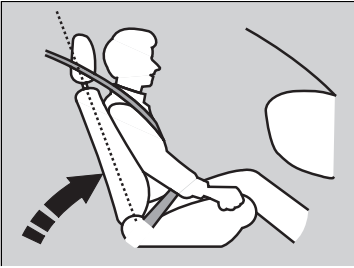

Adjust the driver's seat-back to a comfortable, upright position, leaving ample space between your chest and the airbag cover in the centre of the steering wheel.

The front seat passenger should also adjust their seat-back to a comfortable, upright position.

Reclining a seat-back so that the shoulder part of the belt no longer rests against the occupant's chest reduces the protective capability of the belt. It also increases the chance of sliding under the belt in a crash and being seriously injured. The farther a seat-back is reclined, the greater the risk of injury.

Adjusting the Seat-Backs

⚠ WARNING

Reclining the seat-back too far can result in serious injury or death in a crash.

Adjust the seat-back to an upright position, and sit well back in the seat.

Do not put a cushion, or other object, between the seat-back and your back.

Doing so may interfere with proper seat belt or airbag operation.

If you cannot get far enough away from the steering wheel and still reach the controls, we recommend that you investigate whether some type of adaptive equipment may help.

Head Restraints

Your vehicle is equipped with head restraints in all seating positions.

■ Adjusting the Front Head Restraints

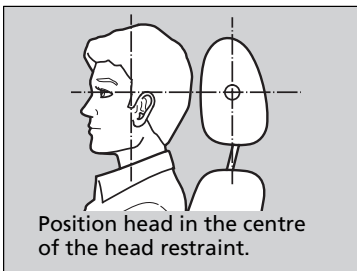

Front head restraints are most effective for protection against whiplash and other rear-impact crash injuries when the centre of the back of the occupant's head rests against the centre of the restraint. The tops of the occupant's ears should be level with the centre height of the restraint.

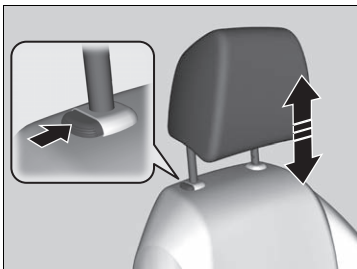

To raise the head restraint:

Pull it upward.

To lower the head restraint:

Push it down while pressing the release button.

► Adjusting the Front Head Restraints

⚠ WARNING

Improperly positioning head restraints reduces their effectiveness and increases the likelihood of serious injury in a crash.

Make sure head restraints are in place and positioned properly before driving.

In order for the head restraint system to work properly:

- Do not hang any items on the head restraints, or from the restraint legs.
- Do not place any object between an occupant and the seat-back.
- Install each restraint in its proper location.

■ Changing the Rear Seat Head Restraint Position

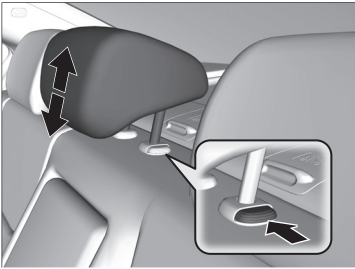

A passenger sitting in a back seating position should adjust the height of their head restraint to an appropriate position before the vehicle begins moving.

To raise the head restraint:

Pull it upward.

To lower the head restraint:

Push it down while pressing the release button.

■ Removing and Reinstalling the Head Restraints

Head restraints can be removed for cleaning or repair.

To remove a head restraint:

Pull the restraint up as far as it will go. Then push the release button, and pull the restraint up and out.

To reinstall a head restraint:

Insert the legs back in place, then adjust the head restraint to an appropriate height while pressing the release button. Pull up on the restraint to make sure it is locked in position.

Maintain a Proper Sitting Position

After all occupants have adjusted their seats and head restraints, and put on their seat belts, it is very important that they continue to sit upright, well back in their seats, with their feet on the floor, until the vehicle is safely parked and the engine is off.

Sitting improperly can increase the chance of injury during a crash. For example, if an occupant slouches, lies down, turns sideways, sits forward, leans forward or sideways, or puts one or both feet up, the chance of injury during a crash is greatly increased.

In addition, an occupant who is out of position in the front seat can be seriously or fatally injured in a crash by striking interior parts of the vehicle or being struck by an inflating front airbag.

⌘ Removing and Reinstalling the Head Restraints

WARNING

Failure to reinstall, or correctly reinstall, the head restraints can result in severe injury during a crash.

Always replace the head restraints before driving.

⌘ Maintain a Proper Sitting Position

WARNING

Sitting improperly or out of position can result in serious injury or death in a crash.

Always sit upright, well back in the seat, with your feet on the floor.

Rear Seats

Folding Down the Rear Seats

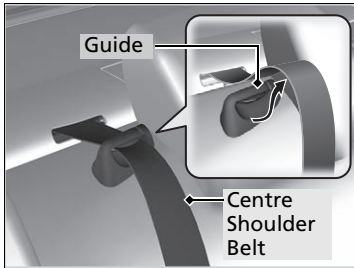

1. Remove the centre shoulder belt* from the guide.

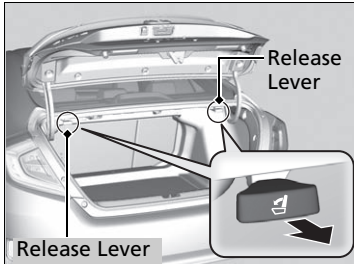

2. Pull the release lever* in the boot to release the lock.

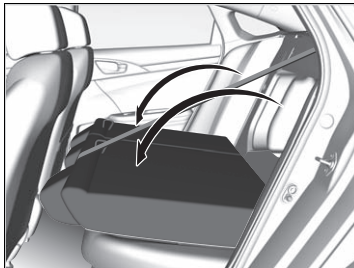

3. Fold the seat-back down.

Folding Down the Rear Seats

The rear seat-back(s*) can be folded down to accommodate bulkier items in the boot.

Never drive with the seat-back folded down and the boot lid open.

⚠ **Exhaust Gas Hazard** P. 90

To lock a seat-back upright, push it backwards until it locks.

When returning the seat-back to its original position, push it firmly back. Also, make sure all rear shoulder belts are positioned in front of the seat-back.

Make sure all items in the boot or items extending through the opening into the rear seats are properly secured. Loose items can fly forward if you have to brake hard.

The front seat(s) must be far enough forward so they do not interfere with the rear seats as they fold down.

* Not available on all models

Armrest

■ Using the Front Seat Armrest

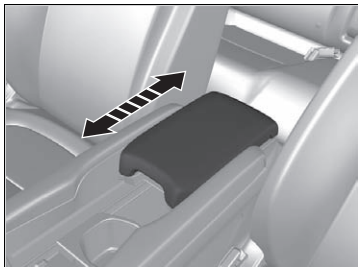

The console lid can be used as an armrest.

To adjust:

Slide the armrest to desired position.

■ Using the Rear Seat Armrest

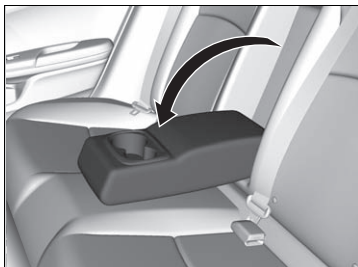

Pull down the armrest in the centre seat-back.

Interior Lights

Interior Light Switches

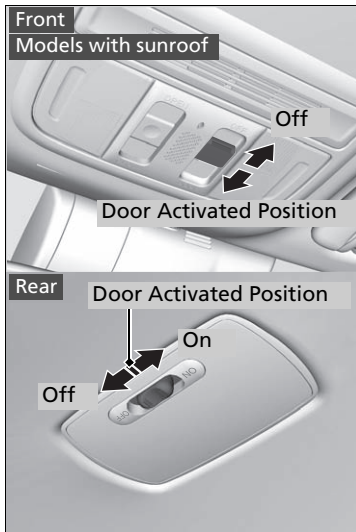

■ ON

The interior lights come on regardless of whether the doors are open or closed.

■ Door activated

The interior lights come on in the following situations:

- When any doors are opened.
- You unlock the driver's door.

■ Models without keyless access system

- You remove the key from the ignition switch.

■ Models with keyless access system

- When the power mode is set to VEHICLE OFF (LOCK).

■ OFF

The interior lights remain off regardless of whether the doors are open or closed.

▣ Interior Light Switches

In the door activated position, the interior lights fade out and go off about 30 seconds after the doors are closed. The lights go off after 30 seconds in the following situations:

- When you unlock the driver's door but do not open it.

■ Models without keyless access system

- When you remove the key from the ignition switch but do not open a door.

■ Models with keyless access system

- When you set the power mode to VEHICLE OFF (LOCK) but do not open a door.

■ Models with driver information interface

You can change the interior lights dimming time.

▣ **Customized Features** P. 359

The interior lights go off immediately in the following situations:

- When you lock the driver's door.
- When you turn the ignition switch to ON **II***1.

■ Models without keyless access system

- When you close the driver's door with the key in the ignition switch.

■ Models with keyless access system

- When you close the driver's door in ACCESSORY mode.

If you leave any of the doors open in VEHICLE OFF (LOCK) mode, or without the key in the ignition switch, the interior lights go off after about 15 minutes.

*1: Models with the keyless access system have an **ENGINE START/STOP** button instead of an ignition switch.

Map Lights

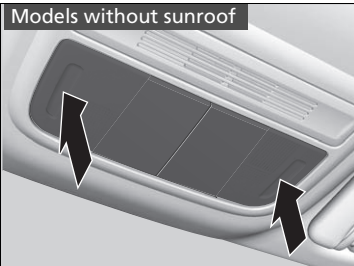
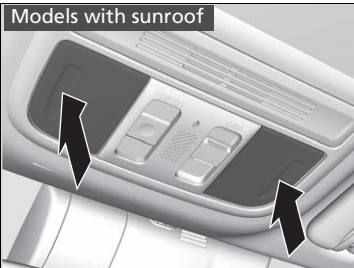

The map lights can be turned on and off by pressing the lenses.

Map Lights

Models with sunroof

When the ceiling light switch is in the door activated position and any door is open, the map light will not go off when you press the lens.

Interior Convenience Items

■ Glove Box

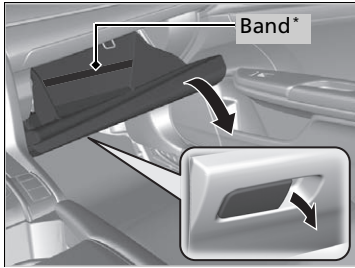

Pull the handle to open the glove box.

☒ Glove Box

⚠ WARNING

An open glove box can cause serious injury to your passenger in a crash, even if the passenger is wearing the seat belt.

Always keep the glove box closed while driving.

* Not available on all models

Continued

■ Console Compartment

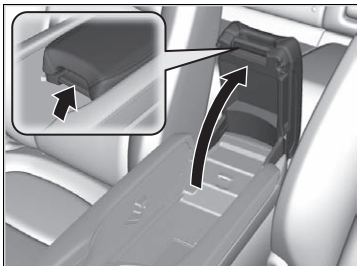

Your vehicle has a multi-function centre console. It includes a storage compartment and an armrest.

Slide the armrest to the rearmost position. Pull up on the handle to open the console compartment.

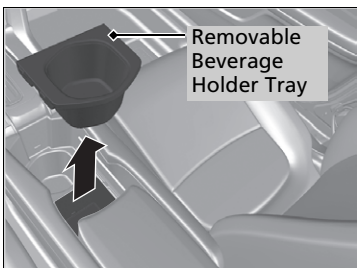

You can create more storage space by removing the removable beverage holder tray.

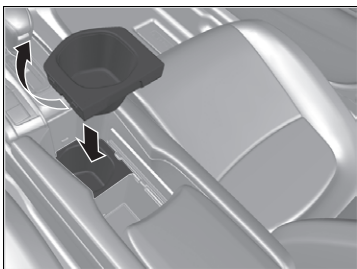

If you want to make greater use of the console box:

1. Raise the removable beverage holder tray and reverse its orientation.
2. Put the removable beverage holder on the beverage holder which is in front.

■ Beverage Holders

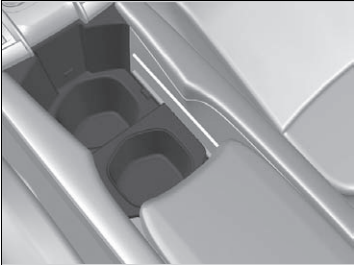

■ Front seat beverage holders

Are located in the console between the front seats.

- Move the armrest rearward to use the beverage holders.

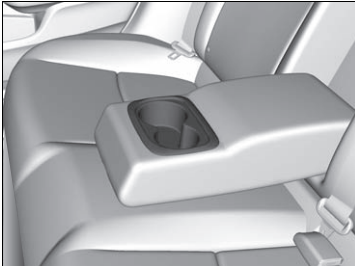

■ Rear seat beverage holders

Fold the armrest down to use the rear seat beverage holders.

☒ Beverage Holders

NOTICE

Spilled liquids damage the upholstery, carpeting, and electrical components in the interior.

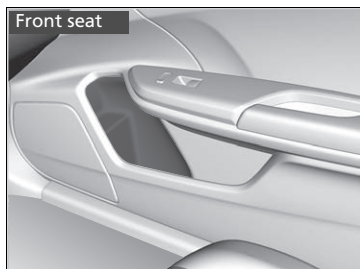

Be careful when you are using the beverage holders. Hot liquid can scald you.

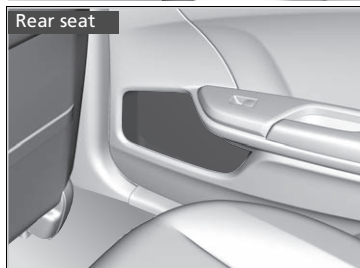

■ Door beverage holders



■ Accessory Power Socket

The accessory power socket can be used when the ignition switch is in ACCESSORY  or ON *1.

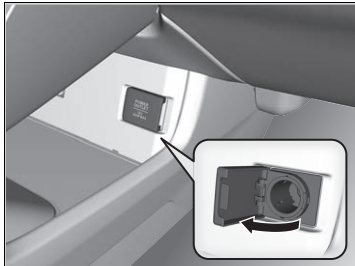

Open the cover to use it.

▣ Accessory Power Socket

NOTICE

Do not insert an automotive type cigarette lighter element: The power socket can overheat.

The accessory power socket is designed to supply power for 12-volt DC accessories that are rated 180 watts (15 amps) or less.

To prevent battery drain, use the power socket only when the engine is running.

*1: Models with the keyless access system have an **ENGINE START/STOP** button instead of an ignition switch.

■ Wireless Charger*

To use the wireless charger, the power mode must be in ACCESSORY or ON. Charge a compatible device on the area indicated by the  mark as follows:

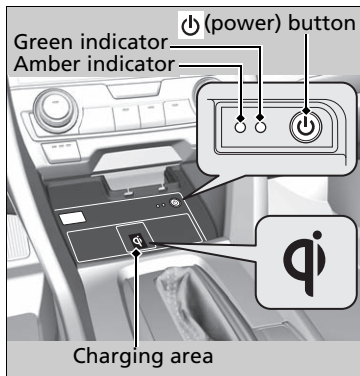

1. To turn the system on and off, press and hold the  (power) button.
 - ▶ When the system is activated, the green indicator light comes on.
2. Place the device you want to charge on the charging area.
 - ▶ The system will automatically start charging the device, and the amber indicator light will come on.
 - ▶ Make sure that the device is compatible with the system, and placed with the chargeable side in the centre of the charging area.
3. When charging is completed, the green indicator light will come on.
 - ▶ Depending on the device, the amber indicator light will stay on.

⚠ Wireless Charger*

⚠ WARNING

Metal objects between the charge pad and the device to be charged will get hot and can burn you.

- Always remove foreign objects from the charge pad before charging the device.
- Be sure the surface is clear of dust and other debris before charging.
- Do not spill liquids (i. e. water, drinks, etc.) on the charger and the device.
- Do not use oil, grease, alcohol, benzine or thinner for cleaning the charge pad.
- Do not cover the system with towels, clothing, or other objects while charging etc.
- Avoid spraying aerosols which may come in contact with the charge pad surface.

This system consumes a lot of power. Do not use the system for a long time when the engine is not running. This may weaken the battery, making it difficult to start the engine.

When using the wireless charger, check the user's manual that came with the compatible device you want to charge.

"Qi" and  marks are the registered trademarks owned by Wireless Power Consortium (WPC).

■ **When charging does not start**

Perform one of the solutions in the following table.

Indicator		Cause	Solution
Green & Amber	Blinking simultaneously	There is an obstacle(s) between the charging area and the device.	Remove the obstacle(s).
		The device is not within the charging area.	Move the device to the centre of the charging area where  is located.
Amber	Blinking	The wireless charger is faulty.	Contact a dealer for repairs.

Wireless Charger*

NOTICE

Do not place any magnetic recording media or precision machines within the charge area while charging. The data on your cards such as credit cards can be lost because of the magnetic effect. Also precision machines such as watches can go wrong.

In the following cases, charging may stop or not start:

- The device is already fully charged.
- The temperature of the device is extremely high while charging.
- You are at a place that emits strong electromagnetic wave or noises, such as TV station, electric power plant, or gas station.

A device may not charge if the size or shape of its chargeable side is not appropriate for use with the charging area.

Not all devices are compatible with the system.

During the charging phase, it is normal for the charging area and the device to heat up.

Charging may be briefly interrupted when:

- All doors or the boot are closed.
To avoid interference with the proper functioning of the keyless access system.
- The position of the device is altered.

Do not charge more than one device at a time on a charging area.

* Not available on all models

■ Coat Hooks

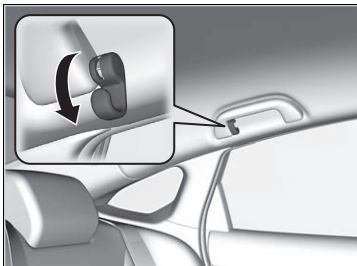

There is a coat hook on the rear left grab handle. Pull it down to use it.

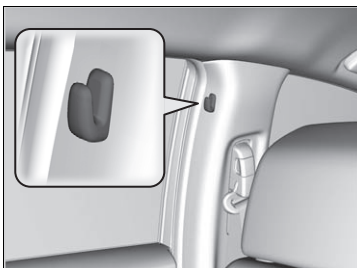

There are coat hooks on the left and right door pillars.

▣ Coat Hooks

The coat hook is not designed for large or heavy items.

■ Ashtray*

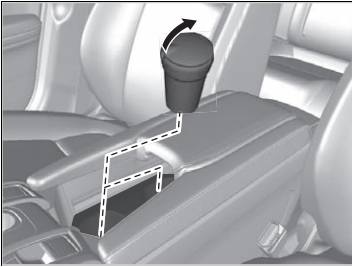

The ashtray that fits in the front beverage holders is removable. Pull up on the lid to open.

▣ Ashtray*

To prevent a possible fire and damage to your vehicle, use the ashtray only for discarding cigarettes and cigars.

* Not available on all models

Continued

■ Front Seat Heaters *



The ignition switch must be in ON *1 to use the seat heaters.

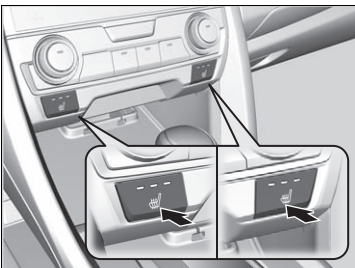

Press the seat heater button:

Once - The HI setting (three indicators on)

Twice - The MID setting (two indicators on)

Three times - The LO setting (one indicator on)

Four times - The OFF setting (no indicators on)

⌘ Front Seat Heaters *

WARNING

Heat induced burns are possible when using seat heaters.

Persons with a diminished ability to sense temperature (e.g., persons with diabetes, lower-limb nerve damage, or paralysis) or with sensitive skin should not use seat heaters.

Do not use the seat heaters even in LO when the engine is off. Under such conditions, the battery may be weakened, making the engine difficult to start.

*1: Models with the keyless access system have an **ENGINE START/STOP** button instead of an ignition switch.

Rear Seat Heaters*

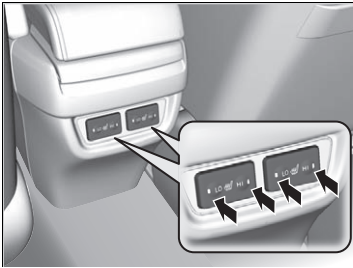

The ignition switch must be in ON **II***1 to use the seat heaters.

There is no heater in the rear centre seating position.

While in **HI**, the heater cycles on and off.

- The appropriate indicator will be on while the seat heater is on. When a comfortable temperature is reached, select **LO** to keep the seat warm.

*1: Models with the keyless access system have an **ENGINE START/STOP** button instead of an ignition switch.

* Not available on all models

⊠ Rear Seat Heaters*

⚠ WARNING

Heat induced burns are possible when using seat heaters.

Persons with a diminished ability to sense temperature (e.g., persons with diabetes, lower-limb nerve damage, or paralysis) or with sensitive skin should not use seat heaters.

Do not use the seat heaters even in **LO** when the engine is off. Under such conditions, the battery may be weakened, making the engine difficult to start.

Using Automatic Climate Control

The automatic climate control system maintains the interior temperature you select. The system also selects the proper mix of heated or cooled air that raises or lowers the interior temperature to your preference as quickly as possible.

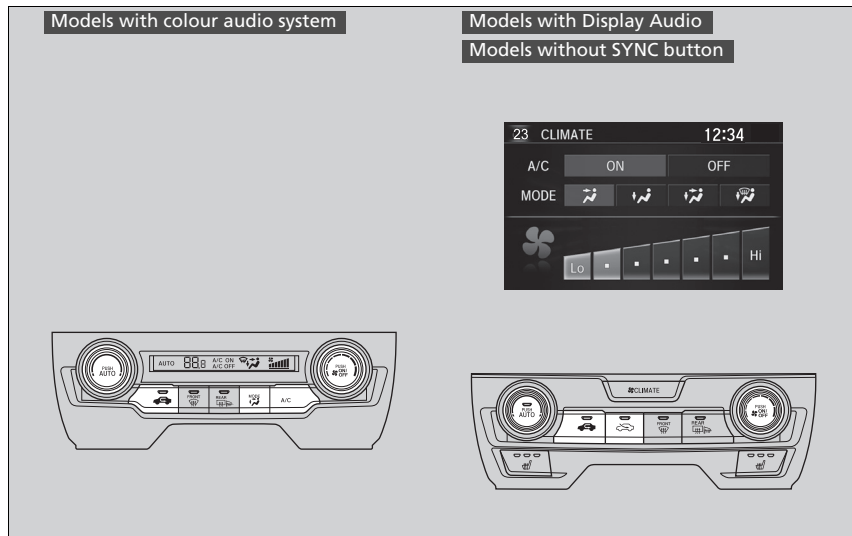

Use the system when the engine is running.

1. Press the **AUTO** button.
2. Adjust the interior temperature using the temperature control dial.
3. Press the  (on/off) button to cancel.

Using Automatic Climate Control

If any buttons are pressed while using the climate control system in auto, the function of the button that was pressed will take priority.

The **AUTO** indicator will go off, but functions unrelated to the button that were pressed will be controlled automatically.

Models with Auto Idle Stop

During idle-stops, air-conditioning is suspended, and only the blower remains active.

If you do not want air-conditioning suspended, press  to cancel Auto idle stop.

To prevent cold air from blowing in from outside, the fan may not start immediately when the **AUTO** button is pressed.

If the interior is very warm, you can cool it down more rapidly by partially opening the windows, turning the system on **AUTO**, and setting the temperature to low. Change the fresh mode to recirculation mode until the temperature cools down.

When you set the temperature to the lower or upper limit, **Lo** or **Hi** is displayed.

Models with Display Audio

Models with SYNC button

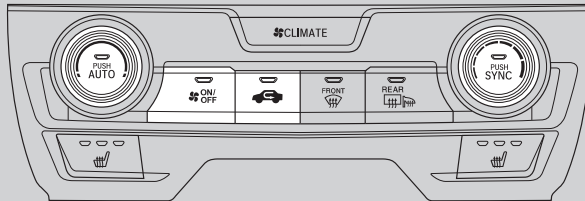

Use the system when the engine is running.

1. Press the **AUTO** button.
2. Adjust the interior temperature using the driver's side or passenger's side control dial.
3. Press the **ON/OFF** button to cancel.

Using Automatic Climate Control

Pressing the **ON/OFF** button switches the climate control system between on and off. When turned on, the system returns to your last selection.

While ECON mode is active, the climate control system may have reduced cooling performance.

Continued

■ Switching between the recirculation and fresh air modes

Models with colour audio system

Models with Display Audio

Models with SYNC button



Press the  (recirculation) button and switch the mode depending on environmental conditions.

Recirculation mode (indicator on): Recirculates air from the vehicle's interior through the system.

Fresh air mode (indicator off): Maintains outside ventilation. Keep the system in fresh air mode in normal situations.

Models with Display Audio

Models without SYNC button

Press the  (recirculation) or  (fresh air) button to switch the mode depending on environmental conditions.

 Recirculation mode (indicator on): Recirculates air from the vehicle's interior through the system.

 Fresh air mode (indicator on): Maintains outside ventilation. Keep the system in fresh air mode in normal situations.

Defrosting the Windscreen and Windows

Models with colour audio system

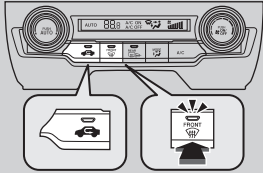

Pressing the  (windscreen demister) button turns the air conditioning system on and automatically switches the system to fresh air mode.

Press the  button again to turn off, the system returns to the previous settings.

Models with Display Audio

Models without SYNC button

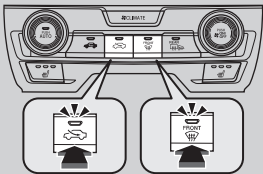

Models with Display Audio

Models with SYNC button

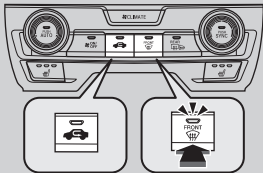

Defrosting the Windscreen and Windows

For your safety, make sure you have a clear view through all the windows before driving.

Do not set the temperature near the upper or lower limit.

When cold air hits the windscreen, the outside of the windscreen may fog up.

If the side windows fog up, adjust the vents so that the air hits the side windows.

Models with Auto Idle Stop

If you press the  button during auto idle stop, the engine restarts automatically.

■ To rapidly defrost the windows

Models with colour audio system

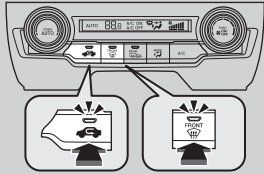

1. Press the  button.
2. Press the  button.

Models with Display Audio
Models without SYNC button

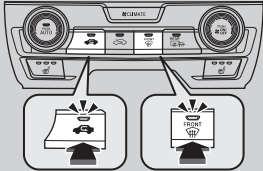

Models with Display Audio
Models with SYNC button

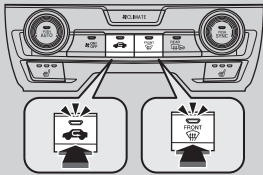

►► To rapidly defrost the windows

After defrosting the windows, switch over to fresh air mode. If you keep the system in recirculation mode, the windows may fog up from humidity. This impedes visibility.

Synchronized Mode*

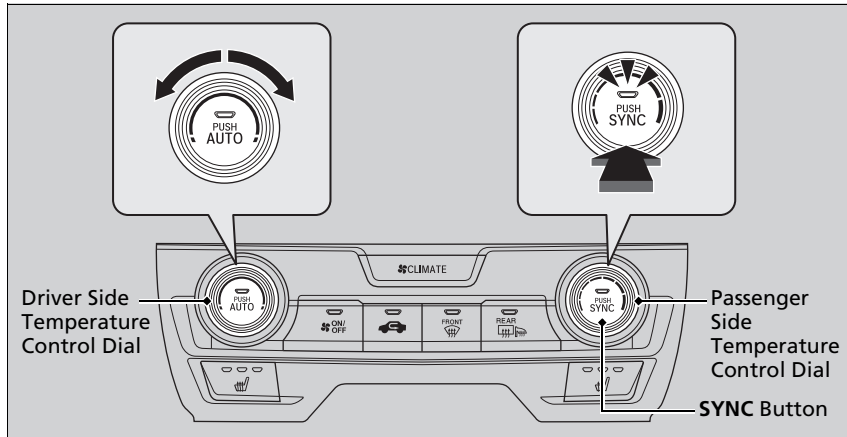

☒ Synchronized Mode*

When the system is in dual mode, the driver's side temperature and the passenger's side temperature can be set separately.

You can set the temperature synchronously for the driver's side and the passenger's side in synchronized mode.

1. Press the **SYNC** button.
 - The system switches to synchronized mode.
2. Adjust the temperature using the driver's side temperature control dial.

Press the **SYNC** button to return to dual mode.

* Not available on all models

Automatic Climate Control Sensors

Models without automatic intermittent wiper

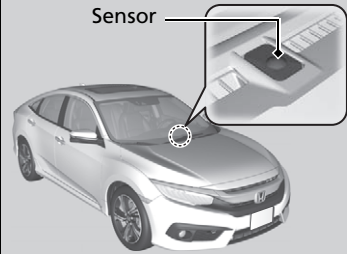

Models with automatic intermittent wiper

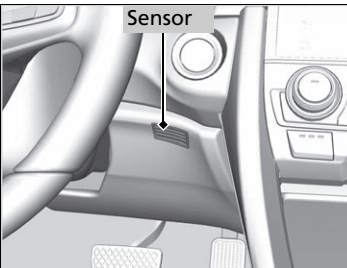
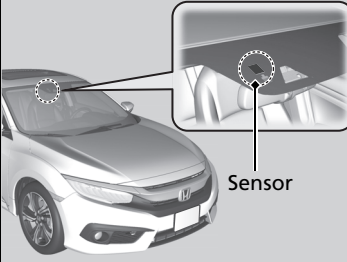

The automatic climate control system is equipped with sensors. Do not cover or spill any liquid on them.

Features

This chapter describes how to operate technology features.

Audio System		
About Your Audio System	252	
USB Port(s)	253	
HDMI™ Port*	255	
Audio System Theft Protection*	256	
Audio Remote Controls	257	
Models with colour audio system		
Audio System Basic Operation		
Audio/Information Screen	262	
Adjusting the Sound	266	
Display Setup	267	
Playing AM/FM Radio	268	
Playing DAB (Digital Audio Broadcasting)* ...	274	
Playing an iPod	277	
Playing a USB Flash Drive	280	
Playing <i>Bluetooth</i> ® Audio	283	
Models with Display Audio		
Audio System Basic Operation		
Audio/Information Screen	287	
Adjusting the Sound	308	
Display Setup	309	
Playing AM/FM Radio	315	
Playing DAB (Digital Audio Broadcasting)* ...	318	
Playing an iPod	321	
Playing Aha™*	328	
Playing a USB Flash Drive	329	
Playing <i>Bluetooth</i> ® Audio	332	
Playing a Video Using the HDMI™	334	
On Board Apps*	336	
Smartphone Connection	337	
Wi-Fi Connection	340	
Siri Eyes Free	342	
Apple CarPlay	343	
Android Auto	346	
Audio Error Messages	350	
General Information on the Audio System	353	
Customized Features	359	
Models with colour audio system		
Hands-Free Telephone System	394	
Models with Display Audio		
Hands-Free Telephone System	415	

* Not available on all models

About Your Audio System

The audio system features AM/FM radio. It can also play USB flash drives, and iPod, iPhone, *Bluetooth*®, and HDMI™* devices.

You can operate the audio system from the buttons and switches on the panel, the remote controls on the steering wheel, or the icons on the touchscreen interface*.

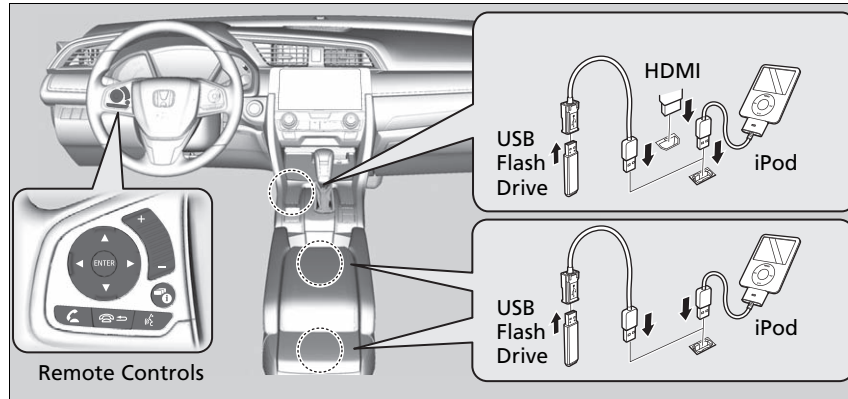

About Your Audio System

iPod, iPhone and iTunes are trademarks of Apple Inc.

USB Port(s)

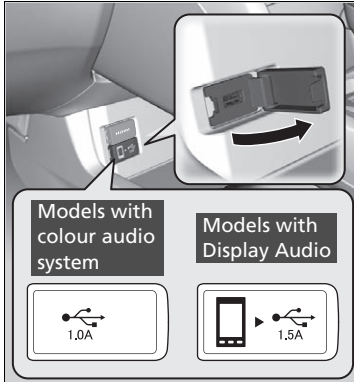

Install the iPod USB connector or the USB flash drive to the USB port.

Models with colour audio system

- ▶ The USB port (1.0A) is for playing audio files on a USB flash drive, connecting a mobile phone, and charging devices.

Models with Display Audio

- ▶ The USB port (1.5A) is for charging devices, playing audio files and connecting compatible phones with smartphone connection, Apple CarPlay or Android Auto.

USB Port(s)

- Do not leave the iPod or USB flash drive in the vehicle. Direct sunlight and high temperatures may damage it.
- We recommend using an extension cable with the USB port.
- Do not connect the iPod or USB flash drive using a hub.
- Do not use a device such as a card reader or hard disk drive, as the device or your files may be damaged.
- We recommend keeping your data backed up before using the device in your vehicle.
- Displayed messages may vary depending on the device model and software version.

If the audio system does not recognize the iPod, try reconnecting it a few times or reboot the device. To reboot, follow the manufacturer's instructions provided with the iPod or visit www.apple.com/ipod.

USB charge

The USB port can supply up to 1.0A/1.5A of power. It does not output 1.0A/1.5A unless requested by the device.

For amperage details, read the operating manual of the device that needs to be charged.

Turn the ignition switch to ACCESSORY **I** or ON **II***1 first.

Under certain conditions, a device connected to the port may generate noise in the radio you are listening to.

*1: Models with the keyless access system have an **ENGINE START/STOP** button instead of an ignition switch.

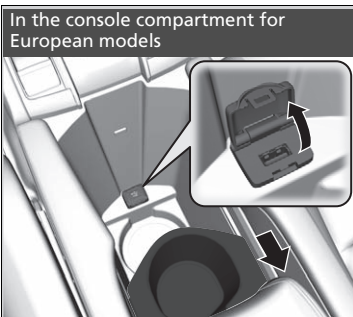

■ **In the console compartment***

The USB port (1.0A) is for playing audio files on the USB flash drive, connecting a mobile phone, and charging devices.

In the console compartment for European models

- ▶ Move the removable beverage holder tray rearward.

HDMI™ Port*

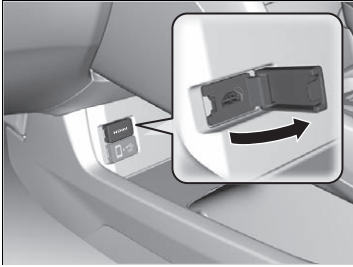

1. Open the cover.
2. Install the HDMI™ cable to the HDMI™ port.

⊠ HDMI™ Port*

- Do not leave the HDMI™ connected device in the vehicle. Direct sunlight and high temperatures may damage it.
- We recommend keeping your data backed up before using the device in your vehicle.
- Displayed messages may vary depending on the device model and software version.

The terms HDMI and HDMI High-Definition Multimedia Interface, and the HDMI Logo are trademarks or registered trademarks of HDMI Licensing LLC in the United States and other countries.

* Not available on all models

Audio System Theft Protection*

The audio system is disabled when it is disconnected from the power source, such as when the battery is disconnected or goes dead. In certain conditions, the system may display a code entry screen. If this occurs, reactivate the audio system.

■ Reactivating the audio system

1. Turn the ignition switch to ON *1.
2. Turn on the audio system.
3. Press and hold the audio system power button for more than two seconds.
 - ▶ The audio system is reactivated when the audio control unit establishes a connection with the vehicle control unit. If the control unit fails to recognize the audio unit, you must go to a dealer and have the audio unit checked.

*1: Models with the keyless access system have an **ENGINE START/STOP** button instead of an ignition switch.

Audio Remote Controls

Models with information display

Allow you to operate the audio system while driving.

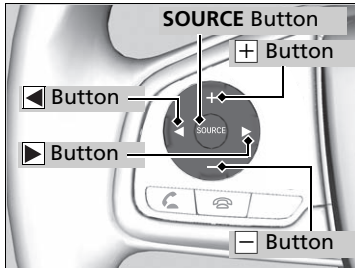

SOURCE Button

Cycles through the audio modes as follows:
 FM1→FM2→DAB1*→DAB2*→LW*→AM (MW*)
 →USB→iPod→*Bluetooth*® Audio

+ - (Volume) Buttons

Press +: To increase the volume.

Press -: To decrease the volume.

◀ ▶ Buttons

- When listening to the radio
 - Press** ▶: To select the next preset radio station.
 - Press** ◀: To select the previous preset radio station.
 - Press and hold** ▶: To select the next station with strong reception.
 - Press and hold** ◀: To select the previous station with strong reception.
- When listening to an iPod, USB flash drive, or *Bluetooth*® Audio
 - Press** ▶: To skip to the next song.
 - Press** ◀: To go back to the beginning of the current or previous song.
- When listening to a USB flash or *Bluetooth*® Audio
 - Press and hold** ▶: To skip to the next folder.
 - Press and hold** ◀: To go back to the previous folder.

▶▶ Audio Remote Controls

Some modes appear only when an appropriate device or medium is used.

Depending on the *Bluetooth*® device you connect, some functions may not be available.

* Not available on all models

Models with driver information interface

Allow you to operate the audio system while driving. The information is shown on the driver information interface.

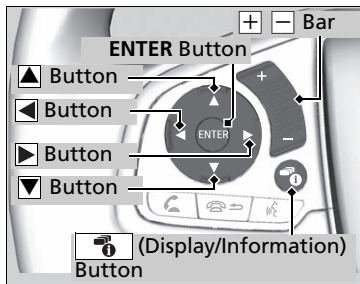

▲ ▼ Buttons

Press ▲ or ▼ to cycle through the audio mode as follows:

Models with colour audio system

FM1→FM2→DAB1*→DAB2*→LW→AM (MW*)→USB→iPod→Bluetooth® Audio

Models with Display Audio

FM→DAB*→LW*→AM→MW*→USB→iPod→Bluetooth® Audio→Apps*→Audio Apps*→AUX-HDMI™

▶▶ Audio Remote Controls

Some modes appear only when an appropriate device or medium is used.

Depending on the *Bluetooth*® device you connect, some functions may not be available.

Press the (Hang-up/back) button to go back to the previous command or cancel a command.

Press the (Display/information) button to switch the display.

▶ Switching the Display P. 287

Models with Display Audio**ENTER Button**

- When listening to the radio
 1. From the audio screen in the driver information interface, press **ENTER** to switch the display to a preset list you stored in the preset buttons.
 2. Press ▲ or ▼ to select a preset, then press **ENTER**.
- When listening to a USB flash drive
 1. From the audio screen in the driver information interface, press **ENTER** to display the folder list.
 2. Press ▲ or ▼ to select a folder.
 3. Press **ENTER** to display a list of tracks in that folder.
 4. Press ▲ or ▼ to select a track, then press **ENTER**.

You can also swipe up or down to scroll through the list of tracks alphabetically.

- When listening to an iPod
 1. From the audio screen in the driver information interface, press **ENTER** to display the iPod music list.
 2. Press ▲ or ▼ to select a category.
 3. Press **ENTER** to display a list of items in the category.
 4. Press ▲ or ▼ to select an item, then press **ENTER**.
 - ▶ Press **ENTER** and press ▲ or ▼ repeatedly until the desired mode you want to listen to is displayed.

You can also swipe up or down to scroll through the list of tracks alphabetically.

- When listening to *Bluetooth*® Audio
 1. From the audio screen in the driver information interface, press **ENTER** to display the track list.
 2. Press ▲ or ▼ to select a track, then press **ENTER**.

(Volume) Bar

Press : To increase the volume.

Press : To decrease the volume.

Models with Display Audio

Swipe down quickly to mute the volume or swipe up to cancel the mute.

Buttons

- When listening to the radio

Press : To select the next preset radio station.

Press : To select the previous preset radio station.

Press and hold : To select the next strong station.

To select the next service (DAB).*

Press and hold : To select the previous strong station.

To select the previous service (DAB).*

- When listening to an iPod, USB flash drive, or *Bluetooth*® Audio

Press : To skip to the next song.

Press : To go back to the beginning of the current or previous song.

- When listening to a USB flash drive

Press and hold : To skip to the next folder.

Press and hold : To go back to the previous folder.

Models with colour audio system

To use the audio system, the ignition switch must be in ACCESSORY **I** or ON **II***1.

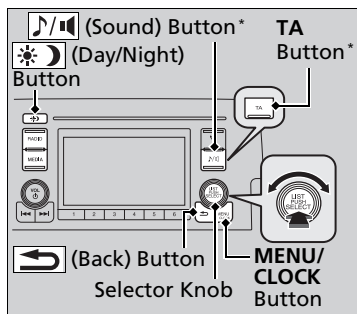

Use the selector knob or **MENU/CLOCK** button to access some audio functions.

Press to switch between the normal and extended display for some functions.

Selector knob: Rotate left or right to scroll through the available choices. Press to set your selection.

MENU/CLOCK button: Press to select any mode.

The available mode includes the wallpaper, display, clock, language setup, and play modes. Play modes can be also selected from scan, random, repeat, and so on.

(Back) button: Press to go back to the previous display.

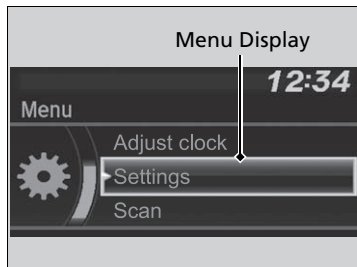

(Sound) button*: Press to select the sound setting mode.

TA button*: Press to activate the TA station.

(Day/Night) button: Press to change the audio/information screen brightness. Press the , then adjust the brightness using .

► Each time you press the , the mode switches between the daytime mode, nighttime mode and **OFF** mode.

*1: Models with the keyless access system have an **ENGINE START/STOP** button instead of an ignition switch.

* Not available on all models

Audio System Basic Operation

These indications are used to show how to operate the selector knob.

Rotate to select.

Press to enter.

Menu Items

- **Adjust Clock** P. 170
- **Wallpaper Setup** P. 264
- **Display Setup** P. 267
- **Scan** P. 273, 282
- **Play Mode** P. 279, 282
- **RDS Settings** P. 269
- **Bluetooth** P. 283

Press the **SOURCE**, , , , or button on the steering wheel to change any audio setting.

➤ **Audio Remote Controls** P. 257

Audio/Information Screen

Displays the audio status and wallpaper. From this screen, you can go to various setup options.

■ Switching the Display

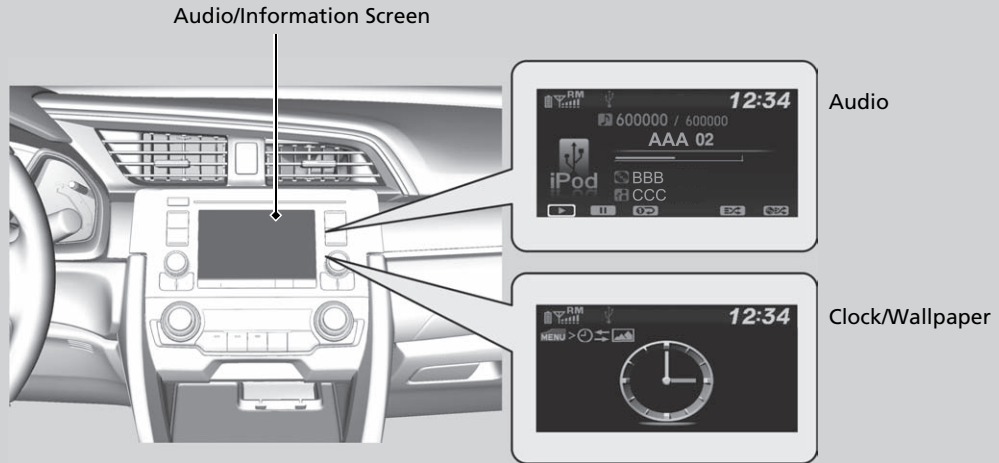







■ Audio

Shows the current audio information.

■ Clock/Wallpaper

Shows a clock screen or an image you import.

■ Change display

1. Press the **MENU/CLOCK** button.
2. Rotate  to select **Settings**, then press .
3. Rotate  to select **Display change**, then press .
4. Rotate  to select **Wallpaper**, then press 
 - ▶ If you want to return to the audio/information screen, select **Audio**.

■ Wallpaper Setup

You can change, store, and delete the wallpaper on the audio/information screen.

■ Import wallpaper

You can import up to three images, one at a time, for wallpaper from a USB flash drive.

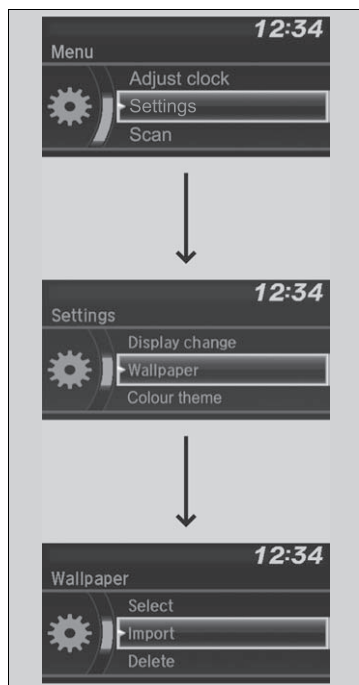









1. Connect the USB flash drive to the USB port.
 ▶ **USB Port(s)** P. 253
2. Press the **MENU/CLOCK** button.
3. Rotate to select **Settings**, then press .
4. Rotate to select **Wallpaper**, then press .
5. Rotate to select **Import**, then press .
 ▶ The picture name is displayed on the list.
6. Rotate to select a desired picture, then press .
 ▶ The selected picture is displayed.
7. Press to save the picture.
8. Press to select **OK**.
9. Rotate to select a location to save the picture, then press .
 ▶ The display will return to the wallpaper setting screen.









▶▶ Wallpaper Setup

- When importing wallpaper files, the image must be in the USB flash drive's root directory. Images in a folder cannot be imported.
- The file name must be fewer than 64 characters.
- The file format of the image that can be imported is BMP (bmp) or JPEG (jpg).
- The individual file size limit is 2 MB.
- The maximum image size is 1,920 x 936 pixels. If the image size is less than 480 x 234 pixels, the image is displayed in the middle of the screen with the extra area appearing in black.
- Up to 255 files can be selected.
- If the USB flash drive does not have any pictures, the error message appears.











■ Select wallpaper

1. Press the **MENU/CLOCK** button.
2. Rotate  to select **Settings**, then press .
3. Rotate  to select **Wallpaper**, then press .
4. Rotate  to select **Select**, then press .
 - ▶ The screen changes to the wallpaper list.
5. Rotate  to select a desired wallpaper, then press .

■ To view wallpaper once it is set

1. Press the **MENU/CLOCK** button.
2. Rotate  to select **Settings**, then press .
3. Rotate  to select **Display change**, then press .
4. Rotate  to select **Wallpaper**, then press .
 - ▶ The screen changes to the wallpaper list.
5. Rotate  to select a wallpaper that you want to set, then press .

■ Delete wallpaper

1. Press the **MENU/CLOCK** button.
2. Rotate  to select **Settings**, then press .
3. Rotate  to select **Wallpaper**, then press .
4. Rotate  to select **Delete**, then press .
 - ▶ The screen changes to the wallpaper list.
5. Rotate  to select a wallpaper that you want to delete, then press .
6. Rotate  to select **Yes**, then press .
 - ▶ The display will return to the wallpaper setting screen.

Wallpaper Setup

To go back to the previous screen, press the  (Back) button.

When the file size is large, it takes a while to be previewed.

Adjusting the Sound

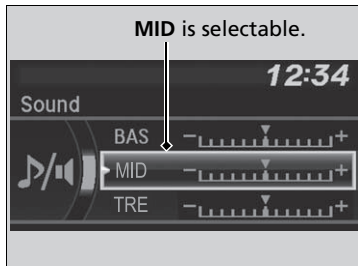
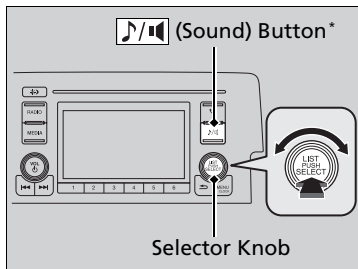

Models with (sound) button

Press the (sound) button, and rotate to scroll through the following choices:

Models without (sound) button

Press the **MENU/CLOCK** button and rotate to select **Sound**, then press . Rotate to scroll through the following choices:

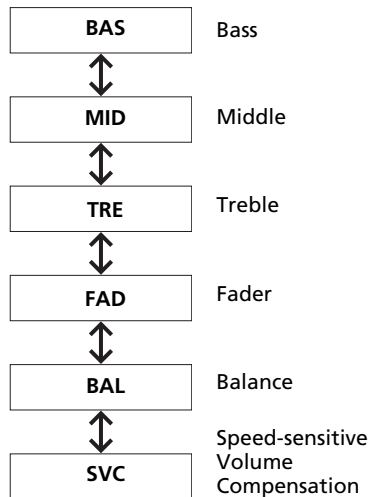

Rotate to adjust the sound setting, then press .

▶▶ Adjusting the Sound

The SVC has four modes: **Off**, **Low**, **Mid**, and **High**. SVC adjusts the volume level based on the vehicle speed. As you go faster, audio volume increases. As you slow down, audio volume decreases.

Display Setup

You can change the brightness or colour theme of the audio/information screen.

Changing the Screen Brightness

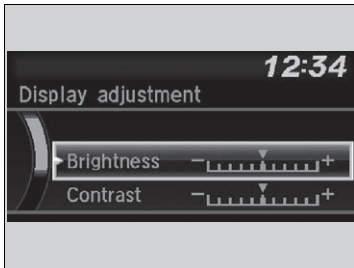

1. Press the **MENU/CLOCK** button.
2. Rotate to select **Settings**, then press .
3. Rotate to select **Display adjustment**, then press .
4. Rotate to select **Brightness**, then press .
5. Rotate to adjust the setting, then press .

Changing the Screen's Colour Theme

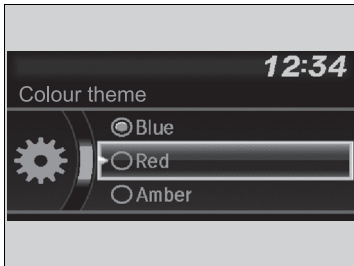

1. Press the **MENU/CLOCK** button.
2. Rotate to select **Settings**, then press .
3. Rotate to select **Colour theme**, then press .
4. Rotate to select the setting you want, then press .

Changing the Screen Brightness

You can change the **Contrast** and **Black level** settings in the same manner.

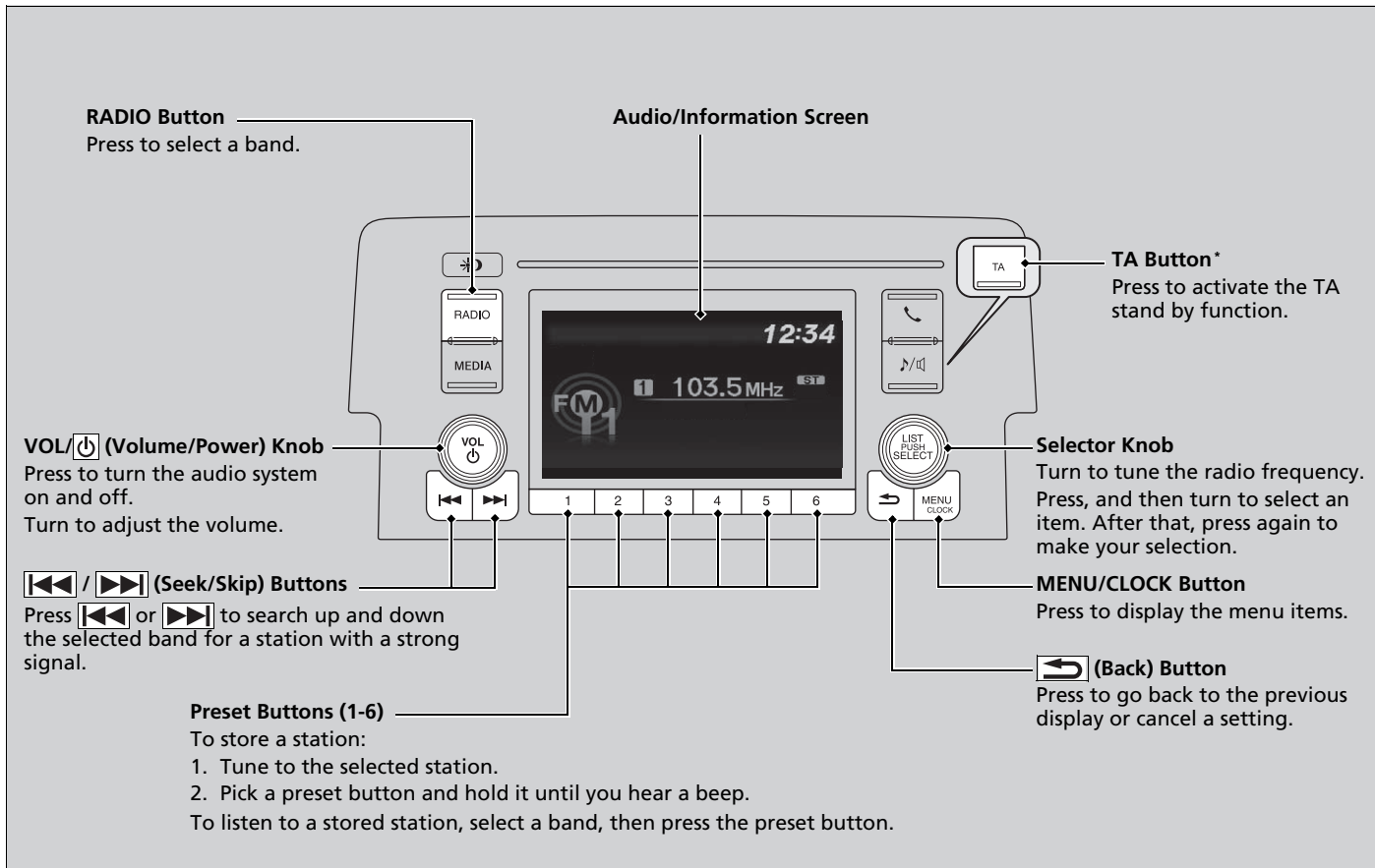

Playing AM/FM Radio



Radio Data System (RDS)*



Provides text data information related to your selected RDS capable FM station.

■ To find an RDS station from Station List

1. Press  while listening to an FM station.
2. Rotate  to select the station, then press .







■ Update List

Updates your available station list at any time.

1. Press  while listening to an FM station.
2. Rotate  to select **Update list**, then press .

■ Radio text

Displays the radio text information of the selected RDS station.

1. Press the **MENU/CLOCK** button.
2. Rotate  to select **Settings**, then press .
3. Rotate  to select **RDS settings**, then press .
4. Rotate  to select **Radio text**, then press .
 - ▶ Select **Radio text** again to turn it off.

▶▶ Playing AM/FM Radio

The **ST** indicator appears on the display indicating stereo FM broadcasts.
Stereo reproduction in AM is not available.

You can store 12 AM stations and 12 FM stations into the preset button memory. AM has two types of frequencies LW and MW, and each lets you store six stations. FM1 and FM2 let you store six stations each.

Switching the Audio Mode

Press the **SOURCE** button on the steering wheel.

▶ **Audio Remote Controls** P. 257

▶▶ Radio Data System (RDS)*







When you select an RDS-capable FM station, the RDS automatically turns on, and the frequency display changes to the station name. However, when the signals of that station become weak, the display changes from the station name to the frequency.

Turning the Alternative Frequency (AF) function on and off turns the RDS on and off.

Pressing  switches the function between on and off.







■ Alternative Frequency (AF)

Automatically changes the frequency of the same programme as you enter different regions.

1. Press the **MENU/CLOCK** button.
2. Rotate  to select **Settings**, then press .
3. Rotate  to select **RDS settings**, then press .
4. Rotate  to select **AF**, then press .
 - ▶ Select **AF** again to turn it off.

■ Regional Programme (REG)







Keeps the same frequency of the stations within that region even if the signal gets weak.

1. Press the **MENU/CLOCK** button.
2. Rotate  to select **Settings**, then press .
3. Rotate  to select **RDS settings**, then press .
4. Rotate  to select **REG**, then press .
 - ▶ Select **REG** again to turn it off.



Except AM/FM/DAB* mode

■ News Programme (News)

Automatically tunes to the news programme.

1. Press the **MENU/CLOCK** button.
2. Rotate  to select **Settings**, then press .
3. Rotate  to select **RDS settings**, then press .
4. Rotate  to select **News**, then press .
 - ▶ Select **News** again to turn it off.

▶▶ Radio Data System (RDS)*

If the system cannot find any station on **Station list**, a confirmation message for updating the list appears. Rotate  to select **Yes**, then press  to update the list.

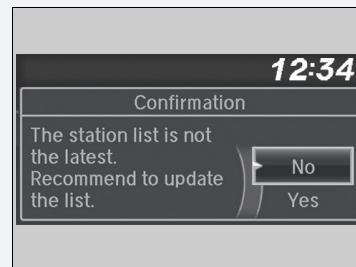

■ Traffic announcement (TA) button

TA standby function allows the system to stand by for traffic announcements in any mode. The last tuned station must be an RDS-capable traffic programme station.

To turn the function on: Press the **TA** button. When a traffic announcement begins on your last tuned station, the system automatically switches to the FM mode. TA-INFO appears on the display. The system returns to your last selected mode after the traffic announcement is finished.

If you want to go back to your last selected mode during the traffic announcement, press the **TA** button again.

To cancel the function: Press the **TA** button.

☒ Radio Data System (RDS)*

TA*

When you press the **TA** button, the **TA** indicator appears on the display.

If you select **Scan** while the TA standby function is on, the system searches TP station only.

Pressing the **TA** button while the traffic announcement is on does not cancel the TA standby function.

* Not available on all models

Except AM/FM/DAB* mode

■ Programme type (PTY)/News interrupt function

Allows the system to interrupt with a newscast in any mode. The last tuned station must be the NEWS PTY coded station.

To activate the function: Select **News** from **RDS settings** and display the NEWS PTY before changing to other modes. When a newscast begins on your last tuned station, the system automatically switches to the FM mode.

➤ **News Programme (News)** P. 270

The system returns to your last selected mode if changed to another programme, or signal gets weak.



■ PTY alarm

The PTY code, ALARM is used for emergency announcements, such as natural disasters. When this code is received, ALARM appears on the display and the system interrupts your audio operation.

AM (LW/MW) mode



Station List

Lists the strongest stations on the selected band.

1. Press  while listening to an AM station.
2. Rotate  to select the station, then press .

Update List

Updates your available station list at any time.

1. Press  while listening to an AM station.
2. Rotate  to select **Update list**, then press .



Scan

Samples each of the strongest stations on the selected band for 10 seconds.

1. Press the **MENU/CLOCK** button.
2. Rotate  to select **Scan**, then press .

To turn off scan, press .

▶▶ Station List

If the system cannot find any station on **Station list**, a confirmation message for updating the list appears. Rotate  to select **Yes**, then press  to update the list.

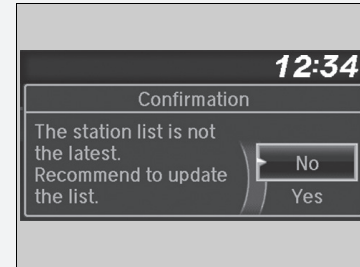

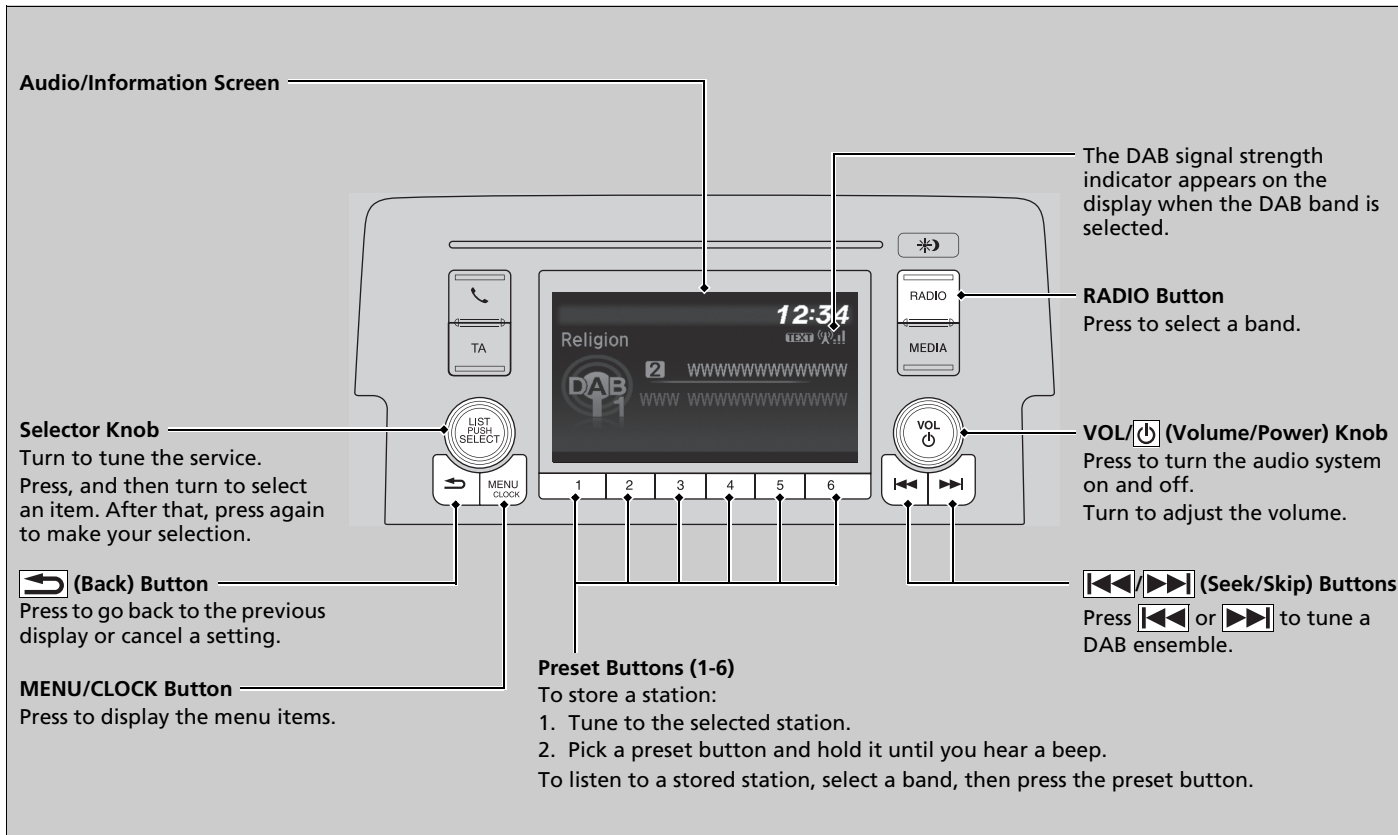

Playing DAB (Digital Audio Broadcasting)*







Service List and Ensemble List

■ To find a DAB station from Service List or Ensemble List

To find a DAB station from the service list:

1. Press  while selecting the DAB mode.
2. Rotate  to select the station, then press .
 - ▶ If you select **Update list**, the system update the station list.

To find a DAB station from the ensemble list:

1. Press  while selecting the DAB mode.
2. Rotate  to select **Ensemble list**, then press .
3. Rotate  to select the ensemble, then press .
 - ▶ If you select **Update list**, the system update the ensemble list.

■ Scan







Samples each of the strongest stations on the selected band for 10 seconds.

1. Press the **MENU/CLOCK** button.
2. Rotate  to select **Scan**, then press .

To turn off scan, press .

■ Radio Text:

Displays the radio text information of the selected DAB station.

1. Press the **MENU/CLOCK** button.
2. Rotate  to select **Settings**, then press .
3. Rotate  to select **DAB settings**, then press .
4. Rotate  to select **Radio text**, then press .
 - ▶ Select **Radio text** again to turn it off.



▶▶ Service List and Ensemble List

You can store 12 DAB stations into the preset button memory. DAB1 and DAB2 let you store 6 stations each.

Switching the Audio Mode

Press the audio source selecting button on the steering wheel.

▶▶ **Audio Remote Controls** P. 257

If the system cannot find a station, a confirmation message for updating the list appears. Rotate  to select **Yes**, then press  to update the list.

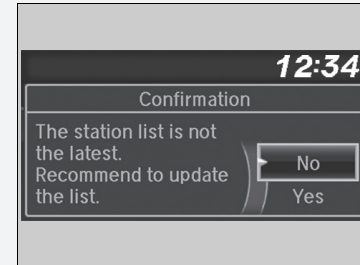







▶▶ Radio Text:

The **TEXT** indicator appears on the display indicating radio text information.







■ DAB-Link:

Automatically searches for the same station from Ensembles, and switches to it.

1. Press the **MENU/CLOCK** button.
2. Rotate  to select **Settings**, then press .
3. Rotate  to select **DAB settings**, then press .
4. Rotate  to select **DAB-Link**, then press .
 - ▶ Select **DAB-Link** again to turn it off.









■ FM-Link:

If the system finds the same station from an FM band, it automatically switches the band.

1. Press the **MENU/CLOCK** button.
2. Rotate  to select **Settings**, then press .
3. Rotate  to select **DAB settings**, then press .
4. Rotate  to select **FM-Link**, then press .
 - ▶ Select **FM-Link** again to turn it off.

■ Band select:

You can select specific bands. This can reduce the time to update the lists, and search for a station.

1. Press the **MENU/CLOCK** button.
2. Rotate  to select **Settings**, then press .
3. Rotate  to select **DAB settings**, then press .
4. Rotate  to select **Band select**, then press .
5. Rotate  to select **Both**, **BandIII** or **L-Band**, then press .

Playing an iPod

Connect the iPod using your USB connector to the USB port, then press the **MEDIA** button.

🔌 **USB Port(s)** P. 253

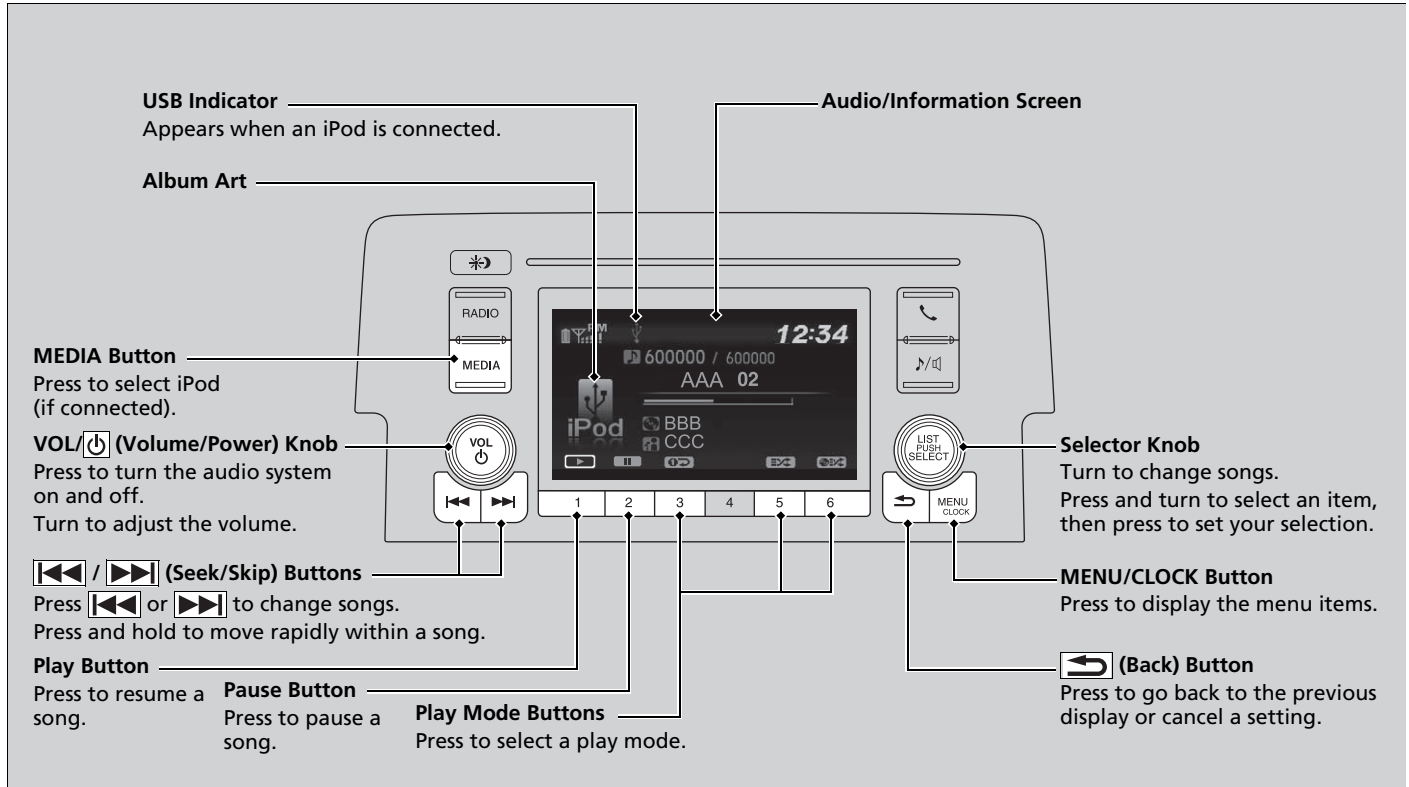

How to Select a Song from the iPod Music List with the Selector Knob

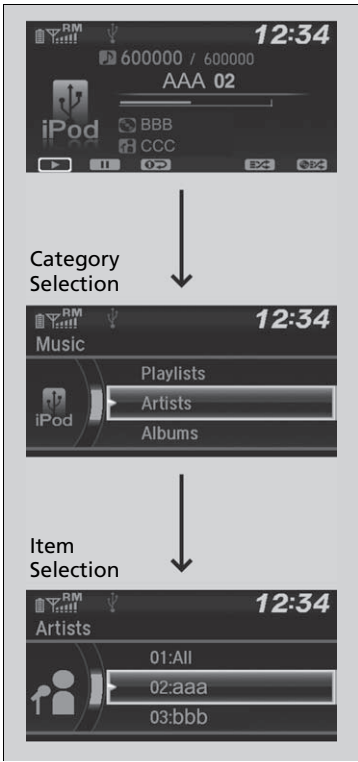

1. Press to display the iPod music list.

2. Rotate to select a category.

3. Press to display a list of items in the category.

4. Rotate to select an item, then press .
▶ Press and rotate repeatedly until a desired item you want to listen is displayed.

▶▶ Playing DAB (Digital Audio Broadcasting)*

Available operating functions vary on models or versions. Some functions may not be available on the vehicle's audio system.

If there is a problem, you may see an error message on the audio/information screen.

iPod/USB Flash Drive P. 350

How to Select a Play Mode

You can select repeat and shuffle modes when playing a song.

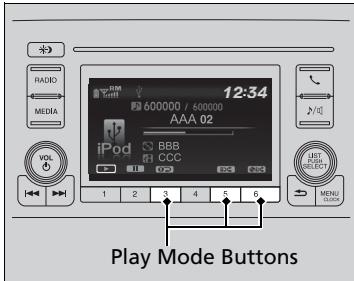

Available mode icons appear above the play mode buttons.

Press the button corresponding to the mode you want to select.

To turn off a play mode

Press the selected button.

How to Select a Play Mode

Play Mode Menu Items



 **Shuffle albums:** Plays all available albums in a selected category (playlists, artists, albums, songs, genres, or composers) in random order.



 **Random all:** Plays all available songs in a selected category (playlists, artists, albums, songs, genres, or composers) in random order.

 **Repeat one track:** Repeats the current song.

You can also select a play mode by pressing the **MENU/CLOCK** button.

Rotate  to select **Play mode**, then press .

Rotate  to select a mode, then press .

To turn it off, rotate  to select **Normal play**, then press .

Playing a USB Flash Drive

Your audio system reads and plays sound files on a USB flash drive in either MP3, WMA or AAC*1 format.

Connect your USB flash drive to the USB port, then press the **MEDIA** button.

➤ **USB Port(s)** P. 253

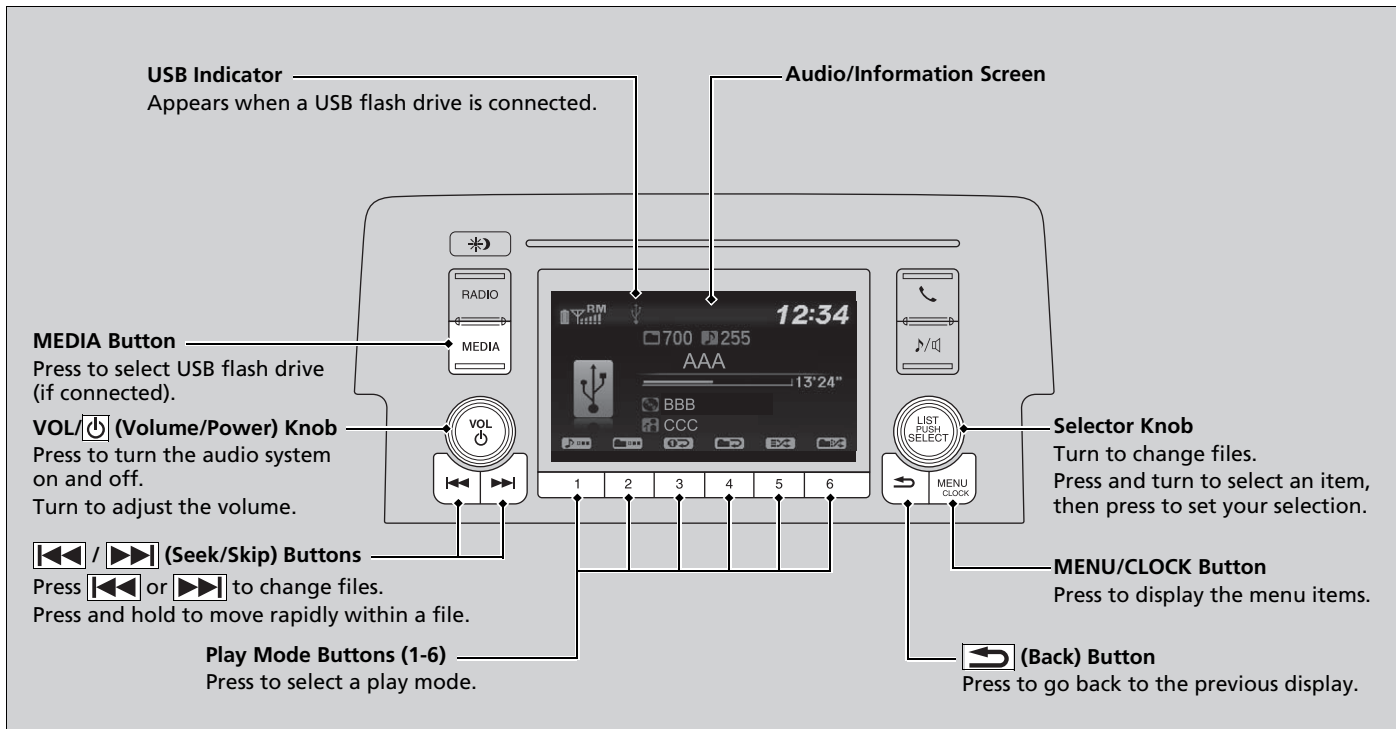

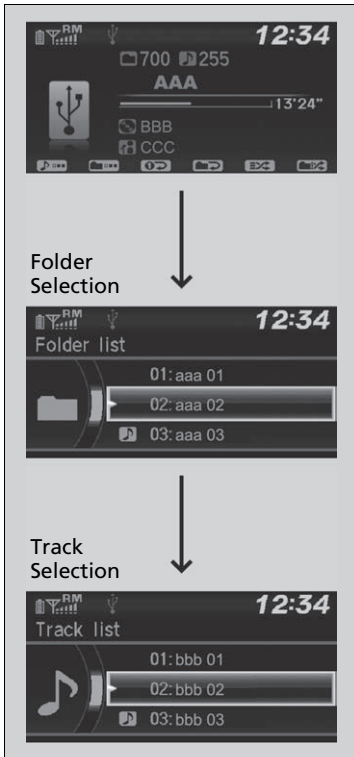

*1: Only AAC format files recorded with iTunes are playable on this unit.

How to Select a File from a Folder with the Selector Knob



1. Press  to display a folder list.

2. Rotate  to select a folder.

3. Press  to display a list of files in that folder.

4. Rotate  to select a file, then press .

▶▶ Playing a USB Flash Drive

Use the recommended USB flash drives.

▶ **General Information on the Audio System**
P. 353

Files in WMA format protected by digital rights management (DRM) cannot be played.

The audio system displays **Unplayable file**, and then skips to the next file.

If there is a problem, you may see an error message on the audio/information screen.

▶ **iPod/USB Flash Drive** P. 350

■ How to Select a Play Mode

You can select repeat, random, and scan modes when playing a file.

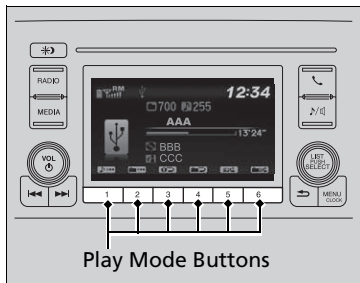

Available mode icons appear above the play mode buttons.

Press the button corresponding to the mode you want to select.

■ To turn off a play mode

Press the selected button.

▶▶ How to Select a Play Mode

Play Mode Menu Items

Repeat

 **Repeat one folder:** Repeats all files in the current folder.

 **Repeat one track:** Repeats the current file.

Random

 **Random in folder:** Plays all files in the current folder in random order.

 **Random all:** Plays all files in random order.



Scan



 **Scan folders:** Provides 10-second sampling of the first file in each of the main folders.

 **Scan tracks:** Provides 10-second sampling of all files in the current folder.

You can also select a play mode by pressing the **MENU/CLOCK** button.

Rotate  to select **Play mode**, then press .

Rotate  to select a mode, then press .

To turn it off, rotate  to select **Normal play**, then press .

Playing *Bluetooth*® Audio

Your audio system allows you to listen to music from your *Bluetooth*-compatible phone.

This function is available when the phone is paired and connected to the vehicle's Hands-Free Telephone (HFT) system.

☑ **Phone Setup** P. 400

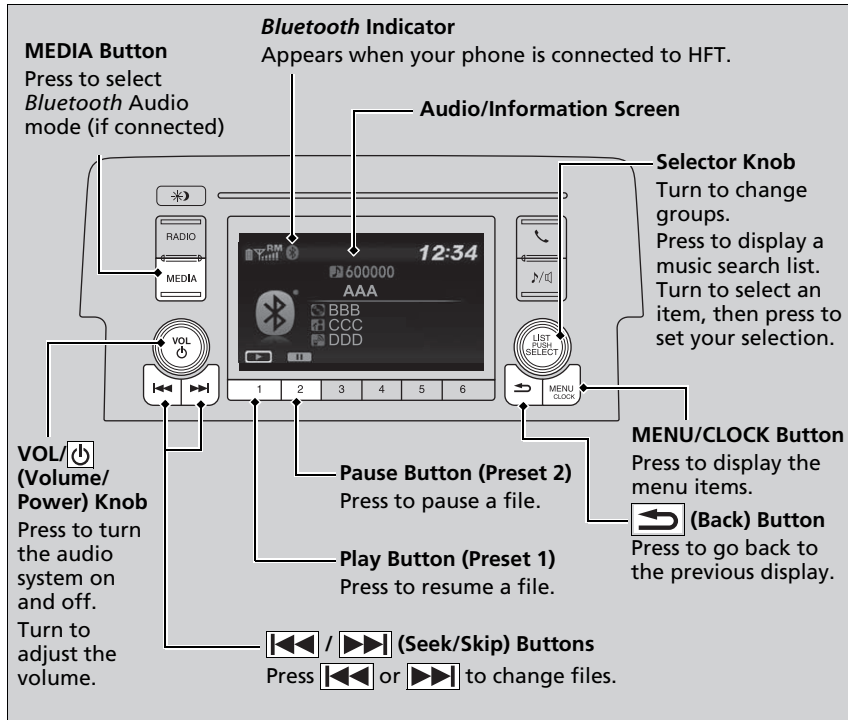

▶▶ Playing *Bluetooth*® Audio

Not all *Bluetooth*-enabled phones with streaming audio capabilities are compatible with the system. To check if your phone is compatible, ask a dealer.

Only one phone can be used with HFT at a time. When there are more than two paired phones in the vehicle, the first paired phone the system finds is automatically connected.

If more than one phone is paired to the HFT system, there will be a delay before the system begins to play.

In some cases, the name of the artist, album, or track may not appear correctly.

Some functions may not be available on some devices.

■ To Play *Bluetooth*® Audio Files

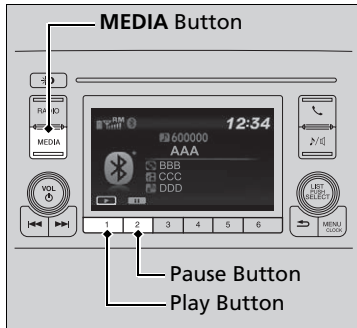

1. Make sure that your phone is paired and connected to HFT.
2. Press the **MEDIA** button until the *Bluetooth*® Audio mode is selected.

If the phone is not recognized, another HFT-compatible phone, which is not compatible for *Bluetooth*® Audio, may already be connected.

■ To pause or resume a file

Press the **Play** or **Pause** button to select a mode.

▶▶ To Play *Bluetooth*® Audio Files

To play the audio files, you may need to operate your phone. If so, follow the phone maker's operating instructions.

The pause function may not be available on some phones.

If any audio device is connected to the USB port, you may need to press the **MEDIA** button repeatedly to select the *Bluetooth*® Audio system.

Switching to another mode pauses the music playing from your phone.

How to Select a Song from the Music Search List with the Selector Knob

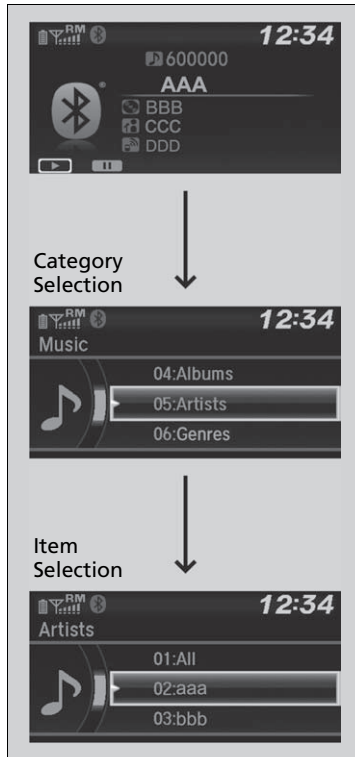



1. Press to display the music search list.
2. Rotate to select a category.
3. Press to display a list of items in the category.
4. Rotate to select an item, then press .
 - ▶ Press and rotate repeatedly until a desired item you want to listen is displayed.

How to Select a Song from the Music Search List with the Selector Knob

Depending on the *Bluetooth*® device you connect, some or all of the categories may not be displayed.

Models with Display Audio

To use the audio system function, the ignition switch must be in ACCESSORY  or ON *1.

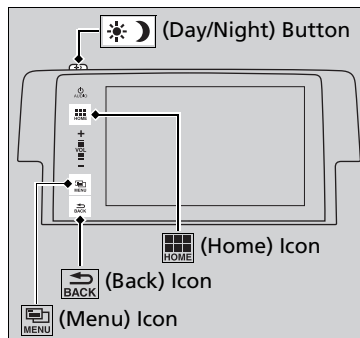



 (Home): Select to go to the home screen.

➤ **Switching the Display** P. 287

 (Menu): Select to display available options including **Sound**, **View Radio Text***2, **Music Search**, and playback modes.

 (Back): Select to go back to the previous screen when the icon is illuminated.

 (Day/Night) **button**: Press to change the audio/information screen brightness.

Press the  button once and select  or  to make an adjustment.

- ▶ Each time you press the  button, the mode switches among the daytime mode, nighttime mode and off mode.

➤ Audio System Basic Operation

Audio Menu Items

➤ **Station List** P. 316, 317

➤ **Music Search List** P. 322, 330

➤ **Scan** P. 317, 331

➤ **Play Mode** P. 323, 331

*1: Models with the keyless access system have an **ENGINE START/STOP** button instead of an ignition switch.

*2: Displayed only when text information has been received.

Audio/Information Screen

Displays the audio status and wallpaper. From this display, you can go to various setup options.

Switching the Display

Using the (display/information) button

Press the  (display/information) button to change the display.

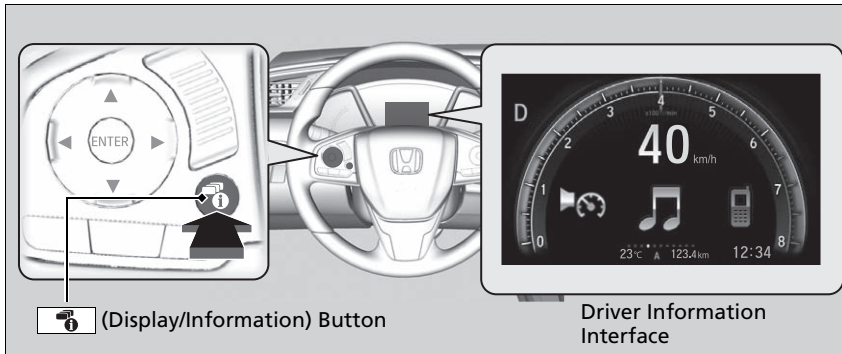



Using the (display/information) button

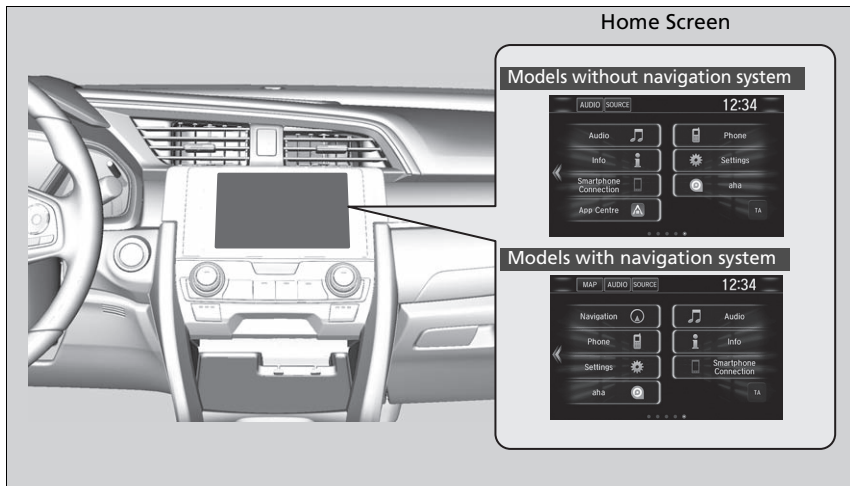

You can edit, add, and delete the contents shown on the driver information interface.

Customizing the Meter P. 291

■ Using the audio/information screen



Select  to go to the home screen.

Select **Phone**, **Info**, **Audio**, **Settings**, **Navigation***, **App Centre***, **aha***, **Smartphone Connection (Apple CarPlay, Android Auto)**, **TA**, **App List*** /  (APPS icon)*, or **Instrument Panel** ().

■ Phone

Displays the HFT information.

➤ **Hands-Free Telephone System** P. 415

▶▶ Using the audio/information screen

Touchscreen operation

- Use simple gestures - including touching, swiping and scrolling - to operate certain audio functions.
- Some items may be grayed out during driving to reduce the potential for distraction.
- You can select them when the vehicle is stopped or use voice commands*.
- Wearing gloves may limit or prevent touchscreen response.

You can change the touchscreen sensitivity setting.

➤ **Customized Features** P. 359

■ Info

Displays **Trip Computer** or **Clock/wallpaper**. Select  on the **Info Menu** screen to see all available options: **Trip Computer**, **Voice info***, **Clock/wallpaper** and **System/Device Information**.

Trip Computer:

- **Current Drive** tab: Displays the current trip information.
- **History of Trip A** tab: Displays information for the three previous drives. The information is stored every time you reset Trip A.
To delete the history manually, select **Delete history** on the **History of Trip A** tab. The confirmation message appears on the screen, then select **Yes**.

Voice info*: Displays a list of all voice commands.

Clock/wallpaper: Displays the clock and wallpaper.

System/Device Information:

- **System Info**: Displays the software version of the audio system.
- **USB info**: Displays the memory usage of the USB device.

■ Audio

Displays the current audio information.

■ Settings

Enters the customizing menu screen.

- **Customized Features** P. 359

■ Navigation*

Displays the navigation screen.

- **Refer to the Navigation System Manual**

* Not available on all models

■ App Centre*

Connects with your smartphone*¹ to play personalised music, information, and social media streams.

➤ **On Board Apps*** P. 336

■ aha*

Displays the Aha™ screen.

➤ **Playing Aha™*** P. 328

■ Smartphone Connection

Displays the Apple CarPlay or Android Auto.

➤ **Apple CarPlay** P. 343

➤ **Android Auto** P. 346

■ TA

Turns on and off the traffic information.

■ App List

Adds or removes apps or widgets on the home screen.

➤ **Home Screen** P. 297

■ Instrument Panel

Selects from three customizable settings for the driver information interface.

*1: Available on specific phones only. Ask a dealer for compatible phones for feature details.

* Not available on all models

Changing the Home Screen Icon Layout



1. Select .
2. Select and hold an icon.
 - ▶ The screen switches to the customization screen.
3. Drag and drop the icon to where you want it to be.
4. Select **OK**.
 - ▶ The screen will return to the home screen.

Customizing the Meter

You can edit, add, or delete the meter contents on the driver information interface.

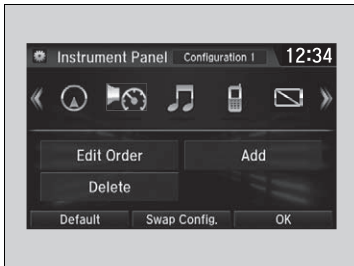

1. .
2. **Settings**
3. **System**
4. **Configuration of Instrument Panel**

Customizing the Meter

You can store up to three customized configurations. To select or customize a configuration, select **Swap Config.**

When you select **Swap Config.** during customization, the settings you changed will be saved.

When you select  during customization, the settings you changed will not be saved and you will be returned to the **Configuration of Instrument Panel** screen.

■ Editing order

To change the order of the icons on the driver information interface, first select:

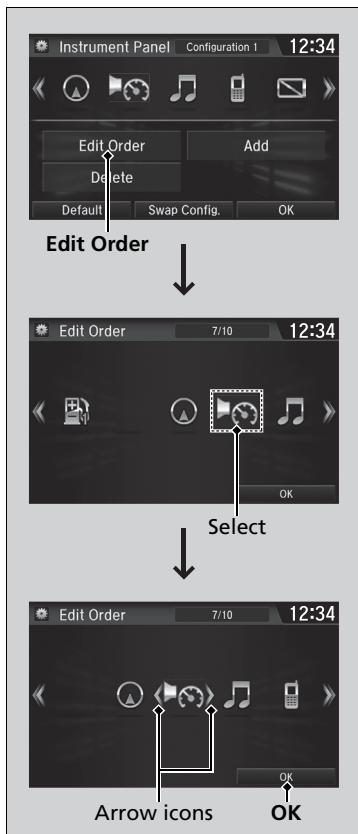

1. Edit Order

2. Select the icon you want to move.

- ▶ You will see arrows on both sides of the selected icon.

3. Select the left or right arrow repeatedly to move the icon to your desired position.

4. Select **OK**.

- ▶ The screen will return to the **Configuration of Instrument Panel** screen.

▶▶ Editing order

You can use an alternative method to change the order of the icons. First select:

1. **Edit Order**

2. Select and hold the icon you want to move.
3. Drag and drop the icon to where you want it to be.
4. Select **OK**.

- ▶ The screen will return to the **Configuration of Instrument Panel** screen.

■ Adding contents

You can add up to 10 contents on the driver information interface. To add contents, first select:

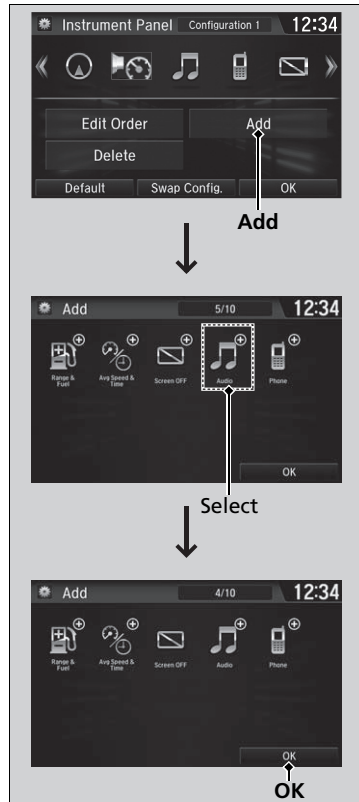

1. Add

2. Select an icon you want to add.

- ▶ You will see a plus mark on the upper right hand corner of the selected icon.

3. Select **OK**.

- ▶ The screen will return to the **Configuration of Instrument Panel** screen.

▶▶ Adding contents

Icons that are grayed out cannot be selected.

If an icon has a plus mark in the upper-right corner, it means that the icon has already been added.

■ Deleting contents

To delete contents on the driver information interface, first select:

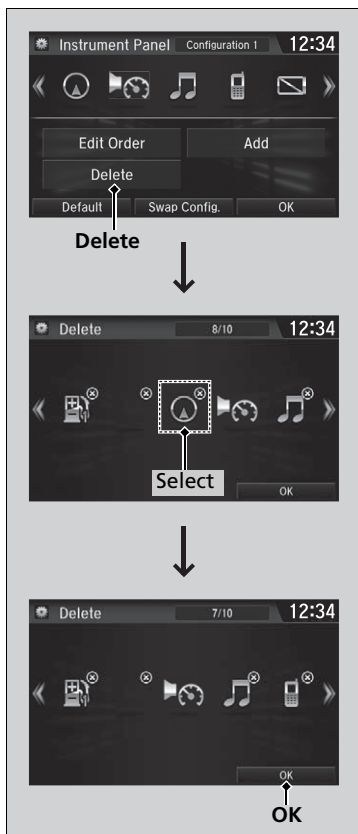

1. Delete

2. Select an icon you want to delete.

- ▶ The icon with an X on the upper right hand corner can be deleted.

3. Select **OK**.

- ▶ The screen will return to the **Configuration of Instrument Panel** screen.

▶▶ Deleting contents

You can also delete contents by selecting:

1. **Delete** or **Edit Order**

2. Select and hold an icon you want to delete.
3. Drag and drop the icon to the trash icon.
4. Select **OK**.

- ▶ The screen will return to the **Configuration of Instrument Panel** screen.

Wallpaper Setup

You can change, store, and delete the wallpaper on the audio/information screen.

Import wallpaper

You can import up to five images, one at a time, for wallpaper from a USB flash drive.

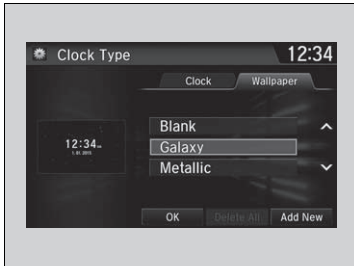

1. Connect the USB flash drive to the USB port.
 ▶ **USB Port(s)** P. 253
2. Select **Settings**.
3. Select **Clock**.
4. Select **Clock/Wallpaper Type**, then open the **Wallpaper** tab.
5. Select **Add New**.
 ▶ The picture name is displayed on the list.
6. Select a desired picture.
 ▶ The preview is displayed on the left side on the screen.
7. Select **Start Import** to save the data.
 ▶ The display will return to the wallpaper list.





Wallpaper Setup

The wallpaper you set up on **Clock/Wallpaper Type** cannot be displayed on the driver information interface.

- When importing wallpaper files, the image must be in the USB flash drive's root directory. Images in a folder cannot be imported.
- The file name must be fewer than 64 characters.
- The file format of the image that can be imported is BMP (bmp) or JPEG (jpg).
- The individual file size limit is 5 MB.
- The maximum image size is 4,096 × 4,096 pixels. If the image size is less than 800 × 480 pixels, the image is displayed in the middle of the screen with the extra area appearing in black.
- If the USB flash drive does not have any pictures, the **No files detected.** message appears.



After changing the screen interface design, you can change the wallpaper by following procedure.

1. Select .
2. Select .
3. Select and hold empty space on the home screen. The pop-up menu appears on the screen.
4. Select **Change wallpaper**.
5. Select **Gallery**, **Live wallpapers**, or **Wallpapers**.

■ Select wallpaper

1. Select **Settings**.
2. Select **Clock**.
3. Select **Clock/Wallpaper Type**, then open the **Wallpaper** tab.
 - ▶ The screen changes to the wallpaper list.
4. Select a desired wallpaper.
 - ▶ The preview is displayed on the left side on the screen.
 - ▶ The pop-up menu appears on the screen.
5. Select **Set**.
 - ▶ The display will return to the wallpaper list.

■ To view wallpaper once it is set

1. Select .
2. Select **Info**.
3. Select .
4. Select **Clock/wallpaper**.

■ Delete wallpaper

1. Select **Settings**.
2. Select **Clock**.
3. Select **Clock/Wallpaper Type**, then open the **Wallpaper** tab.
 - ▶ The screen changes to the wallpaper list.
4. Select a wallpaper that you want to delete.
 - ▶ The preview is displayed on the left side on the screen.
 - ▶ The pop-up menu appears on the screen.
5. Select **Delete**.
 - ▶ A confirmation message appears on the screen.
6. Select **Yes** to delete completely.
 - ▶ The display will return to the wallpaper list.

▶▶ Wallpaper Setup

From the pop-up menu, select **Preview** to see a preview at full-size screen.

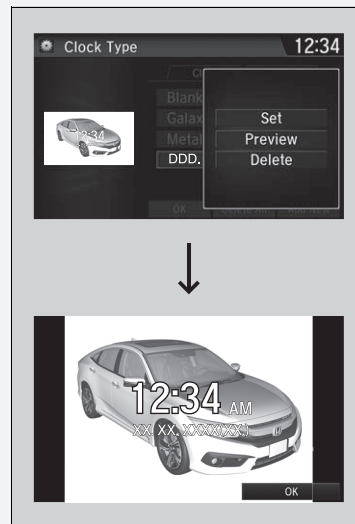

To go back to the previous screen, select **OK**, or select .



When the file size is large, it takes a while to be previewed.

To delete all wallpapers you add, select **Delete All**, then **Yes**.

Home Screen

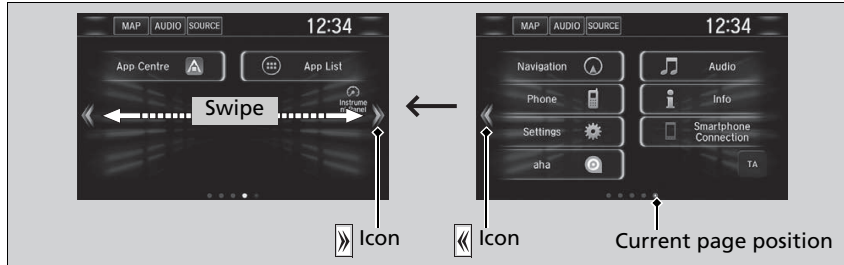
To change to a next screen



Selecting  or , or swiping the screen left or right changes to the next screen.



Home Screen

The home screen has 5 pages (fixed). You cannot add any more pages.



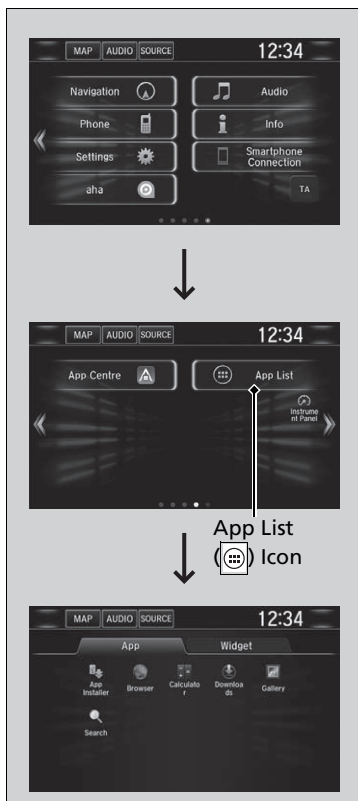



Select  to go directly back to the first page of the home screen from any page.

■ To use apps or widgets



1. Select .
2. Select .
3. Select **App List** .
 - ▶ The apps screen appears.
4. Select the app or widget you want to use.

Preinstall app list:

-  (Browser): Displays the web browser utilized by smartphone and Wi-Fi connection.
-  (Calculator): Displays Calculator.
-  (Gallery): Displays images.
-  (Downloads): Displays the data downloaded from the web browser and so on.
-  (App installer): Allows you to install apps.
-  (Search): Displays various retrieval screen.

▶▶ To use apps or widgets

Israeli, Turkish, and except Middle Eastern models

You need to select  to add or widget icons to the home screen.

Select and hold a selected app or widget to add that app's or widget's shortcut on the home screen.

Pre-installed apps may not start up normally. If this occurs, you need to reset the system.

 **Defaulting All the Settings** P. 393

If you perform **Factory Data Reset**, it may reset all the settings to their factory default.

 **Defaulting All the Settings** P. 393

In case those apps still do not startup normally even after **Factory Data Reset**, contact your dealer.

There is a possibility that a browser is shut down in the situation of the use. In that situation, the screen will return to before the browser startup.

You can delete user installed apps by the following procedure.

1. Select .
2. Select **Settings**.
3. Select **System**.
4. Select the **Others** tab.
5. Select **Detailed Information**.
6. Select an App that you want to delete.
7. Select **Delete**.

Pre-installed apps cannot be deleted.

■ To add app or widget icons on the home screen

App or widget icons can be added on the home screen.

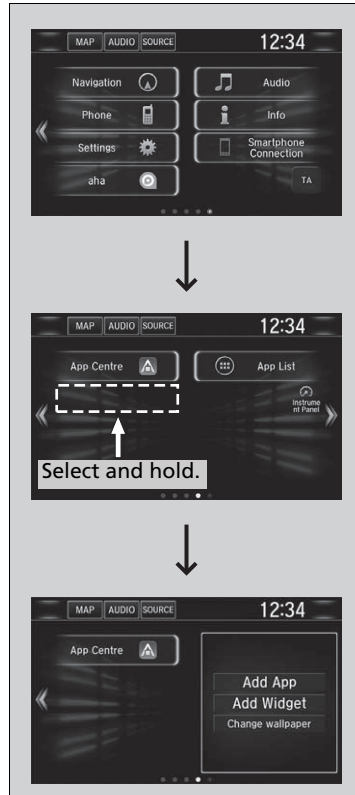

1. Select .
2. Select .
3. Select and hold empty space on the home screen.
 - ▶ The pop-up menu appears on the screen.
4. Select **Add App** or **Add Widget**.
 - ▶ The apps/widget screen appears.

▶▶ To add app or widget icons on the home screen

Israeli, Turkish, and except Middle Eastern models
 You need to select  to add or widget icons to the home screen.

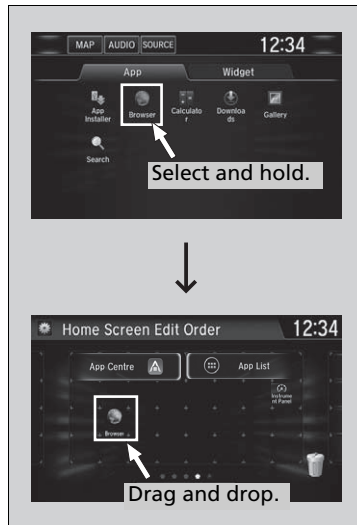

5. Select and hold an app or widget icon you want to add.
 - ▶ The screen switches to the customization screen.
6. Drag and drop the icon to where you want it to be.
7. Select **OK**.
 - ▶ The screen will return to the home screen.

■ To move icons on the home screen

You can change location on the home screen.

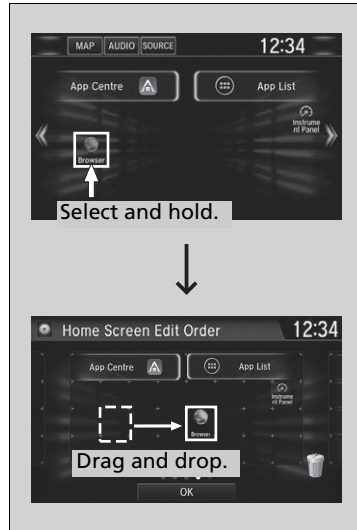

1. Select and hold an icon.
 - ▶ The screen switches to the customization screen.
2. Drag and drop the icon to where you want it to be.
3. Select **OK**.
 - ▶ The screen will return to the home screen.

☒ To move icons on the home screen

You can also move the **Phone**, **Info**, **Audio**, **Settings**, **Navigation***, **App Centre***, **aha***, **Smartphone Connection**, **TA**, **App List** (☒), and **Instrument Panel** (☒) icons in the same manner.

* Not available on all models

Continued

■ To remove icons on the home screen

You can delete the icons on the home screen.

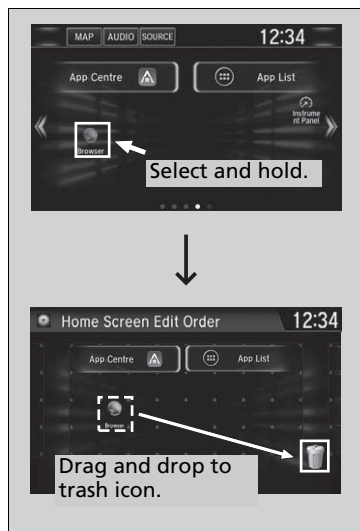

1. Select and hold an icon.
 - ▶ The screen switches to the customization screen.
2. Drag and drop the icon you want to remove to the trash icon.
 - ▶ The icon is removed from the home screen.
3. Select **OK**.
 - ▶ The screen will return to the home screen.

▶▶ To remove icons on the home screen

You cannot delete the **Phone**, **Info**, **Audio**, **Settings**, **Navigation**, **App Centre**, **aha**, **Smartphone Connection**, **TA**, **App List** (☰), and **Instrument Panel** (📻) icons.

Apps or widgets will not be deleted by deleting the icon on the home screen.

■ To change the home screen wallpaper

You can change a wallpaper of the home screen.

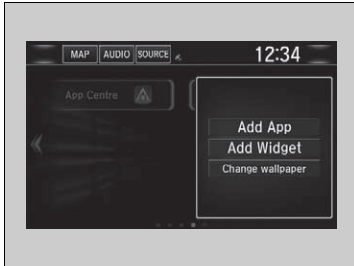

1. Select and hold empty space on the home screen.
 - ▶ The pop-up menu appears on the screen.
2. Select **Change wallpaper**.
 - ▶ The pop-up menu appears on the screen.



3. Select an app for selecting wallpapers.
4. Select the wallpaper you want to change.
5. Select **Set wallpaper**.
 - ▶ The wallpaper is changed, then the screen will return to the home screen.

Status Area



1. Swipe the upper area of the screen.
 - ▶ The status area appears.
2. Select an item to see the details.
3. Select  or swipe up the bottom bar to close the area.

Changing the Screen Interface



You can change the screen interface design.



1. Select .
2. Select **Settings**.
3. Select **System**.
4. Select the **Others** tab.
5. Select **Change Skin**.
6. A confirmation message appears on the screen. Select **Yes**.

Changing the Screen Interface

After changing the screen interface design, you can change the wallpaper by following procedure.

1. Select .
2. Select .
3. Select and hold empty space on the home screen.
The pop-up menu appears on the screen.
4. Select **Change wallpaper**.
5. Select **Gallery**, **Live wallpapers**, or **Wallpapers**.

If you change the screen interface, some of the setting items will change.

 **Customized Features** P. 359

Menu Customize

You can change menu icons on the right side of the **Audio**, **Phone**, and **Info** screen.

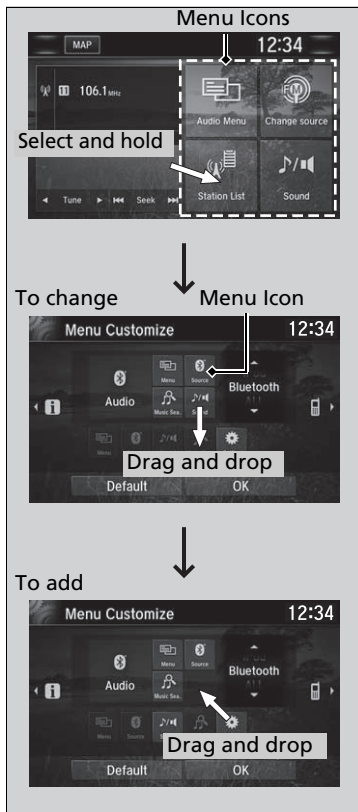

1. Select and hold menu icon.

2. Select ◀ or ▶ icon, then **Audio**, **Phone**, or **Info** from **Menu Customize**.

3. Select and hold the menu icon you want to change, then drag and drop the icon to the bottom.

4. Select and hold the menu icon you want to add, then drag and drop the icon above.

5. Select **OK**.

Menu Customize

You can also use the method below to change menu icon:

Select **Settings**→**System**→**Home tab**→**Menu Icon Position**

■ Closing Apps

You can close specific apps running in the background on the system.

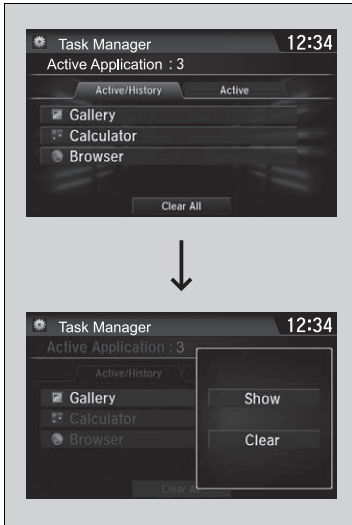

1. Select and hold .
2. Select the **Active** tab.
 - ▶ If you select the **Active/History** tab, you can close the apps that are currently running and delete the app activity history simultaneously.
3. Select an app you want to close.
4. Select **Clear**.
 - ▶ The display will return to the app list.

☒ Closing Apps

If you have a number of apps running in the background and something goes wrong with the audio system, some of those apps may not work properly. If this happens, close all the apps and re-launch the app/apps that you want to use.

To close all apps on the system, select **Clear All**, then **Yes**.

You cannot close the Aha™* and Garmin* apps.

* Not available on all models

Adjusting the Sound

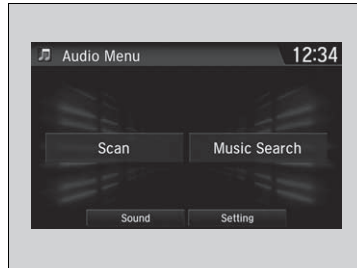

1. Select .
2. Select **Audio**.
3. Select .
4. Select **Sound**.

Select a tab from the following choices:

- **BAS-MID-TRE:** Bass, Middle, Treble
- **FAD-BAL*/FAD-BAL-SUBW*:** Fader, Balance, Subwoofer*
- **SVC*/SVC-Neural*:** Speed Volume Compensation, DTS Neural Sound™*

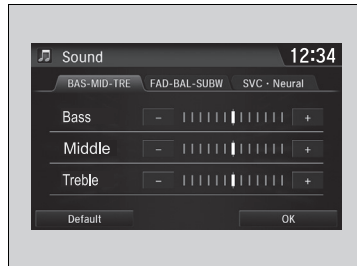

▶▶ Adjusting the Sound

The SVC has four modes: **Off**, **Low**, **Mid**, and **High**. SVC adjusts the volume level based on the vehicle speed. As you go faster, audio volume increases. As you slow down, audio volume decreases.

Display Setup

You can change the brightness or colour theme of the audio/information screen.

Changing the Screen Brightness

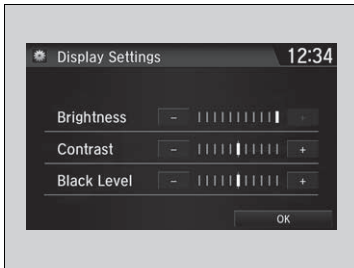

1. Select .
2. Select **Settings**.
3. Select **System**.
4. Select the **Display** tab.
5. Select **Display Settings**.
6. Select the setting you want.
7. Select **OK**.

Changing the Screen's Colour Theme



1. Select .
2. Select **Settings**.
3. Select **System**.
4. Select the **Display** tab.
5. Select **Background Colour**.
6. Select the setting you want.
7. Select **OK**.

Changing the Screen Brightness

You can change the **Contrast** and **Black Level** settings in the same manner.

■ Selecting an Audio Source

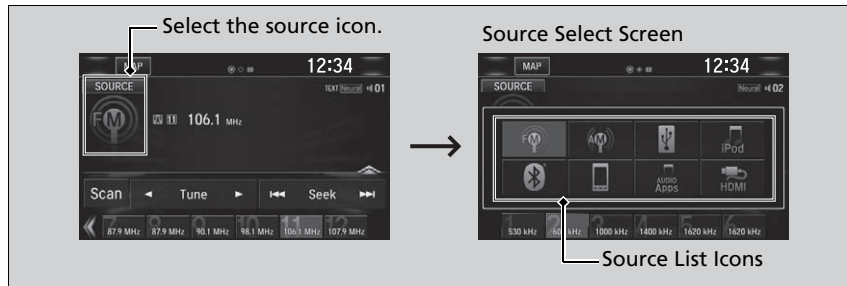

Select the current source icon, then select an icon on the source list to switch the audio source.

▶▶ Selecting an Audio Source

If you startup preinstalled audio apps, **AUDIO APPS** is displayed on the screen.

These preinstalled apps cannot be displayed on the source select screen.



You can startup those audio apps from **AUDIO APPS**.

When you are using the Aha™ screen and you want to select another source, select **AUDIO** on the upper left of the screen. The source select screen will appear. Select the source you want.

European models with navigation system

Voice Control Operation*¹

Your vehicle has a voice control system that allows hands-free operation.

The voice control system uses the  (Talk) and  (hang-up/back) buttons on the steering wheel and a microphone near the map lights in the ceiling.

Voice Recognition

To achieve optimum voice recognition when using the voice control system:



- Make sure the correct screen is displayed for the voice command that you are using.
- Close the windows and sunroof*.
- Adjust the dashboard and side vents so air does not blow onto the microphone in the ceiling.
- Speak clearly in a natural speaking voice without pausing between words.
- Reduce any background noise if possible. The system may misinterpret your command if more than one person is speaking at the same time.

*¹: Language that the voice control system recognizes are English, German, French, Spanish, and Italian.

* Not available on all models

Continued

☒ Voice Control Operation*¹

When you press the  button, a helpful prompt asks what you would like to do. Press and release the  button again to bypass this prompt and give a command.

☒ Voice Recognition

The voice control system can only be used from the driver's seat because the microphone unit removes noises from the front passenger's side.

■ Voice Portal Screen *

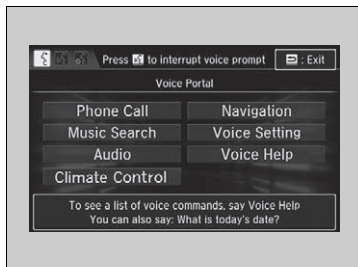

When the  (Talk) button is pressed, available voice commands appear on the screen.

For a complete list of commands, say "Voice Help" after the beep or select **Voice Help**.

You can see the list of commands in **Voice Info** on the **Info Menu** screen. Select **Info**, then select .

The system only recognizes the commands on the following pages, at certain screens. Free form voice commands are not recognized.

■ Phone Call

This can be only used when the phone is connected. When the system recognizes the *Phone call* command, the screen will change to the voice recognition screen for phone commands.

- *Dial by Number*
- *Call History*
- *Redial*
- *Call <Your Contact Name>*
- *Call <Phone Number>*

Phone Call commands are not available if using Apple CarPlay.

■ Music Search

This can be only used when the iPod or USB device is connected.

■ Climate Control

When the system recognizes the *Climate Control* command, the screen will change the dedicated screen to the climate control voice recognition screen.

➤ **Climate Control Commands** P. 314

■ Audio

When the system recognizes the *Audio* command, the screen will change to the audio voice recognition screen.

- *Audio On**1
- *Audio Off**1
- *Radio FM*
- *Radio MW*
- *Radio LW*
- *iPod*
- *USB*
- *Other Sources*

■ Navigation

The screen changes to the navigation screen.

➤ **Refer to the Navigation System Manual**

■ Voice Setting

The screen changes to the **Voice Recog.** tab on the **System Settings** screen.

*1: These commands toggle the function on and off, so the command may not match your intended action.

■ Voice Help

You can see a list of the available commands on the screen.

- *Useful Commands*
- *Phone Commands*
- *Audio Commands*
- *On Screen Commands*
- *Music Search Commands*
- *General Commands*
- *Climate Control Commands*

■ Useful Commands

The system accepts these commands on the voice portal top screen.

- *Call <Phone Number>*
- *Call <Your contact Name>*
- *What time is it?*
- *What is today's date?*

■ Phone Commands

The system accepts these commands on the dedicated screen for the voice recognition of the phone.

- *Call by number*
- *Call by name*
- *Call <Phone Number>*
- *Call <Your contact Name>*

■ Audio Commands

The system accepts these commands on the dedicated screen for the voice recognition of the audio.

■ Radio FM Commands

- *Radio tune to <87.5-108.0> FM*
- *Radio FM preset <1-12>*

■ Radio LW Commands

- *Radio tune to <153-279> LW*
- *Radio LW preset <1-6>*

■ Radio MW Commands

- *Radio tune to <531-1602> MW*
- *Radio MW preset <1-6>*

■ iPod Commands

- *iPod play*
- *iPod play track <1-30>*
- *Music Search*
- *What album is this?*
- *What am I listening to?*

■ USB Commands

- *USB play*
- *USB play track <1-30>*
- *Music Search*
- *What album is this?*
- *What am I listening to?*

■ DAB Commands

- *DAB preset <1-12>*

■ Bluetooth® audio Commands

- *Bluetooth® audio play*

NOTE:

Bluetooth® Audio commands may not work on some phones or *Bluetooth®* Audio devices.

■ HDMI™ Commands

- *HDMI Play*

■ On Screen Commands

When **On Screen Commands** is selected, the explanation screen is displayed.

■ Music Search Commands

The system accepts these commands on the **Music Search** screen.

■ Using Song By Voice

Song By Voice™ is a feature that allows you to select music from your iPod or USB device using Voice Commands. To activate this mode, you must press the  (Talk) button and say: "Music search".

■ Song By Voice Commands

- *What am I listening to?*
- *Who am I listening to?*
- *Who is this?*
- *What's playing?*
- *Who's playing?*
- *What album is this?*

■ Play Commands

- *Play artist <Name>*
- *Play track/song <Name>*
- *Play album <Name>*
- *Play genre/category <Name>*
- *Play playlist <Name>*
- *Play composer <Name>*

■ List Commands

- *List artist <Name>*
- *List album <Name>*
- *List genre/category <Name>*
- *List playlist <Name>*
- *List composer <Name>*

■ General Commands

- *What time is it?*
- *What is today's date?*

■ Climate Control Commands

- *Climate control on*1*
- *Climate control off*1*
- *Fan speed <1-7>*
- *Temperature max heat*
- *Temperature max cool*
- *Temperature <18-32> degrees*
- *Defrost On*1*
- *Defrost Off*1*
- *Air Conditioner On*1*
- *Air Conditioner Off*1*
- *More*
- *Vent*
- *Dash and floor*
- *Fan speed up*
- *Fan speed down*
- *Floor vents*
- *Floor and Defrost*
- *Temperature up*
- *Temperature down*

*1: These commands toggle the function on and off, so the command may not match your intended action.

Playing AM/FM Radio

Driver Information Interface

Audio/Information Screen

Power/Audio (Power/Audio) Icon
Select to turn the audio system on and off.

VOL (Volume) Icons
Select to adjust the volume.

(Menu) Icon
Select to display the menu items.

(Back) Icon
Select to go back to the previous display.

Scan Icon
Select to scan each station with a strong signal.

Tune Icons
Select ◀ or ▶ to tune the radio frequency.

Open/Close Icon^{*1}
Displays/hides the detailed information.

Seek Icons
Select ▶▶ or ◀◀ to search the selected band up or down for a station with a strong signal.

Preset Icons
Tune the preset radio frequency. Select and hold the preset icon to store that station. Select >> to display preset 7 onwards.

*1: Some or all of the lists may not be displayed.

■ Preset Memory

To store a station:

1. Tune to the selected station.
2. Select and hold the preset number for the station you want to store.

You can also store a preset station by the following procedure.

1. Tune to the selected station.
2. Select the open/close icon to display a list.
3. Select the **Preset** tab.
4. Select and hold the preset number for the station you want to store.

■ Station List

Lists the strongest stations on the selected band.

1. Select the open/close icon to display a list.
2. Select the **Station List** tab.
3. Select the station.

■ Manual update

Updates your available station list at any time.

1. Select the open/close icon to display a list.
2. Select the **Station List** tab.
3. Select **Refresh**.

▶▶ Preset Memory

The **ST** indicator appears on the display indicating stereo FM broadcasts.

Stereo reproduction in AM is not available.

Switching the Audio Mode

Press the ▲ or ▼ button on the steering wheel or select **SOURCE** on the screen.

▶▶ **Audio Remote Controls** P. 257

Middle Eastern except Israeli and Turkish models

You can store 6 AM stations and 12 FM stations into preset memory.

Israeli, Turkish, and except Middle Eastern models

You can store 12 AM stations and 12 FM stations into preset memory. AM has two types of frequencies LW and MW, and each lets you store six stations.

■ Scan

Samples each of the strongest stations on the selected band for 10 seconds. To turn off scan, select **Cancel** or .

■ Radio Data System (RDS)*

Provides text data information related to your selected RDS-capable FM station.

■ To find an RDS station from Station List

1. Select the open/close icon to display a list while listening to an FM station.
2. Select the **Station List** tab.
3. Select the station.

■ Manual update

Updates your available station list at any time.

1. Select the open/close icon to display a list while listening to an FM station.
2. Select the **Station List** tab.
3. Select **Refresh**.

■ Radio text

Displays the radio text information of the selected RDS station.

1. Select .
2. Select **View Radio Text**.

■ Scan

Samples each of the strongest stations on the selected band for 10 seconds.

To turn off scan, select **Cancel** or .

* Not available on all models

⌘ Radio Data System (RDS)*

When you select an RDS-capable FM station, the RDS automatically turns on, and the frequency display changes to the station name. However, when the signals of that station become weak, the display changes from the station name to the frequency.

Playing DAB (Digital Audio Broadcasting)*

The diagram illustrates the interaction between the Driver Information Interface (DAB) and the Audio/Information Screen. The DAB screen shows a speedometer with '40 km/h' and a DAB station 'BBBBB'. The Audio/Information Screen shows a 'MAP' view with 'SOURCE' 'AAAAA', 'BBBBB', and 'CCCCC', and a 'Scan' button. A vertical sidebar contains icons for AUDIO, HOME, VOL, MENU, and BACK. A bottom control bar contains 'Scan', 'Ensemble', and 'Service' buttons with various preset icons.

Driver Information Interface

Audio/Information Screen

Power/Audio Icon
Select to turn the audio system on and off.

VOL (Volume) Icons
Select to adjust the volume.

(Menu) Icon
Select to display the menu items.

(Back) Icon
Select to go back to the previous display.

Scan Icon
Select to scan each receivable ensemble or service.

Ensemble Icons
Select or to tune the ensemble.
Select and hold or to search the selected service up to down for an ensemble until an receivable ensemble is found.

Open/Close Icon^{*1}
Displays/hides the detailed information.

Service Icons
Select or to tune the service component.

Preset Icons
Tune the preset frequency. Select and hold the preset icon to store that station. Select to display preset 7 onwards.

*1:Some or all of the lists may not be displayed.

■ Preset Memory

To store a service:

1. Tune to the selected service.
2. Select and hold the preset number for the service you want to store.

You can also store a preset service by the following procedure.

1. Tune to the selected service.
2. Select the open/close icon to display a list.
3. Select the **Preset** tab.
4. Select and hold the preset number for the service you want to store.

■ Ensemble List

Lists the receivable ensembles on the selected service.

1. Select the open/close icon to display a list.
2. Select the **Ensemble List** tab.
3. Select the ensemble.

■ Manual update

Updates your available ensemble list at any time.

1. Select the open/close icon to display a list.
2. Select the **Ensemble List** tab.
3. Select **Update List**.

☒ Preset Memory

Switching the Audio Mode

Press the ▲ or ▼ button on the steering wheel or select **SOURCE** on the screen.

☒ **Audio Remote Controls** P. 257

You can store 12 DAB stations into preset memory.

■ Scan

Samples each of the receivable ensemble or service on the selected service for 10 seconds.

1. Select **Scan**.
2. Select **Scan Ensemble** or **Scan Service**.

To turn off scan, select **Cancel Scan**.

■ Radio text

Displays the radio text information of the selected DAB station.

1. Select .
2. Select **View Radio Text**.

Playing an iPod

Connect the iPod using your USB connector to the USB port, then select the iPod mode.

➤ **USB Port(s)** P. 253

Driver Information Interface

Audio/Information Screen

Open/Close Icon*
Displays/hides the detailed information.

Song Icons
Select **⏮** or **⏭** to change songs. Select and hold to move rapidly within a song.

Play/Pause Icon

Power/Audio (Power/Audio) Icon
Select to turn the audio system on and off.

VOL (Volume) Icons
Select to adjust the volume.

(Menu) Icon
Select to display the menu items.

(Back) Icon
Select to go back to the previous display.

Cover Art

*1: Some or all of the lists may not be displayed.

■ How to Select a Song from the Music Search List

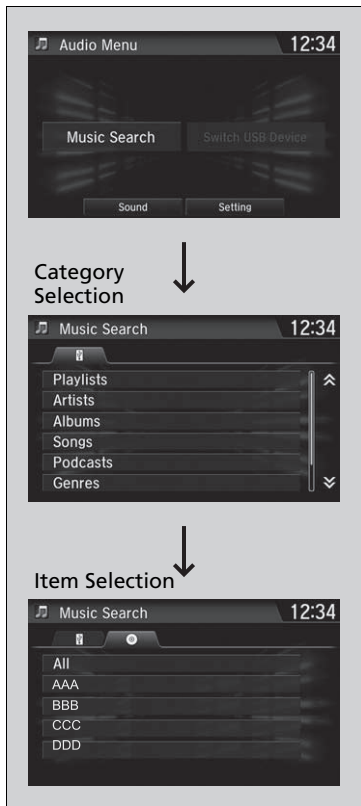

1. Select  and select **Music Search**.

2. Select the items on that menu.

▶▶ Playing an iPod

Available operating functions vary on models or versions. Some functions may not be available on the vehicle's audio system.

If there is a problem, you may see an error message on the audio/information screen.

 **iPod/USB Flash Drive** P. 350

If you operate any music app on your iPhone/iPod while the phone is connected to the audio system, you may no longer be able to operate the same app on the audio/information screen. Reconnect the device if necessary.

If an iPhone is connected via Apple CarPlay, the iPod/USB source is unavailable and audio files on the phone can only be played within Apple CarPlay.

How to Select a Play Mode

You can select shuffle and repeat modes when playing a file.
Select a play mode.

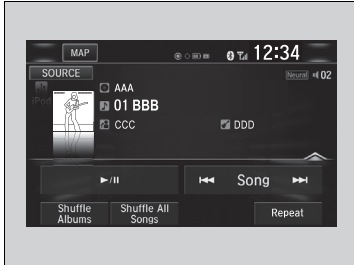

■ To turn off a play mode

Select the mode you want to turn off.

How to Select a Play Mode

Play Mode Menu Items

Shuffle All Songs: Plays all available files in a selected list (playlists, artists, albums, songs, podcasts, genres, composers, or audiobooks) in random order.

Shuffle Albums: Plays all available albums in a selected list (playlists, artists, albums, songs, podcasts, genres, composers, or audiobooks) in random order.

Repeat: Repeats the current track.

Song By Voice™ (SBV)*

Use SBV to search for and play music from your USB flash drive or iPod using voice commands.

■ To enable SBV

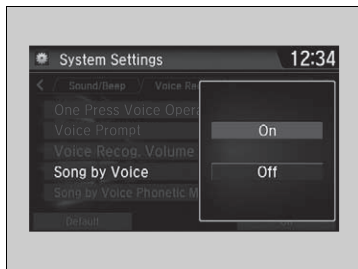

1. Select .
2. Select **Settings**.
3. Select **System**.
4. Select the **Voice Recog.** tab.
5. Select **Song by Voice**.
6. Select **On** or **Off**.



⌘ Song By Voice™ (SBV)*

Setting options:

- **On** (factory default): Song By Voice™ commands are available.
- **Off**: Disable the feature.

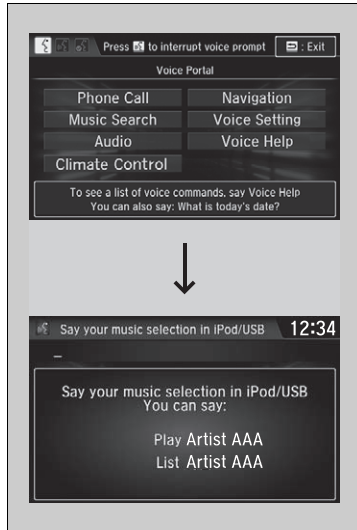
■ Searching for music using SBV



1. Set the **Song by Voice** setting to **On**.
2. Press the  (Talk) button and say “*Music Search*” to activate the SBV feature for the USB flash drive and iPod.
3. Then, say a next command.
 - ▶ Example 1: Say “*(List) ‘Artist A’*” to view a list of songs by that artist. Select the desired song to start playing.
 - ▶ Example 2: Say “*(Play) ‘Artist A’*” to start playing songs by that artist.
4. To cancel SBV, press the  (hang-up/back) button on the steering wheel. The selected song continues playing.

Once you have cancelled this mode, you need to press the  button and say “*Music Search*” again to re-activate this mode.

☒ Searching for music using SBV

Song By Voice™ Commands List

▶ **Song By Voice Commands** P. 314

NOTE:

Song By Voice™ commands are available for tracks stored on the USB flash drive or iPod.

You can add phonetic modifications of difficult words so that it is easier for SBV to recognize artists, songs, albums, and composers in voice commands.

▶ **Phonetic Modification** P. 326

SBV is not available when using Apple CarPlay. Use Siri Eyes Free instead.

Continued

■ Phonetic Modification

Add phonetic modifications of difficult or foreign words so that it is easier for SBV to recognize artists, songs, albums, and composers in voice commands when searching for music on the USB flash drive or iPod.

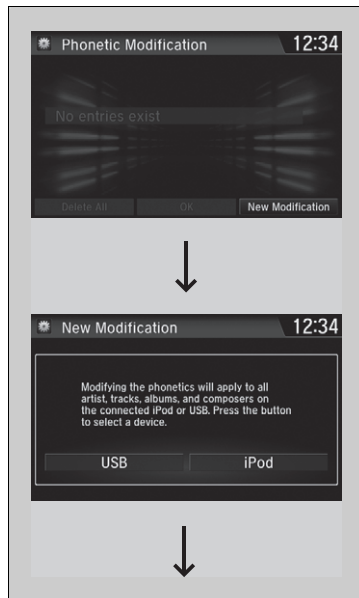



1. Select .
2. Select **Settings**.
3. Select **System**.
4. Select the **Voice Recog.** tab.
5. Select **Song by Voice Phonetic Modification**.
6. Select **New Modification**.
7. Select **USB** or **iPod**.

▶▶ Phonetic Modification

Song by Voice Phonetic Modification function is not available when **Song by Voice** is set to **Off**.

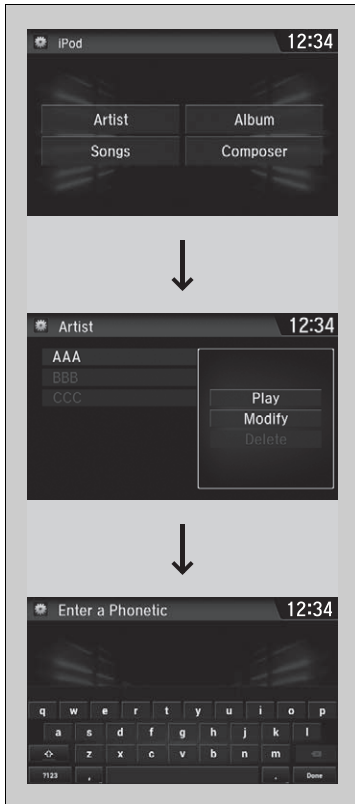
You can store up to 2,000 phonetic modification items.



8. Select the item to modify (e.g., **Artist**).
 - ▶ The list of the selected item appears on the screen.
9. Select an entry to modify.
 - ▶ The pop-up menu appears on the screen.
 - ▶ To listen to the current phonetic modification, select **Play**.
 - ▶ To delete the current phonetic modification, select **Delete**.
10. Select **Modify**.
11. Select the phonetic spelling you want to use (e.g., "Artist A") when prompted.
12. Select **OK**.
 - ▶ The artist "No Name" is phonetically modified to "Artist A." When in the SBV mode, you can press the  (Talk) button and use the voice command "Play 'Artist A'" to play songs by the artist "No Name."

Playing Aha™*

Aha™ can be displayed and operated on the audio/information screen when your smartphone is connected to the audio system by Wi-Fi.

▶ **Wi-Fi Connection** P. 340

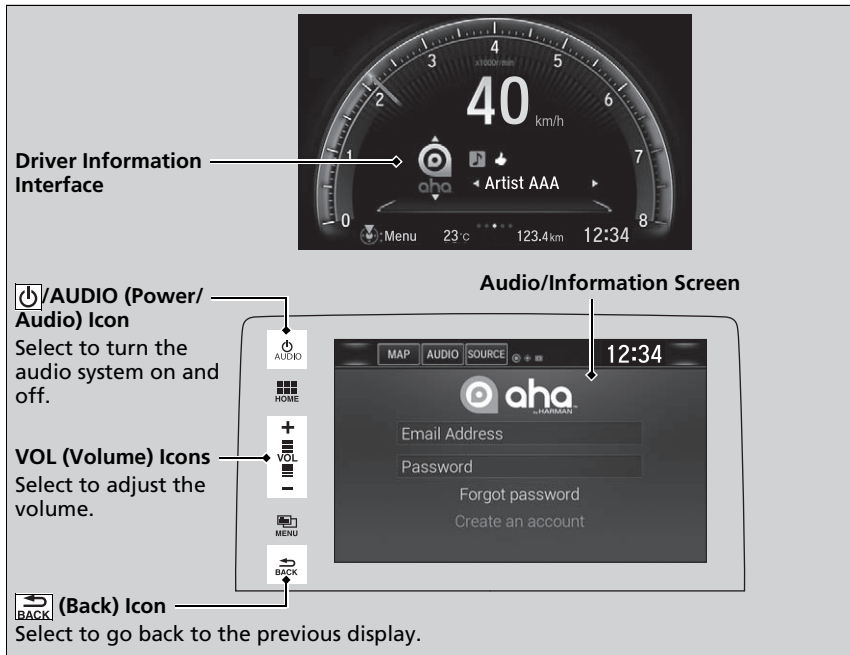

▶▶ Playing Aha™*

Aha™ by Harman is a cloud-based service that organizes your favorite web content into live radio stations. You can access podcasts, internet radio, location-based services, and audio updates from social media sites.

Available operating functions vary on software versions. Some functions may not be available on the vehicle's audio system.

The menu items vary depending on the station you selected.

You must have a previously set up Aha™ account prior to using the service in your vehicle. Visit www.aharadio.com for more information.

You want to select another source, select **AUDIO** on the upper left of the screen. The source select screen will appear. Select the source you want.

If there is an active connection to Apple CarPlay or Android Auto, Aha™ can only be accessed when the phone is connected through Wi-Fi.

Playing a USB Flash Drive

Your audio system reads and plays sound and videos files on a USB flash drive in either MP3, WMA, AAC*1, WAV, or MP4 format.

Connect your USB flash drive to the USB port, then select the USB mode.

📌 **USB Port(s)** P. 253

Driver Information Interface

AUDIO (Power/Audio) Icon
Select to turn the audio system on and off.

VOL (Volume) Icons
Select to adjust the volume.

(Menu) Icon
Select to display the menu items.

(Back) Icon
Select to go back to the previous display.

Folder Icons
Select ▶ to skip to the next folder, and ◀ to skip to the beginning of the previous folder.

Audio/Information Screen

Open/Close Icon*2
Displays/hides the detailed information.

Track Icons
Select ◀◀ or ▶▶ to change files. Select and hold to move rapidly within a track.

*1: Only AAC format files recorded with iTunes are playable on this unit.

*2: Some or all of the lists may not be displayed.

How to Select a File from the Music Search List

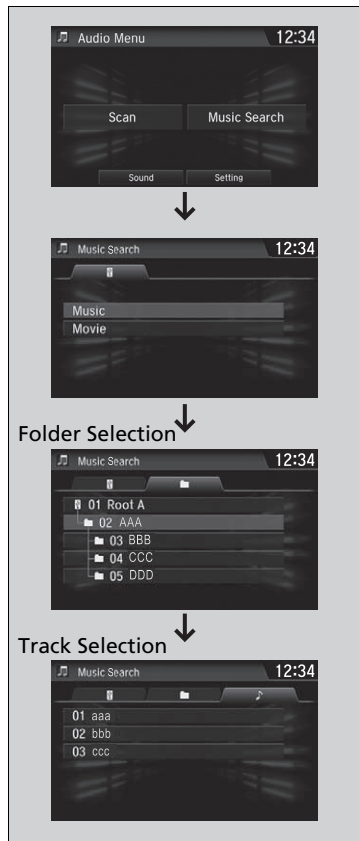

1. Select  and select **Music Search**.

2. Select **Music** or **Movie**.

3. Select a folder.

4. Select a track.

▶▶ Playing a USB Flash Drive

Use the recommended USB flash drives.

 **General Information on the Audio System**
P. 353

WMA files protected by digital rights management (DRM) cannot be played.

The audio system displays **Unplayable File**, then skips to the next file.

If there is a problem, you may see an error message on the audio/information screen.

 **iPod/USB Flash Drive** P. 350

How to Select a Play Mode

You can select scan, repeat, and random modes when playing a file.

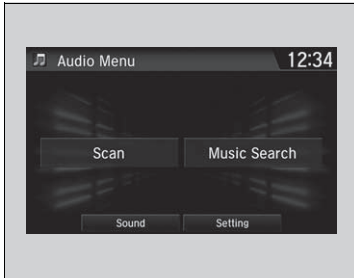

■ Scan

1. Select .
2. Select **Scan**.
3. Select a play mode.

■ Random/Repeat

Select a play mode.

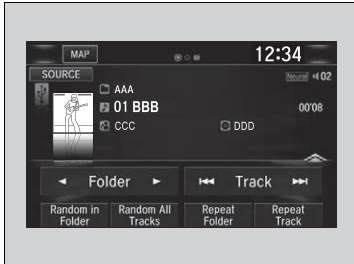

■ To turn off a play mode

To turn off Scan, select  or **Cancel**.

To turn off random or repeat, select the mode again.

How to Select a Play Mode

Play Mode Menu Items

Scan

Scan Folders: Provides 10-second sampling of the first file in each of the main folders.

Scan Tracks: Provides 10-second sampling of all files in the current folder.

Random/Repeat

Random in Folder: Plays all files in the current folder in random order.

Random All Tracks: Plays all files in random order.

Repeat Folder: Repeats all files in the current folder.

Repeat Track: Repeats the current file.

When playing a video file:

Play/Pause: Plays or pauses the file.

Stop: Stops the file.

Playing *Bluetooth*® Audio

Your audio system allows you to listen to music from your *Bluetooth*-compatible phone.

This function is available when the phone is paired and connected to the vehicle's Hands-Free Telephone (HFT) system.

☑ **Phone Setup** P. 422

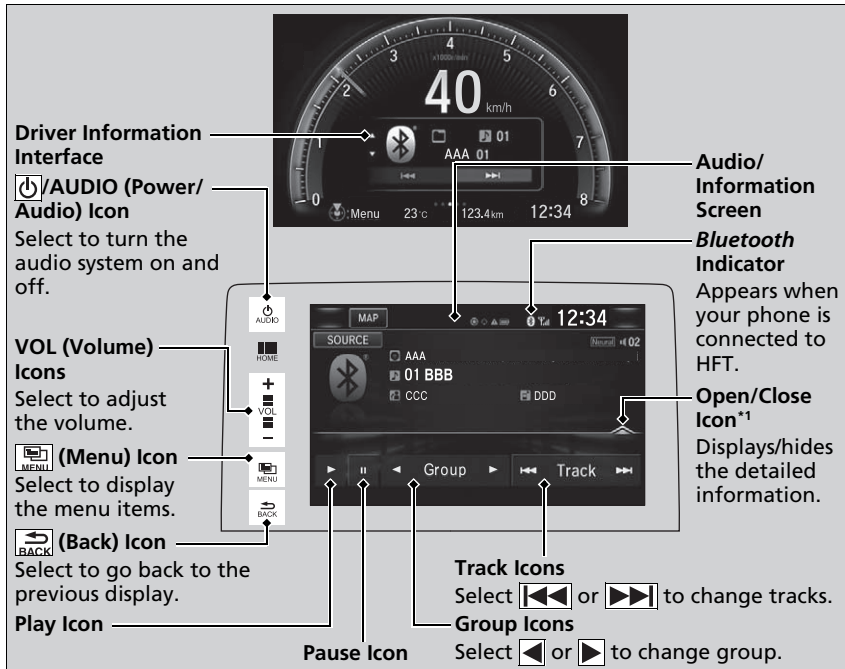

*1: Depending on the *Bluetooth*® device you connect, some or all of the lists may not be displayed.

▶▶ Playing *Bluetooth*® Audio

Not all *Bluetooth*-enabled phones with streaming audio capabilities are compatible, ask a dealer.

It may be illegal to perform some data device functions while driving.

Only one phone can be used with HFT at a time. When there are more than two paired phones in the vehicle, the first paired phone the system finds is automatically connected.

The connected phone for *Bluetooth*® Audio can be different.

If more than one phone is paired to the HFT system, there may be a delay before the system begins to play.

In some cases, the name of the artist, album, or track may not appear correctly.

Some functions may not be available on some devices.

If a phone is currently connected via Apple CarPlay or Android Auto, *Bluetooth*® Audio from that phone is unavailable. However, a second previously paired phone can stream *Bluetooth*® Audio by selecting **Connect**  from the **Bluetooth Device List** screen.

☑ **Phone Setup** P. 422

To Play *Bluetooth*® Audio Files

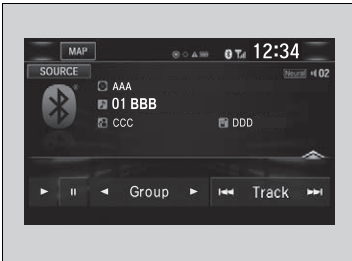

1. Make sure that your phone is paired and connected to the system.
 ▶ **Phone Setup** P. 422
2. Select the *Bluetooth*® Audio mode.

If the phone is not recognized, another HFT-compatible phone, which is not compatible for *Bluetooth*® Audio, may already be connected.

To pause or resume a file

Select the play icon or pause icon.

Searching for Music

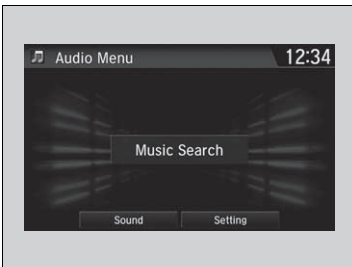

1. Select .
2. Select **Music Search**.
3. Select a search category (e.g., Albums).
4. Select an item.
 ▶ The selection begins playing.

To Play *Bluetooth*® Audio Files

To play the audio files, you may need to operate your phone. If so, follow the phone maker's operating instructions.

Switching to another mode pauses the music playing from your phone.

You can change the connected phone in the *Bluetooth*® settings on the **Audio Menu** screen by the following procedure.

1. Select .
2. Select **Setting**.

Searching for Music

Depending on the *Bluetooth*® device you connect, some or all of the lists may not be displayed.

Playing a Video Using the HDMI™

Your audio system allows you to play videos from an HDMI-compatible device. Connect the device, using an HDMI™ cable, then select the HDMI™ mode.

➤ **HDMI™ Port*** P. 255



Driver Information Interface

 **/AUDIO (Power/Audio) Icon**

Select to turn the audio system on and off.

 **VOL (Volume) Icons**

Select to adjust the volume.

 **(Menu) Icon**

Select to display the menu items.

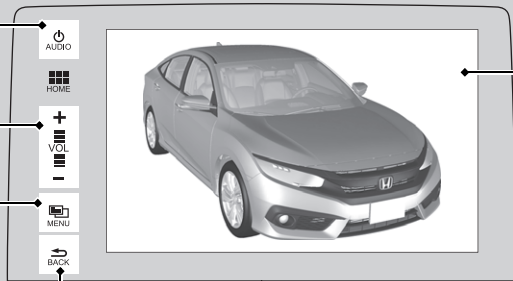



Audio/Information Screen

 **(Back) Icon**

Select to go back to the previous display.

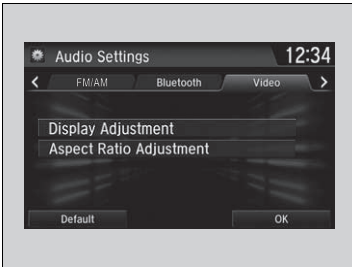
Changing the Screen Aspect



1. Select .
2. Select **Settings**.
3. Select **Audio**.
4. Select the **Video** tab.
5. Select **Aspect Ratio Adjustment**.
6. Select the setting you want.
7. Select **OK**.

▶▶ Playing a Video Using the HDMI™

This feature is limited while driving. To play videos, stop your vehicle and apply the parking brake.

On Board Apps*

Honda Connect has the capability of On Board Apps which may be created by Honda or by 3rd parties. Apps may be already installed or can be downloaded through Honda App Centre. Some Apps require internet access which can be established by Wi-Fi Connection.

➤ **Wi-Fi Connection** P. 340

Please visit the below web address for further information:

<https://ivhs.os.ixonos.com/honda/category/carApps.html>

▶▶ On Board Apps*

Even if you change **Background Colour** on the **System Settings** screen, it will not be reflected on the Honda App Centre screen.

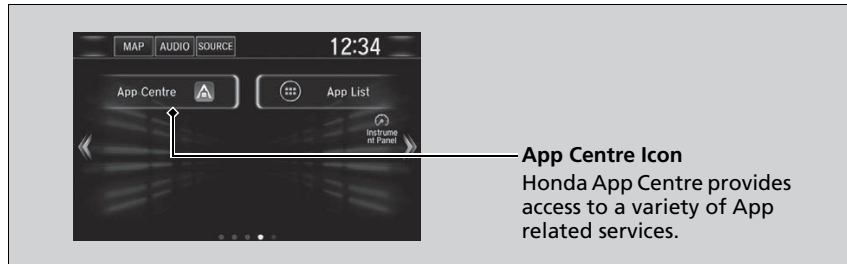

- Using the Display Audio system while driving can take your attention away from the road, causing a crash in which you could be seriously injured or killed. Only operate system controls when the conditions permit you to safely do so. **Please always adhere to the laws of the territory when operating this device.**
- Applications on the head unit are subject to change at anytime. This may mean that they are not available or operate differently. Honda shall not be liable to you in such instances.
- Applications available on the device may be provided by parties other than Honda to which 3rd party software licences and charges may apply.
- Data usage and roaming charges may result in using applications on the device in conjunction with your mobile phone and Honda is not liable for any costs you might incur from such use. Honda recommends you consult your mobile phone network provider in advance.
- Downloading applications from the Honda App Centre will be subject to Terms and Conditions which can be found at: <https://ivhs.os.ixonos.com/honda/category/carApps.html>, and may also incur charges.

Smartphone Connection

Some of your smartphone apps can be displayed and operated on the audio/information screen when the phone is connected to the audio system. You can connect your phone using a cable, or wirelessly.

- ▶ **Connecting Your iPhone** P. 338
- ▶ **Connecting Your Smartphone** P. 339
- ▶ **Wi-Fi mode (setting for the first time)** P. 340

To use smartphone connection, you need to first pair your smartphone to the audio system via *Bluetooth*®.

- ▶ **Phone Setup** P. 422

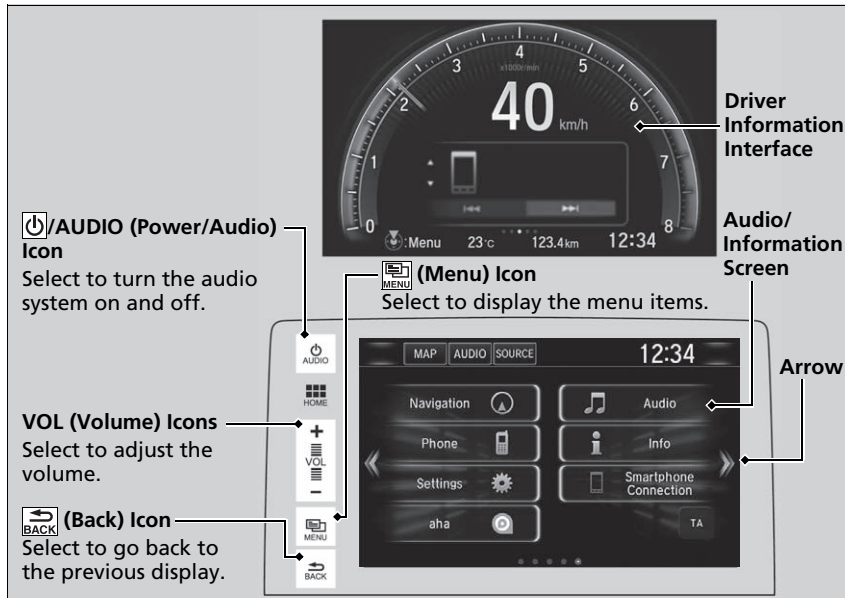

Continued

Smartphone Connection

Park in a safe place before connecting your phone and while operating the displayed apps.

Not all phones are compatible with the system. The system does not display all the available apps on your smartphone, and some apps need to be preinstalled. Ask a dealer for details.

You need to switch the *Bluetooth*® connection to your smartphone if another electronic device is connected.

- ▶ **To change the currently paired phone**
P. 423

The following may vary by phone type:

- How to connect a smartphone to the system.
- Apps that can be operated on the screen.
- Display response time/update time.

We do not support every app operation on the audio system.

Ask the app provider for any queries on the app's features.

Do not get drawn into the display while operating a vehicle.

■ Connecting Your iPhone

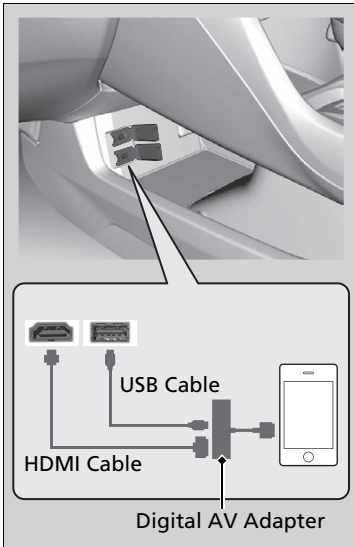

1. Connect your phone to the audio system via *Bluetooth*®.
 - ▶ **Phone Setup** P. 422
2. Plug in the digital AV adapter to the HDMI™ port.
3. Connect the digital AV adapter to your iPhone.
 - ▶ Wait until an arrow appears on the home screen.
4. Select the arrow to display the available smartphone apps on the audio/information screen.
 - ▶ You may need to operate from the phone.
5. Select an app you want to operate from the audio/information screen.
 - ▶ To go back to the previous screen, select



▶▶ Connecting Your iPhone

Make sure to plug in the digital AV adapter to the HDMI™ port first. If not, smartphone connection may not work properly.

To recharge your phone, connect it to the USB port, too.

Contact a dealer for the digital AV adapter or HDMI™ purchasing information.

■ Connecting Your Smartphone

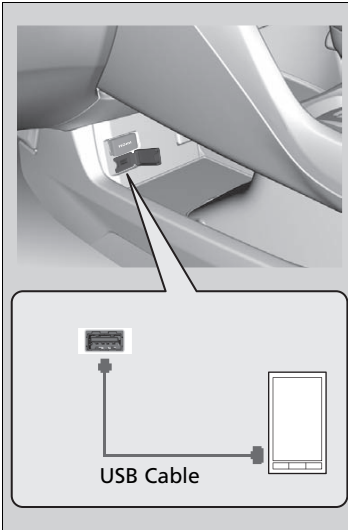

1. Connect your phone to the audio system via *Bluetooth*®.
 - ▶ **Phone Setup** P. 422
2. Plug in your phone to the USB jack.
 - ▶ You may need to operate from the phone.
 - ▶ Wait until an arrow appears on the home screen.
3. Select the arrow to display the available smartphone apps on the audio/information screen.
4. Select an app you want to operate from the audio/information screen.
 - ▶ To go back to the previous screen, select 

☒ Connecting Your Smartphone



The phone is rechargeable while being connected to the USB jack. However, if the phone is overloaded with many operational tasks, the battery level may get lowered.

Wi-Fi Connection

You can connect the Display Audio to the Internet using Wi-Fi and browse websites or use online services on the audio/information screen. If your phone has wireless hotspot capabilities, the system can be tethered to the phone. Use the following steps to setup.

Wi-Fi mode (setting for the first time)



1. Select .
2. Select **Settings**.
3. Select **Bluetooth / Wi-Fi**.
4. Select the **Wi-Fi** tab.
5. Select **Wi-Fi On/Off Status**, then **On**.
6. Select **Wi-Fi Device List**.
 - ▶ Make sure your phone's Wi-Fi setting is in access point (tethering) mode.
 - ▶ Select the phone you want to connect to the system.
 - ▶ If you do not find the phone you want to connect in the list, select **Scan**.
7. Select **Add**.
 - ▶ If needed, enter a password for your phone and select **OK**.
 - ▶ When the connection is successful, the  icon is displayed on the top of the screen.
8. Select  to go back to the home screen.

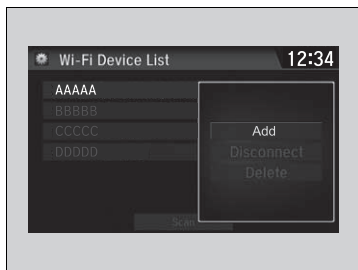

Wi-Fi mode (setting for the first time)

You cannot go through the setting procedure while a vehicle is moving. Park in a safe place to setup the Wi-Fi connection.

Some mobile phone carriers charge for tethering and smartphone data use. Check your phone's data subscription package.

Check your phone manual to find out if the phone has Wi-Fi connectivity.

You can confirm whether Wi-Fi connection is on or off with the  icon on the **Wi-Fi Device List** screen. Network speed will not be displayed on this screen.

■ Wi-Fi mode (after the initial setting has been made)

Make sure your phone's Wi-Fi setting is in access point (tethering) mode.

☒ Wi-Fi mode (after the initial setting has been made)

iPhone users

You may need to go through an initial setup for Wi-Fi connection again after you boot your phone.

Siri Eyes Free

You can talk to Siri using the  (Talk) button on the steering wheel when your iPhone is paired to the Hands-Free Telephone (HFT) system.

➔ **Phone Setup** P. 422

❏ Siri Eyes Free

Siri is a trademark of Apple Inc.

Check Apple Inc. website for features available for Siri.

We recommend against using Siri other than in Siri Eyes Free while operating a vehicle.

❏ Using Siri Eyes Free

Some commands work only on specific phone features or apps.

■ Using Siri Eyes Free

 **(Hang-up/back) Button**
Press to deactivate Siri Eyes Free.

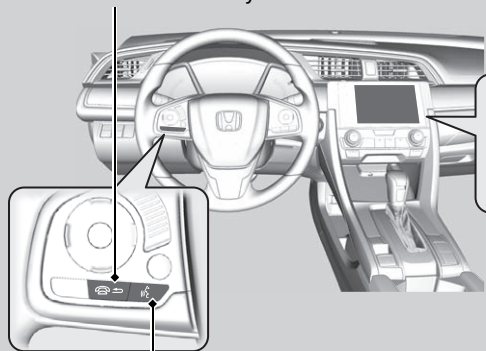

Appears when Siri is activated in Siri Eyes Free

While in Siri Eyes Free:
The display remains the same.
No feedback or commands appear.

 **(Talk) Button**
Press and hold until the display changes as shown.

Apple CarPlay

If you connect an Apple CarPlay-compatible iPhone to the system via the 1.5A USB port, you can use the audio/information screen, instead of the iPhone display, to make a phone call, listen to music, view maps (navigation), and access messages.

📄 **USB Port(s)** P. 253

Apple CarPlay Menu

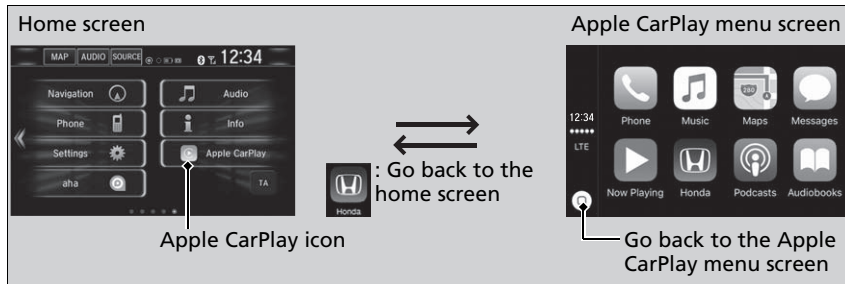

■ Phone

Access the contact list, make phone calls, or listen to voice mail.

■ Messages

Check and reply to text messages, or have messages read to you.

■ Music

Play music stored on your iPhone.

📄 Apple CarPlay

Only iPhone 5 or newer versions with iOS 8.4 or later are compatible with Apple CarPlay.

Park in a safe place before connecting your iPhone to Apple CarPlay and when launching any compatible apps.

To use Apple CarPlay, connect the USB cable to the 1.5A USB port. The USB port located in the centre console storage will not enable Apple CarPlay operation.

📄 **USB Port(s)** P. 253

To directly access the Apple CarPlay phone function, select **Phone** on the home screen. While connected to Apple CarPlay, calls are only made through Apple CarPlay. If you want to make a call with the Hands-Free Telephone system, turn Apple CarPlay OFF or detach the USB cable from your iPhone.

📄 **Setting Up Apple CarPlay** P. 344

When your iPhone is connected to Apple CarPlay, it is not possible to use the *Bluetooth*® Audio or Hands-Free Telephone system. However, other previously paired phones can stream audio via *Bluetooth*® while Apple CarPlay is connected.

📄 **Phone Setup** P. 422

For details on countries and regions where Apple CarPlay is available, as well as information pertaining to function, refer to the Apple homepage.

■ Maps

Display Apple CarPlay map and use the navigation function just as you would on your iPhone.

Models with navigation system

Only one navigation system (pre-installed navigation or Apple CarPlay) can give directions at a time. When you are using one system, directions to any prior destination set on the other system will be cancelled, and the system you are currently using will direct you to your destination.

■ Setting Up Apple CarPlay

After you have connected your iPhone to the system via the 1.5A USB port, use the following procedure to set up Apple CarPlay. Use of Apple CarPlay will result in the transmission of certain user and vehicle information (such as vehicle location, speed, and status) to your iPhone to enhance the Apple CarPlay experience. You will need to consent to the sharing of this information on the Display Audio Screen.

■ Enabling Apple CarPlay

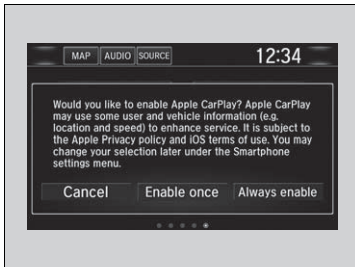

Enable once: Allows only once. (Prompt shows again next time.)

Always enable: Allows anytime. (Prompt does not show again.)

Cancel: Does not allow this consent.

You may change the consent settings under the **Smartphone** settings menu.

▶▶ Apple CarPlay

Apple CarPlay Operating Requirements & Limitations

Apple CarPlay requires a compatible iPhone with an active cellular connection and data plan. Your carrier's rate plans will apply.

Changes in operating systems, hardware, software, and other technology integral to providing Apple CarPlay functionality, as well as new or revised governmental regulations, may result in a decrease or cessation of Apple CarPlay functionality and services. Honda cannot and does not provide any warranty or guarantee of future Apple CarPlay performance or functionality.

It is possible to use 3rd party apps if they are compatible with Apple CarPlay. Refer to the Apple homepage for information on compatible apps.

▶▶ Setting Up Apple CarPlay

You can also use the method below to set up Apple CarPlay:
Select HOME→Settings→Smartphone→Apple CarPlay

Use of user and vehicle information

The use and handling of user and vehicle information transmitted to/from your iPhone by Apple CarPlay is governed by the Apple iOS terms and conditions and Apple's Privacy Policy.

■ Operating Apple CarPlay with Siri Eyes Free

Press and hold the  (talk) button to activate Siri Eyes Free.



☒ Operating Apple CarPlay with Siri Eyes Free

Below are examples of questions and commands for Siri Eyes Free.

- What movies are playing today?
- Call dad at work.
- What song is this?
- How's the weather tomorrow?
- Read my latest email.

For more information, please visit www.apple.com/ios/siri.

Android Auto

When you connect an Android phone to the Display Audio system via the 1.5A USB port, Android Auto is automatically initiated. When connected via Android Auto, you can use the audio/information screen to access the Phone, Google Maps (Navigation), Google Play Music, and Google Now functions. When you first use Android Auto, a tutorial will appear on the screen.

We recommend that you complete this tutorial while safely parked before using Android Auto.

🔗 **USB Port(s)** P. 253

🔗 **Auto Pairing Connection** P. 348

NOTE:

Android Auto may not be available in your country or region. For details about Android Auto, please refer to the Google support site.

🔗 Android Auto

To use Android Auto, you need to download the Android Auto app from Google Play to your smartphone.

Only Android 5.0 (Lollipop) or later versions are compatible with Android Auto. *Bluetooth*® A2DP cannot be used with Android Auto phone.

Park in a safe place before connecting your Android phone to Android Auto and when launching any compatible apps.

To use Android Auto, connect the USB cable to the 1.5A USB port. The USB port in the centre console storage will not enable Android Auto operation.

🔗 **USB Port(s)** P. 253

To directly access the Android Auto phone function, select **Phone** on the home screen.

🔗 **Auto Pairing Connection** P. 348

When your Android phone is connected to Android Auto, it is not possible to use the *Bluetooth*® Audio. However, other previously paired phones can stream audio via *Bluetooth*® while Android Auto is connected.

🔗 **Phone Setup** P. 422

Android Auto Menu

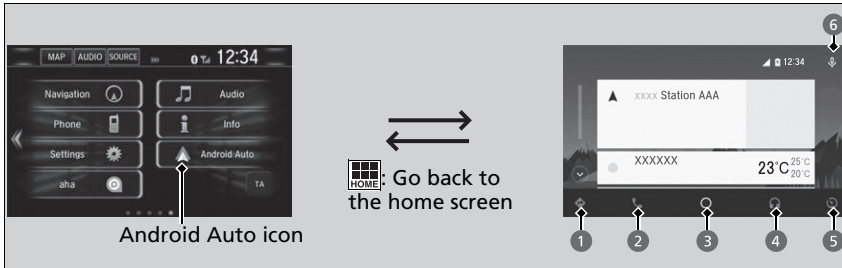

1 Maps (Navigation)

Display Google Maps and use the navigation function just as you would with your Android phone. When the vehicle is in motion, it is not possible to make keyboard entries. Stop the vehicle in a safe location to undertake a search or provide other inputs.

Models with navigation system

Only one navigation system (pre-installed navigation or Android Auto) can give directions at a time. When you are using one system, directions to any prior destination set on the other system will be cancelled, and the system you are currently using will direct you to your destination.

The audio/Information screen shows you turn-by-turn driving directions to your destination.

2 Phone (Communication)

Make and receive phone calls as well as listen to voicemail.

3 Google Now (Home screen)

Display useful information organized by Android Auto into simple cards that appear just when they're needed.

Android Auto

For details on countries and regions where Android Auto is available, as well as information pertaining to function, refer to the Android Auto homepage.

Android Auto Operating Requirements & Limitations

Android Auto requires a compatible Android phone with an active cellular connection and data plan. Your carrier's rate plans will apply.

Changes in operating systems, hardware, software, and other technology integral to providing Android Auto functionality, as well as new or revised governmental regulations, may result in a decrease or cessation of Android Auto functionality and services. Honda cannot and does not provide any warranty or guarantee of future Android Auto performance or functionality.

It is possible to use 3rd party apps if they are compatible with Android Auto. Refer to the Android Auto homepage for information on compatible apps.

4 Music and audio

Play Google Play Music and music apps that are compatible with Android Auto. To switch between music apps, press this icon.

5 Go back to the Home Screen.

6 Voice

Operate Android Auto with your voice.

Auto Pairing Connection

When you connect an Android phone to the unit via the 1.5A USB port, Android Auto is automatically initiated.

Enabling Android Auto

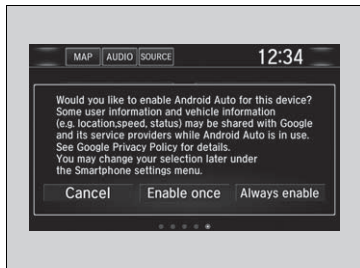

Enable once: Allows only once. (Prompt shows again next time.)

Always enable: Allows anytime. (Prompt does not show again.)

Cancel: Does not allow this consent.

You may change the consent settings under the **Smartphone** settings menu.

Enabling Android Auto

Only initialize Android Auto when you safely parked. When Android Auto first detects your phone, you will need to set up your phone so that auto pairing is possible. Refer to the instruction manual that came with your phone.

You can use the method below to change Android Auto settings after you have completed the initial setup:
Select HOME→Settings→Smartphone→Android Auto

Use of user and vehicle information

The use and handling of user and vehicle information transmitted to/from your phone by Android Auto is governed by the Google's Privacy Policy.

■ Operating Android Auto with Voice Recognition

Press and hold the  (talk) button to operate Android Auto with your voice.



☒ Operating Android Auto with Voice Recognition

Below are examples of commands you can give with voice recognition:

- Reply to text.
- Call my wife.
- Navigate to Honda.
- Play my music.
- Send a text message to my wife.
- Call flower shop.

For more information, please refer to the Android Auto homepage.

You can also activate the voice recognition function by pressing the  icon in the upper-right corner of the screen.

iPod/USB Flash Drive

If an error occurs while playing an iPod or USB flash drive, you may see the following error messages. If you cannot clear the error message, contact a dealer.

Error Message	Solution
USB error ^{*1} USB Error ^{*2}	Appears when there is a problem with the audio system. Check if the device is compatible with the audio system.
Incompatible USB device Please check owners manual. ^{*1} A charging error has occurred with the connected USB device. When safe please check the compatibility of the device and USB cable and try again. ^{*2}	Appears when an incompatible device is connected. Disconnect the device. Then turn the audio system off, and turn it on again. Do not reconnect the device that caused the error.
Unsupported ver ^{*1} Unsupported Version ^{*2}	Appears when an unsupported iPod is connected. If it appears when a supported iPod is connected, update the iPod software to the newer version.
Retry connection ^{*1} Connect Retry ^{*2}	Appears when the system does not acknowledge the iPod. Reconnect the iPod.

*1:Models with colour audio system

*2:Models with Display Audio

Error Message	Solution
Unplayable file ^{*1} Unplayable File ^{*2}	Appears when the files in the USB flash drive are copyright protected or an unsupported format. This error message appears for about three seconds, then plays the next song.
No song ^{*1} No Data ^{*2}	<p>iPod Appears when the iPod is empty.</p> <p>USB flash drive Appears when the USB flash drive is empty or there are no MP3, WMA, AAC, WAV^{*2}, or MP4^{*2} files in the USB flash drive.</p> <p>iPod and USB flash drive Check that compatible files are stored on the device.</p>
Unsupported ^{*1, *2}	Appears when an unsupported device is connected. If it appears when a supported device is connected, reconnect the device.

*1:Models with colour audio system

*2:Models with Display Audio

Models with Display Audio

Android/Apps

If an error occurs while using the audio system or apps, you may see the following error messages. If you cannot clear the error message, contact a dealer.

Error Message ^{*1}	Solution
Unfortunately, **** has stopped.	Error has occurred within app, select OK on the screen to close the app.
**** is not responding. Would you like to close it?	App is not responding. Select Wait if you can wait for a response from app a little longer. If it does not respond even if you keep waiting, select OK to close the app and start it up. If the error message continues, perform Factory Data Reset .  Defaulting All the Settings P. 393

*1: ****part is variable characters, and will change depending upon where an error occurs.

Compatible iPod, iPhone, and USB Flash Drives

iPod and iPhone Model Compatibility

Model
iPod (5th generation)
iPod classic 80GB/160GB (launch in 2007)
iPod classic 120GB (launch in 2008)
iPod classic 160GB (launch in 2009)
iPod nano (1st to 7th generation) released between 2005 and 2012
iPod touch (1st to 5th generation) released between 2007 and 2012
iPhone 3G/iPhone 3GS/iPhone 4/iPhone 4S/iPhone 5/iPhone 5c ^{*1} /iPhone 5s ^{*1} / iPhone 6 ^{*1} /iPhone 6 Plus ^{*1}

*1: Models with Display Audio

USB Flash Drives

- A USB flash drive of 256 MB or higher is recommended.
- Some digital audio players may not be compatible.
- Some USB flash drives (e.g., a device with security lockout) may not work.
- Some software files may not allow for audio play or text data display.
- Some versions of MP3, WMA, AAC, WAV*, or MP4* formats may be unsupported.

* Not available on all models

iPod and iPhone Model Compatibility

This system may not work with all software versions of these devices.

USB Flash Drives

Files on the USB flash drive are played in their stored order. This order may be different from the order displayed on your PC or device.

Continued

Models with Display Audio

Recommended Devices

Media	USB Flash Drive	
Profile (MP4 version)	Baseline Level 3 (MPEG4-AVC), Simple Level 5 (MPEG4)	
File extension (MP4 version)	.mp4/.m4v	
Compatible audio codec	AAC	MP3
Compatible video codec	MPEG4-AVC (H.264)	MPEG4 (ISO/IEC 14496 Part.2)
Bit rate	10 Mbps (MPEG4-AVC)	8 Mbps (MPEG4)
Maximum image	720 x 576 pixels	

Models with Display Audio

Legal Information on Apple CarPlay/Android Auto

OWNER'S MANUAL LICENCE/LIABILITY STATEMENTS

USE OF APPLE CARPLAY IS SUBJECT TO YOUR AGREEMENT TO THE CARPLAY TERMS OF USE, WHICH ARE INCLUDED AS PART OF THE APPLE iOS TERMS OF USE. IN SUMMARY, THE CARPLAY TERMS OF USE DISCLAIM APPLE AND ITS SERVICE PROVIDERS' LIABILITY IF THE SERVICES FAIL TO PERFORM CORRECTLY OR ARE DISCONTINUED, STRICTLY LIMIT APPLE AND ITS SERVICE PROVIDERS' OTHER LIABILITIES, DESCRIBE THE KINDS OF USER INFORMATION (INCLUDING, FOR EXAMPLE, VEHICLE LOCATION, VEHICLE SPEED, AND VEHICLE STATUS) BEING GATHERED AND STORED BY APPLE AND ITS SERVICE PROVIDERS, AND DISCLOSE CERTAIN POSSIBLE RISKS ASSOCIATED WITH THE USE OF CARPLAY, INCLUDING THE POTENTIAL FOR DRIVER DISTRACTION. SEE APPLE'S PRIVACY POLICY FOR DETAILS REGARDING APPLE'S USE AND HANDLING OF DATA UPLOADED BY CARPLAY.

USE OF ANDROID AUTO IS SUBJECT TO YOUR AGREEMENT TO THE ANDROID AUTO TERMS OF USE WHICH MUST BE AGREED TO WHEN THE ANDROID AUTO APPLICATION IS DOWNLOADED TO YOUR ANDROID PHONE. IN SUMMARY, THE ANDROID AUTO TERMS OF USE DISCLAIM GOOGLE AND ITS SERVICE PROVIDERS' LIABILITY IF THE SERVICES FAIL TO PERFORM CORRECTLY OR ARE DISCONTINUED, STRICTLY LIMIT GOOGLE AND ITS SERVICE PROVIDERS' OTHER LIABILITIES, DESCRIBE THE KINDS OF USER INFORMATION (INCLUDING, FOR EXAMPLE, VEHICLE LOCATION, VEHICLE SPEED, AND VEHICLE STATUS) BEING GATHERED AND STORED BY GOOGLE AND ITS SERVICE PROVIDERS, AND DISCLOSE CERTAIN POSSIBLE RISKS ASSOCIATED WITH THE USE OF ANDROID AUTO, INCLUDING THE POTENTIAL FOR DRIVER DISTRACTION. SEE GOOGLE'S PRIVACY POLICY FOR DETAILS REGARDING GOOGLE'S USE AND HANDLING OF DATA UPLOADED BY ANDROID AUTO.

■ **DISCLAIMER OF WARRANTIES; LIMITATION ON LIABILITY**





YOU EXPRESSLY ACKNOWLEDGE AND AGREE THAT USE OF APPLE CARPLAY OR ANDROID AUTO (“THE APPLICATIONS”) IS AT YOUR SOLE RISK AND THAT THE ENTIRE RISK AS TO SATISFACTORY QUALITY, PERFORMANCE, ACCURACY AND EFFORT IS WITH YOU TO THE MAXIMUM EXTENT PERMITTED BY APPLICABLE LAW, AND THAT THE APPLICATIONS AND INFORMATION ON THE APPLICATIONS IS PROVIDED “AS IS” AND “AS AVAILABLE,” WITH ALL FAULTS AND WITHOUT WARRANTY OF ANY KIND, AND HONDA HEREBY DISCLAIMS ALL WARRANTIES AND CONDITIONS WITH RESPECT TO THE APPLICATIONS AND INFORMATION ON THE APPLICATIONS, EITHER EXPRESS, IMPLIED OR STATUTORY, INCLUDING, BUT NOT LIMITED TO, THE IMPLIED WARRANTIES AND/OR CONDITIONS OF MERCHANTABILITY, SATISFACTORY QUALITY, FITNESS FOR A PARTICULAR PURPOSE, ACCURACY, QUIET ENJOYMENT, AND NON-INFRINGEMENT OF THIRD PARTY RIGHTS. NO ORAL OR WRITTEN INFORMATION OR ADVICE GIVEN BY HONDA OR AN AUTHORISED REPRESENTATIVE SHALL CREATE A WARRANTY. AS EXAMPLES, AND WITHOUT LIMITATION, HONDA DISCLAIMS ANY WARRANTY REGARDING THE ACCURACY OF DATA PROVIDED BY THE APPLICATIONS, SUCH AS THE ACCURACY OF DIRECTIONS, ESTIMATED TRAVEL TIME, SPEED LIMITS, ROAD CONDITIONS, NEWS, WEATHER, TRAFFIC, OR OTHER CONTENT PROVIDED BY APPLE, GOOGLE, THEIR AFFILIATES, OR THIRD PARTY PROVIDERS; HONDA DOES NOT GUARANTEE AGAINST LOSS OF APPLICATION DATA, WHICH MAY BE LOST AT ANY TIME; HONDA DOES NOT GUARANTEE THAT THE APPLICATIONS OR ANY SERVICES PROVIDED THROUGH THEM WILL BE PROVIDED AT ALL TIMES OR THAT ANY OR ALL SERVICES WILL BE AVAILABLE AT ANY PARTICULAR TIME OR LOCATION. FOR EXAMPLE, SERVICES MAY BE SUSPENDED OR INTERRUPTED WITHOUT NOTICE FOR REPAIR, MAINTENANCE, SECURITY FIXES, UPDATES, ETC., SERVICES MAY BE UNAVAILABLE IN YOUR AREA OR LOCATION, ETC. IN ADDITION, YOU UNDERSTAND THAT CHANGES IN THIRD PARTY TECHNOLOGY OR GOVERNMENT REGULATION MAY RENDER THE SERVICES AND/OR APPLICATIONS OBSOLETE AND/OR UNUSABLE.

TO THE EXTENT NOT PROHIBITED BY LAW, IN NO EVENT SHALL HONDA OR ITS AFFILIATES BE LIABLE FOR PERSONAL INJURY, OR ANY INCIDENTAL, SPECIAL, INDIRECT OR CONSEQUENTIAL DAMAGES WHATSOEVER, INCLUDING, WITHOUT LIMITATION, DAMAGES FOR LOSS OF PROFITS, CORRUPTION OR LOSS OF DATA, FAILURE TO TRANSMIT OR RECEIVE ANY DATA, BUSINESS INTERRUPTION OR ANY OTHER COMMERCIAL DAMAGES OR LOSSES, ARISING OUT OF OR RELATED TO THE APPLICATIONS OR YOUR USE OF OR INABILITY TO USE THE APPLICATIONS OR INFORMATION ON THE APPLICATIONS, HOWEVER CAUSED, REGARDLESS OF THE THEORY OF LIABILITY (CONTRACT, TORT OR OTHERWISE) AND EVEN IF HONDA WERE ADVISED OF THE POSSIBILITY OF SUCH DAMAGES. SOME REGIONS AND JURISDICTIONS MAY DISALLOW THE EXCLUSION OR LIMITATION OF LIABILITY FOR DAMAGES, SO THESE LIMITATIONS AND EXCLUSIONS MAY NOT APPLY TO YOU. THE FOREGOING LIMITATIONS WILL APPLY EVEN IF THE ABOVE STATED REMEDY FAILS OF ITS ESSENTIAL PURPOSE.

About Open Source Licences

To see the open source licences information, follow these steps.

Models with colour audio system

1. Press the **MENU/CLOCK** button.
2. Rotate  to select **Settings**, then press .
3. Rotate  to select **OSS Licenses**, then press .

Models with Display Audio

1. Select .
2. Select **Settings**.
3. Select **System**.
4. Select the **Others** tab.
5. Select **Detailed Information**.
6. Select **About device**.
7. Select **Legal information**.
8. Select **Open-source licences**.

⌘ About Open Source Licences

LICENCE: Copyright © 2001 Bob Trower, Trantor Standard Systems Inc.

Permission is hereby granted, free of charge, to any person obtaining a copy of this software and associated documentation files (the "Software"), to deal in the Software without restriction, including without limitation the rights to use, copy, modify, merge, publish, distribute, sublicense, and/or sell copies of the Software, and to permit persons to whom the Software is furnished to do so, subject to the following conditions:

The above copyright notice and this permission notice shall be included in all copies or substantial portions of the Software.

THE SOFTWARE IS PROVIDED "AS IS", WITHOUT WARRANTY OF ANY KIND, EXPRESS OR IMPLIED, INCLUDING BUT NOT LIMITED TO THE WARRANTIES OF MERCHANTABILITY, FITNESS FOR A PARTICULAR PURPOSE AND NONINFRINGEMENT. IN NO EVENT SHALL THE AUTHORS OR COPYRIGHT HOLDERS BE LIABLE FOR ANY CLAIM, DAMAGES OR OTHER LIABILITY, WHETHER IN AN ACTION OF CONTRACT, TORT OR OTHERWISE, ARISING FROM, OUT OF OR IN CONNECTION WITH THE SOFTWARE OR THE USE OR OTHER DEALINGS IN THE SOFTWARE.

Models with Display Audio

Licence Information

DTS

For DTS patents, see <http://patents.dts.com>. Manufactured under license from DTS Licensing Limited. DTS, the Symbol, & DTS and the Symbol together are registered trademarks, and DTS Digital Surround and Neural Surround are trademarks of DTS, Inc. © DTS, Inc. All Rights Reserved.





Customized Features

Use the audio/information screen to customize certain features.

Models with colour audio system

How to customize

While the vehicle is at a complete stop with the ignition switch in ON *1, press the **MENU/CLOCK** button, then select **Settings**. To customize the phone settings, press the  button, then select **Phone setup**.

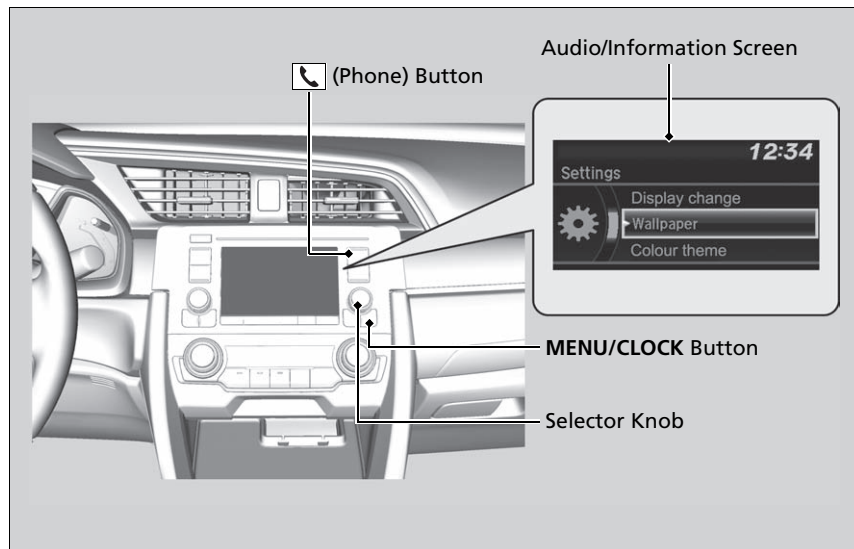

*1: Models with the keyless access system have an **ENGINE START/STOP** button instead of an ignition switch.

Customized Features

When you customize settings:

- Make sure that the vehicle is at a complete stop.

Continuously variable transmission models

- Shift to **P**.

Manual transmission models



- Set the parking brake.

How to customize

These indications are used to show how to operate the selector knob.

Rotate  to select.

Press  to enter.

To customize other features, select **Settings**, rotate , then press .

➔ **List of customizable options** P. 363

Models with colour audio system

■ Customization Flow

Press the **MENU/CLOCK** button.

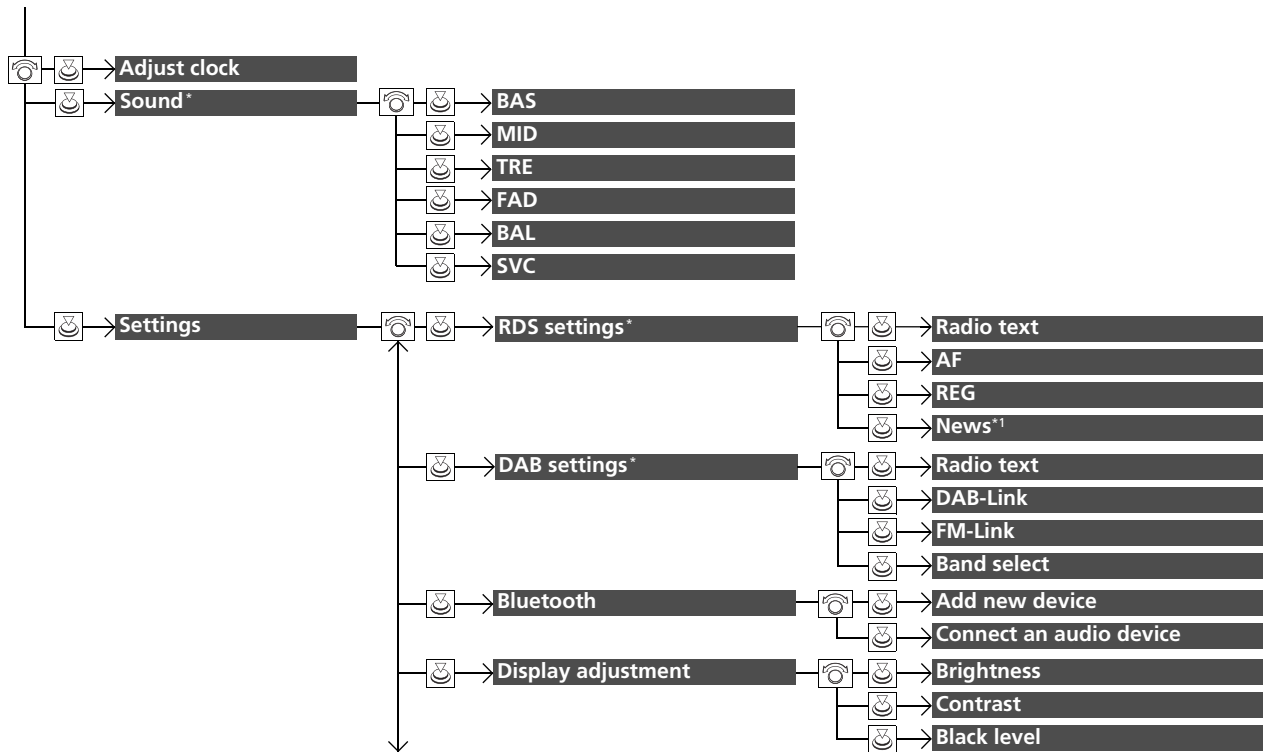

1: Except AM/FM/DAB mode

* Not available on all models

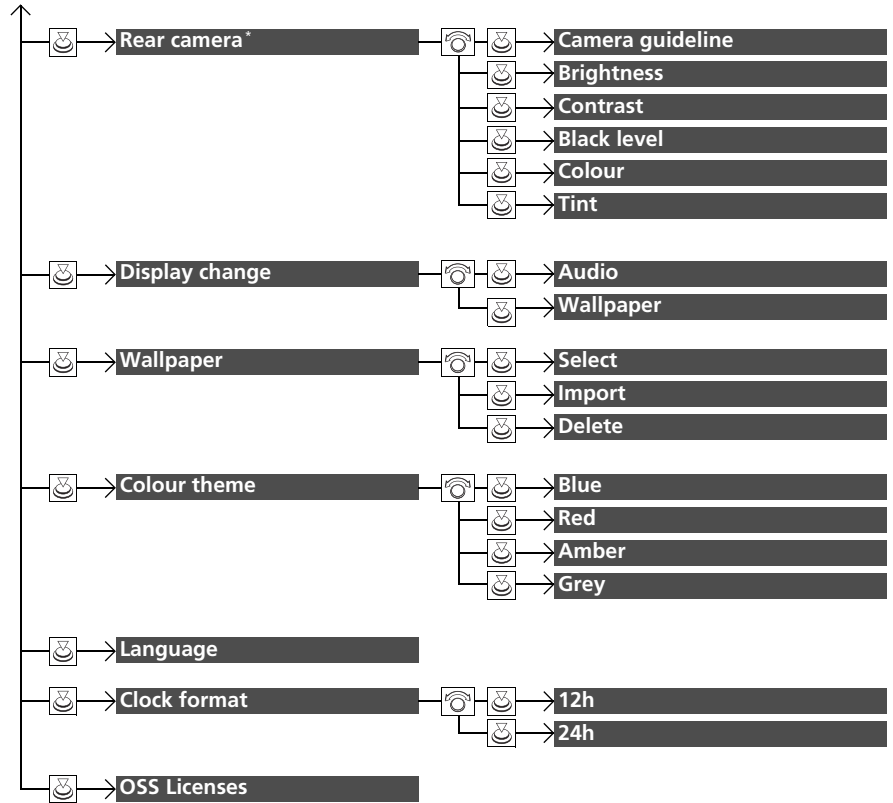

Features

* Not available on all models

Press the  button and rotate  to select **Phone setup**, then press .

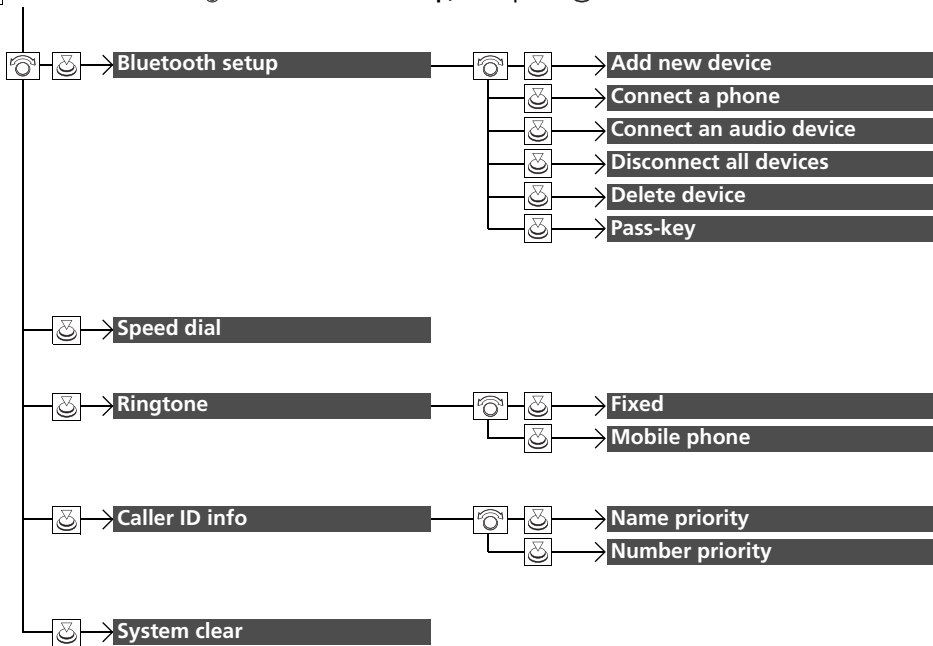

Models with colour audio system

■ List of customizable options

Setup Group	Customizable Features	Description	Selectable Settings	
Adjust clock		Adjusts clock. ▶ Clock P. 170	—	
Sound*		Adjusts the sound. ▶ Adjusting the Sound P. 266	BAS/MID/TRE/FAD/ BAL/SVC	
Settings	RDS settings*	Radio text	Displays the radio text information of the selected RDS station.	On/Off* ¹
		AF	Automatically changes the frequency of the same programme as you enter different region.	On* ¹ /Off
		REG	Keeps the same frequency of the stations within that region even if the signal gets weak.	On* ¹ /Off
		News <small>Except AM/FM/DAB* mode</small>	Turns on and off to automatically to tune to the news programme.	On/Off* ¹
	DAB settings*	Radio text	Displays the radio text information of the selected DAB station.	On/Off* ¹
		DAB-Link	Selects whether the system automatically searches for the same station from Ensembles, and switches to it.	On* ¹ /Off
		FM-Link	Selects whether the system finds the same station from an FM band, and automatically switches the band.	On* ¹ /Off
		Band select	Selects specific bands to reduce the time to update the lists, and search for a station.	Both*¹/BandIII/ L-Band

*1:Default Setting



* Not available on all models

Setup Group	Customizable Features	Description	Selectable Settings
Settings	Bluetooth	Add new device Pairs a new phone to HFT, edits and deletes a paired phone, and create a code for a paired phone. ☒ Phone Setup P. 400	—
		Connect an audio device Connects, disconnects or pairs a <i>Bluetooth</i> ® Audio device to HFT.	—
	Display adjustment	Brightness Changes the brightness of the audio/information screen.	—
		Contrast Changes the contrast of the audio/information screen.	—
		Black level Changes the black level of the audio/information screen.	—
	Rear camera*	Camera guideline Selects whether the guidelines come on the audio/information screen.	On^{*1}/Off
		Brightness	See Display adjustment on P. 364
		Contrast	
		Black level	
		Colour Changes the colour of the audio/information screen.	—
Tint Changes the tint of the audio/information screen.	—		

*1:Default Setting

Setup Group	Customizable Features	Description	Selectable Settings	
Settings	Display change	Changes the display type.	Audio^{*1}/Wallpaper	
	Select	Changes the wallpaper type.	Clock^{*1}/Image 1/Image 2/Image 3	
	Wallpaper	Import	Imports an image file for a new wallpaper.  Wallpaper Setup P. 264	—
		Delete	Deletes an image file for a wallpaper.	Image 1^{*1}/Image 2/Image 3
	Colour theme	Changes the background colour of the audio/information screen.	Blue^{*1}/Red/Amber/Grey	
	Language	Changes the display language.	Israeli, Turkish, and except Middle Eastern models	
			English (United Kingdom)^{*1} or Turkish^{*1} See other selectable languages on the screen.	
	Clock format	Selects the digital clock display from 12H to 24H.	Middle Eastern except Israeli and Turkish models	
Arabic^{*1}/English				
OSS Licenses	Shows the legal information.	—		



*1: Default Setting

Setup Group	Customizable Features	Description	Selectable Settings	
Phone setup	Add new device	Pairs a new phone to HFT.  Phone Setup P. 400	—	
	Bluetooth setup	Connect a phone	Pairs a new phone or connects a paired phone to HFT.  Phone Setup P. 400	—
		Connect an audio device	Connects a <i>Bluetooth</i> ® Audio device to HFT.	—
		Disconnect all devices	Disconnects a paired phone from HFT.	—
		Delete device	Deletes a paired phone.	—
		Pass-key	Inputs and changes a code for a paired phone.	—
	Speed dial	Edits, adds or deletes a speed dial entry.  Speed Dial P. 409	—	
	Ringtone	Selects the ring tone.	Mobile phone *1/ Fixed	
	Caller ID info	Prioritizes the caller's name or phone number as the caller ID.	Name priority *1/ Number priority	
	System clear	Cancels/Resets all customized items in the Phone setup group as default.	—	

*1:Default Setting

Models with Display Audio

■ How to customize

While the vehicle is at a complete stop with the ignition switch in ON *1, select , and **Settings**, then select a setting item.

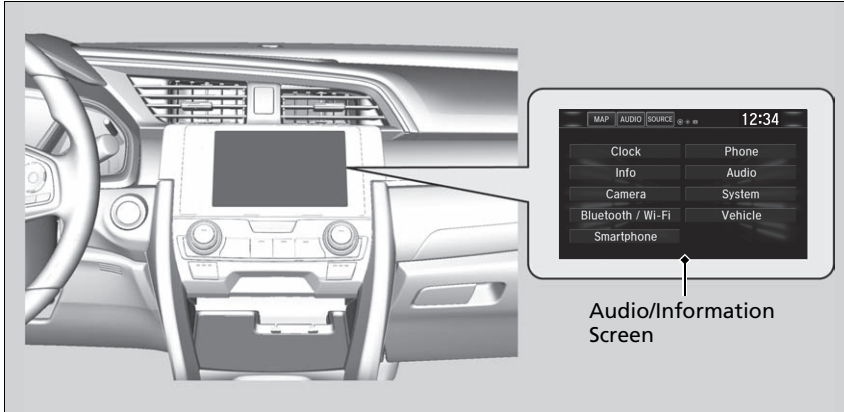

*1: Models with the keyless access system have an **ENGINE START/STOP** button instead of an ignition switch.

▶▶ Customized Features

When you customize settings:

- Make sure that the vehicle is at a complete stop.

Continuously variable transmission models

- Shift to .

Manual transmission models

- Set the parking brake.

To customize other features, select **Settings**.

▶ **List of customizable options** P. 375

Models with Display Audio

■ Customization flow

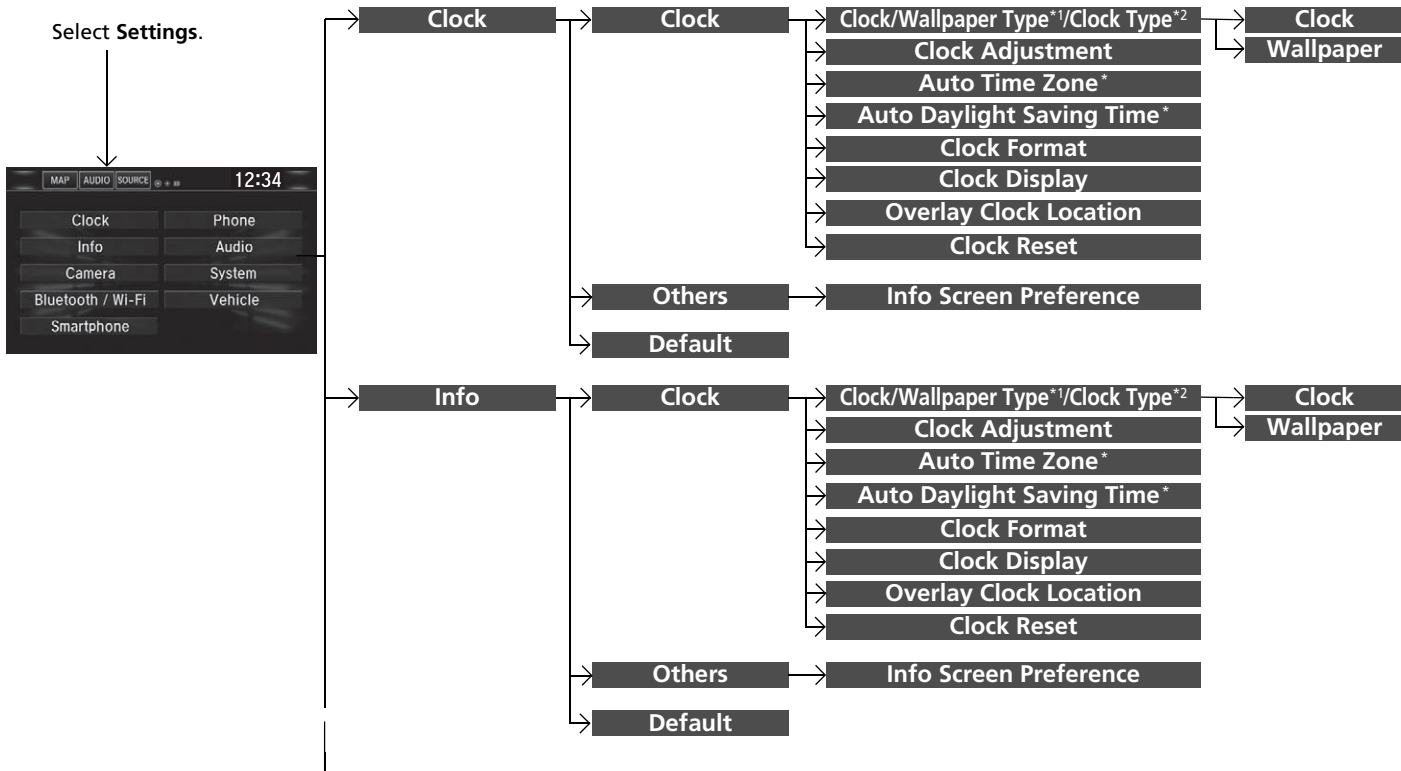

*1 : Does not appear when you change the screen interface design.

*2 : Appears only when you change the screen interface design.

* Not available on all models

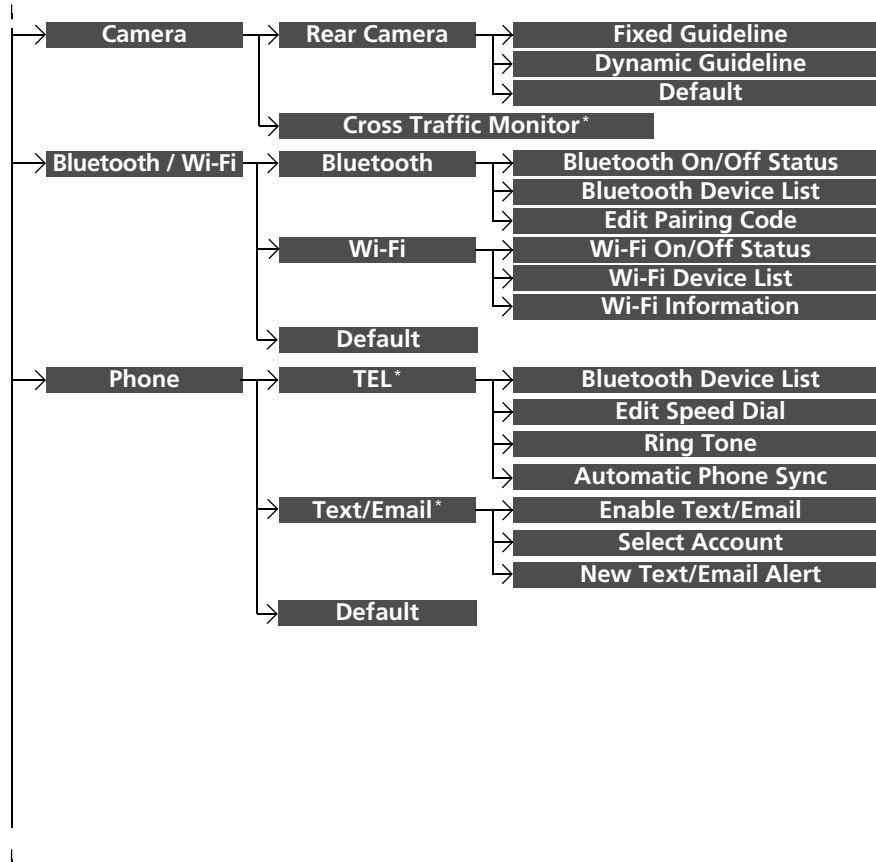

* Not available on all models

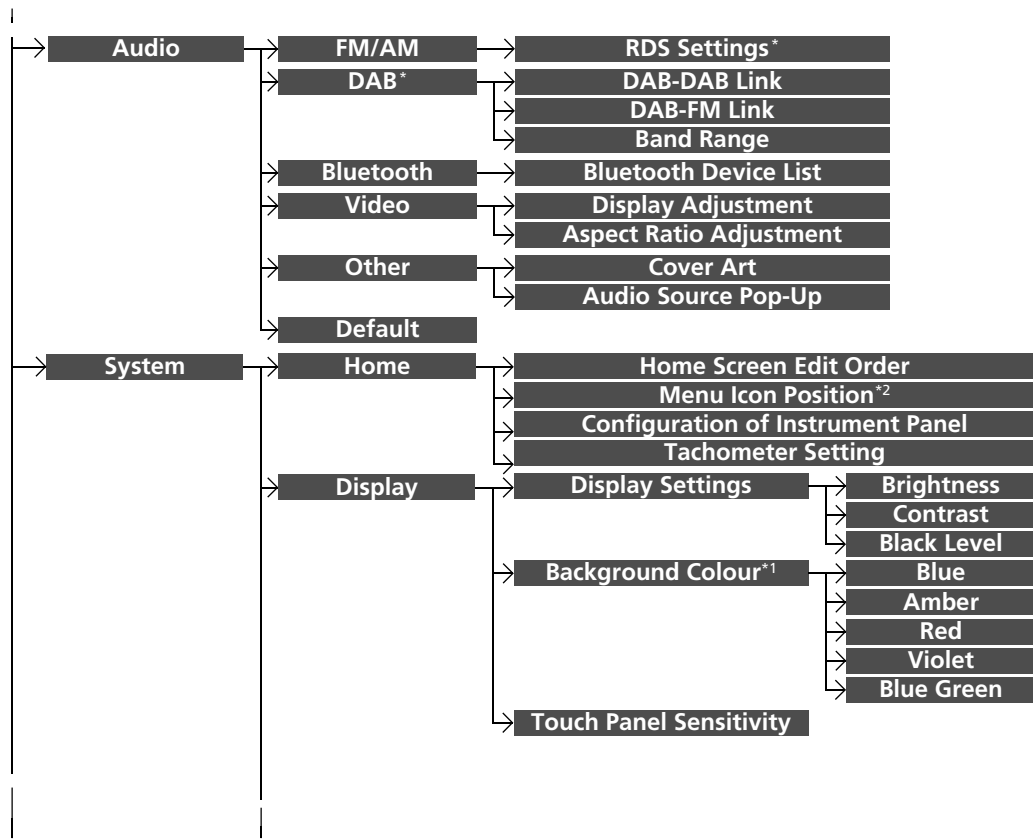

*1 : Does not appear when you change the screen interface design.

*2 : Appears only when you change the screen interface design.

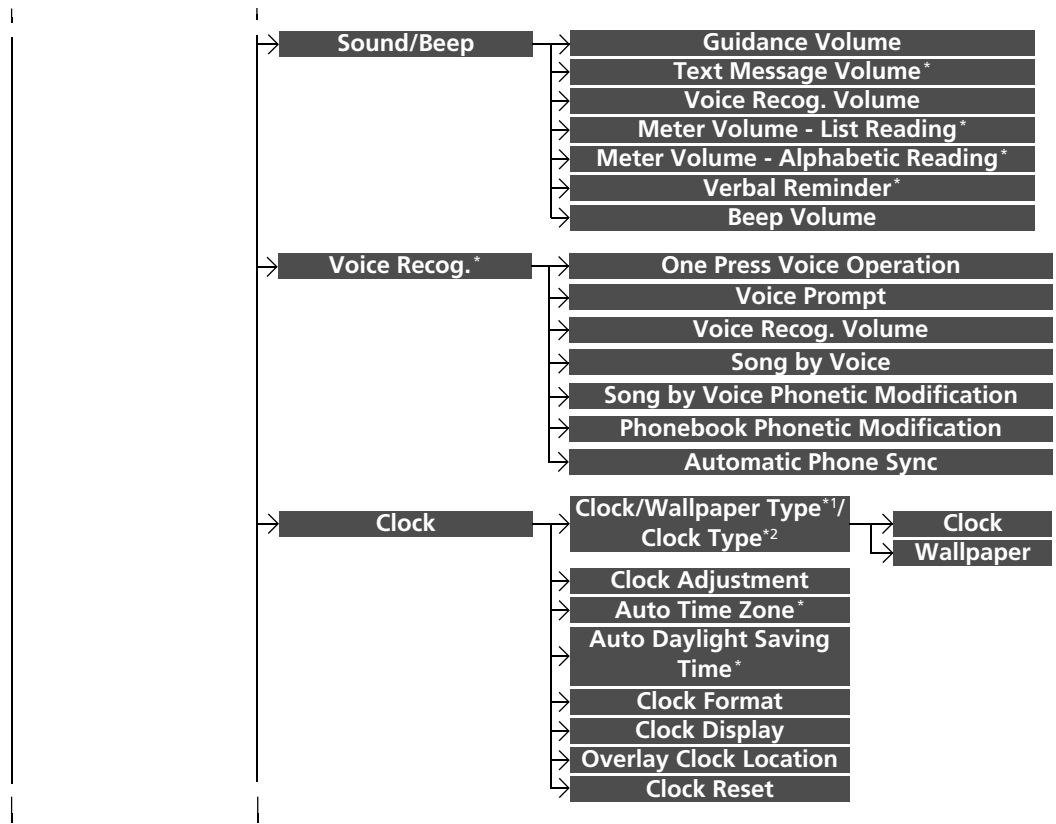

*1: Does not appear when you change the screen interface design.

*2: Appears only when you change the screen interface design.

* Not available on all models

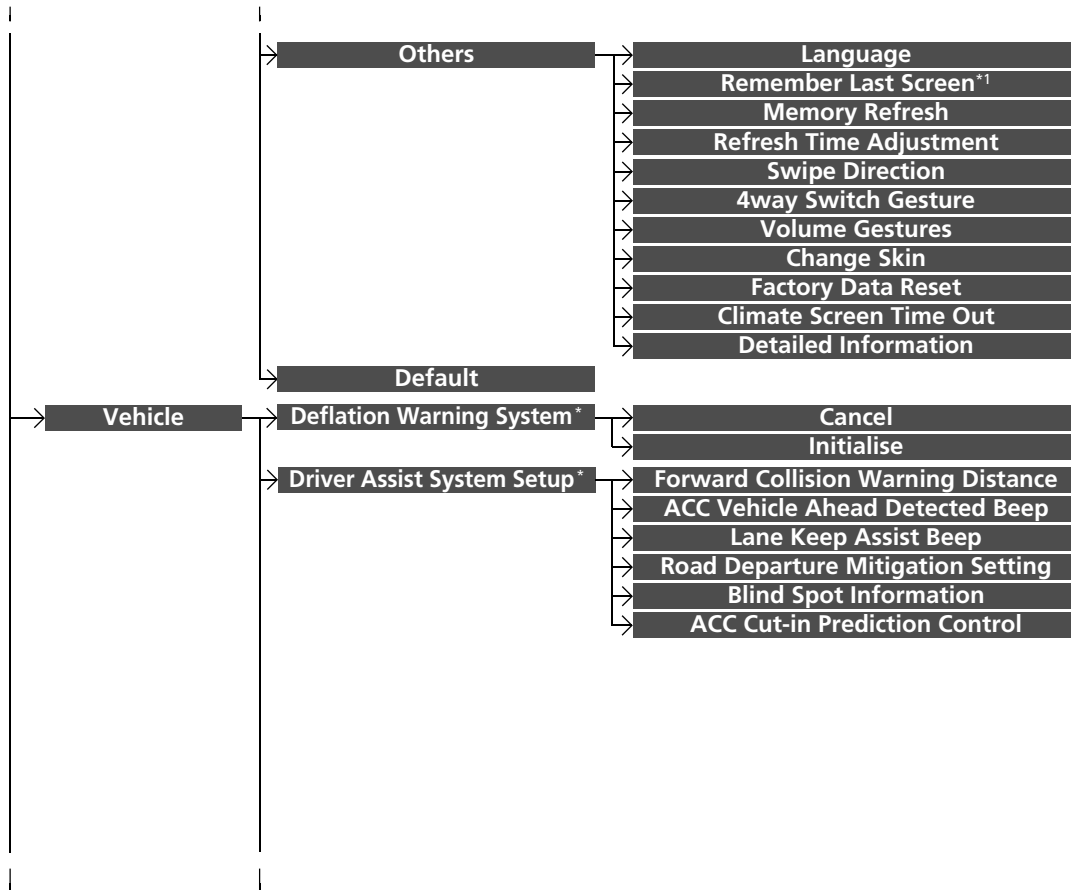

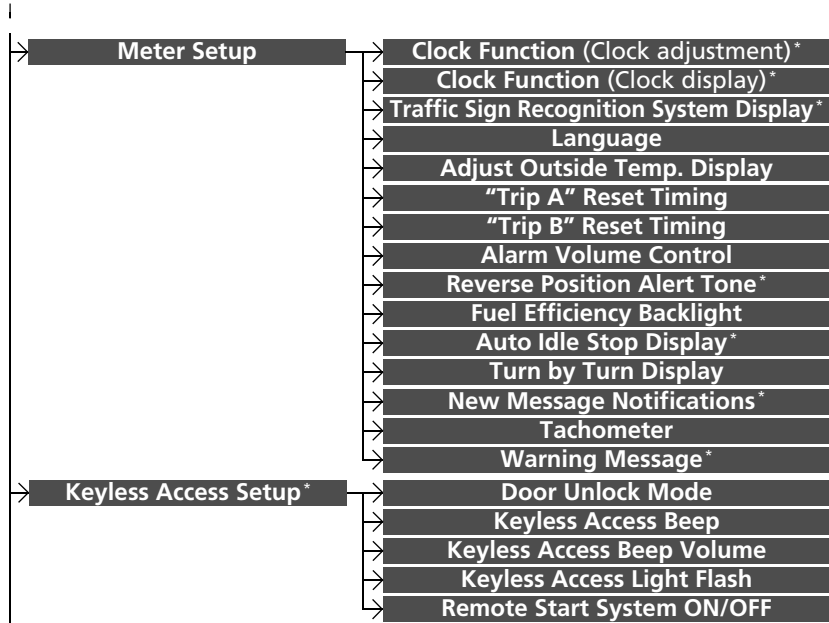

* Not available on all models

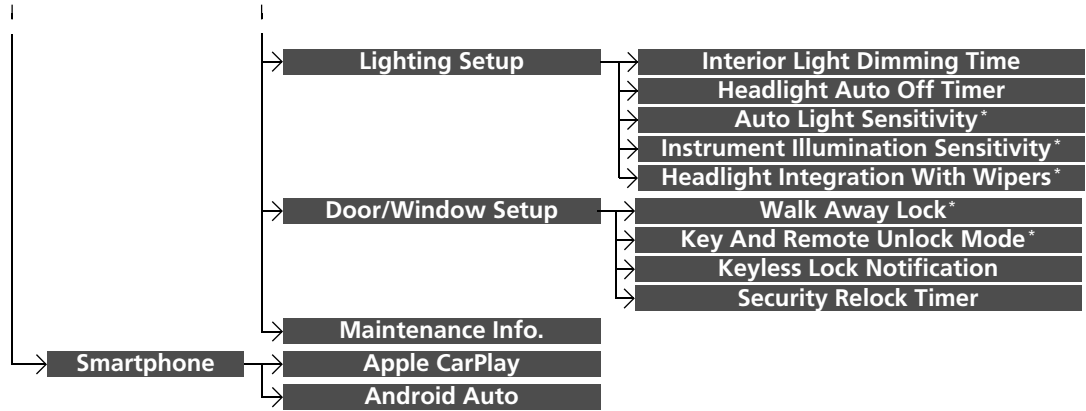

Models with Display Audio

■ List of customizable options

Setup Group	Customizable Features	Description	Selectable Settings	
Clock	Clock/Wallpaper Type ^{*1} /Clock Type ^{*2}	Clock Wallpaper		
	Clock Adjustment			
	Auto Time Zone [*]			
	Auto Daylight Saving Time [*]			
	Clock Format		See Info on P. 376	
	Clock Display			
	Overlay Clock Location			
	Clock Reset			
	Others	Info Screen Preference		
	Default		Cancels/Resets all customized items in the Clock settings group as default.	Yes/No

*1: Does not appear when you change the screen interface design.

*2: Appears only when you change the screen interface design.



* Not available on all models

Setup Group	Customizable Features	Description	Selectable Settings	
Info	Clock/ Wallpaper Type^{*2/} Clock Type^{*3}	Clock	Changes the clock display type.	Analog/Digital^{*1/} Small Digital/Off
		Wallpaper	<ul style="list-style-type: none"> • Changes the wallpaper type. • Imports an image file for a new wallpaper. • Deletes an image file for a wallpaper. 	Blank/Galaxy^{*1/} Metallic
	Clock Adjustment		Adjusts Clock.	—
	Auto Time Zone[*]		Automatically adjusts the clock when driving through different time zones.	On^{*1/}Off
	Auto Daylight Saving Time[*]		Selects On to have the GPS automatically adjust the clock to daylight savings time. Select Off to cancel this function.	On^{*1/}Off
	Clock Format		Selects the digital clock display from 12H to 24H.	12H^{*1/}24H
	Clock Display		Selects whether the clock display comes on.	On^{*1/}Off
	Overlay Clock Location		Changes the clock display layout.	Right Upper^{*1/}Left Upper/Right Lower/ Left Lower/Off
	Clock Reset		Resets the clock settings to the factory default.	Yes/No

*1:Default Setting

*2:Does not appear when you change the screen interface design.

*3:Appears only when you change the screen interface design.

Setup Group	Customizable Features	Description	Selectable Settings	
Info	Others Info Screen Preference	Selects the top menu when the  (display/information) button is pressed. <ul style="list-style-type: none"> • Info Top- A brief menu pops up. • Info Menu- A full menu pops up. • Off- A menu does not pop up. 	Info Top/Info Menu*¹/Off	
	Default	Cancels/Resets all customized items in the Info settings group as default.	Yes/No	
Camera	Rear Camera	Fixed Guideline	Selects whether the fixed guidelines come on the rear camera monitor.  Multi-View Rear Camera * P. 589	On*¹/Off
		Dynamic Guideline	Selects whether the guidelines adjust to the movement of the steering wheel.  Multi-View Rear Camera * P. 589	On*¹/Off
		Default	Cancels/Resets all customized items in the Rear Camera setting group as default.	Yes/No
		Cross Traffic Monitor *	Turns on and off the cross traffic monitor.	On*¹/Off

* 1:Default Setting

Setup Group	Customizable Features	Description	Selectable Settings
Bluetooth / Wi-Fi	Bluetooth On/Off Status	Changes the <i>Bluetooth</i> ® status.	On**/Off
	Bluetooth Device List	Pairs a new phone to HFT, edits or deletes a paired phone. ▶ Phone Setup P. 422	—
	Edit Pairing Code	Edits a pairing code. ▶ To change the pairing code setting P. 423	Random/Fixed*1
	Wi-Fi On/Off Status	Changes the Wi-Fi mode.	On/Off*1
	Wi-Fi Device List	Connects, disconnects, or deletes the Wi-Fi device.	—
	Wi-Fi Information	Shows the Wi-Fi information of the head unit.	—
Default	Cancels/Resets all customized items in the Bluetooth / Wi-Fi group as default.		Yes/No

*1:Default Setting

Setup Group	Customizable Features	Description	Selectable Settings
Phone	Bluetooth Device List	Pairs a new phone to HFT, connects or disconnects a paired phone. ▶ Phone Setup P. 422	—
	Edit Speed Dial	Edits, adds or deletes a speed dial entry. ▶ Speed Dial P. 428	—
	Ring Tone	Selects the ring tone.	Fixed/Mobile Phone * ¹
	Automatic Phone Sync	Sets a phonebook and call history data to be automatically imported when a phone is paired to HFT.	On * ¹ / Off
	Enable Text/Email	Turns the text/e-mail message function on and off.	On * ¹ / Off
	Select Account	Selects a text or e-mail message account.	—
	New Text/Email Alert	Selects whether a pop-up alert comes on the screen when HFT receives a new text/e-mail message.	On/Off * ¹
Default	Cancels/Resets all customized items in the Phone settings group as default.	Yes/No	

*1:Default Setting

* Not available on all models

Setup Group	Customizable Features	Description	Selectable Settings
<div style="background-color: #333; color: white; padding: 2px; display: inline-block;">FM/AM mode</div> FM/AM	RDS Settings*	TA Information	Turns on and off the traffic information. On/Off*¹
		News	Turns on and off to automatically to tune to the news programme. On/Off*¹
		REG	Turns on and off to keep the same stations within that region even if the signal gets weak. On*¹/Off
		AF	Turns on and off to automatically change the frequency of the same programme as you enter different regions. On*¹/Off
Audio	DAB-DAB Link	Selects whether the system automatically searches for the same station from Ensembles, and switches to it. On*¹/Off	
	<div style="background-color: #333; color: white; padding: 2px; display: inline-block;">DAB mode</div> DAB	DAB-FM Link	Selects whether the system finds the same station from an FM band, and automatically switches the band. On*¹/Off
	Band Range	Selects specific bands to reduce the time to update the lists, and search for a station. BOTH*¹/ BAND III/ L-BAND	
<div style="background-color: #333; color: white; padding: 2px; display: inline-block;">Bluetooth® mode</div> Bluetooth	Bluetooth Device List	Pairs a new phone to HFT, edits or deletes a paired phone. ☞ Phone Setup P. 422	—

*1:Default Setting

* Not available on all models

Setup Group	Customizable Features	Description	Selectable Settings	
Audio <div style="border: 1px solid black; padding: 2px; display: inline-block;">USB or HDMI™ mode</div> Video	Display Adjustment	Brightness	See System on P. 383	
		Display		Contrast
				Black Level
	Colour	Colour	Changes the colour of the audio/information screen.	—
		Tint	Changes the tint of the audio/information screen.	—
Aspect Ratio Adjustment		Selects the display mode with a different aspect ratio from Original (only USB), Normal , Full and Zoom .	Original *1 (only USB)/ Normal / Full *1/ Zoom	

*1:Default Setting

Setup Group	Customizable Features	Description	Selectable Settings	
Audio	iPod or USB mode [Your selected media] Cover Art	Turns the cover art display on and off.	On* ¹ /Off	
	Audio Source Pop-Up	Selects whether the list of selectable audio source comes on when Audio is selected on the home screen.	On/Off* ¹	
	Default	Cancels/Resets all customized items in the Audio settings group as default.	Yes/No	
System	Home	Home Screen Edit Order	Changes the home screen icon layout.	—
		Menu Icon Position ²	Changes the position of the menu icons on the Audio , Phone , and Info screen.	—
		Configuration of Instrument Panel	Changes the Instrument Panel screen icon layout.	—
		Tachometer Setting	Turns on and off the tachometer display.	On* ¹ /Off

*1:Default Setting

*2:Appears only when you change the screen interface design.



Setup Group	Customizable Features	Description	Selectable Settings		
System	Display	Brightness	Changes the brightness of the audio/information screen.	—	
		Display Settings	Contrast	Changes the contrast of the audio/information screen.	—
			Black Level	Changes the black level of the audio/information screen.	—
		Background Colour*²	Changes the background colour of the audio/information screen.	Blue/Amber/Red/Violet/Blue Green*¹ RS grade models Blue/Amber/Red*¹/Violet/Blue Green	
		Touch Panel Sensitivity	Sets the sensitivity of the touch panel screen.	High/Low*¹	
	Sound/ Beep	Guidance Volume	Changes the sound volume. Adjusts the guidance volume of the navigation system.	00~6*¹~11	
		Text Message Volume*	Changes the text/e-mail message reading volume.	1~6*¹~11	
Voice Recog. Volume		Changes the volume of the voice prompt.	1~6*¹~11		

*1: Default Setting

*2: Does not appear when you change the screen interface design.

* Not available on all models

Continued

Setup Group	Customizable Features	Description	Selectable Settings
Sound/ Beep	Meter Volume - List Reading*	Changes the list reading volume.	00~6*¹~11
	Meter Volume - Alphabetic Reading*	Changes the alphabetic reading volume.	00~6*¹~11
	Verbal Reminder*	Turns the verbal reminders on and off.	On*¹/Off
	Beep Volume	Changes the beep volume.	Off/1/2*¹/3
System	One Press Voice Operation	Changes the setting of the  (Talk) button operation when using the voice operation.	On*¹/Off
	Voice Prompt	Turns the voice prompt on and off.	On*¹/Off
	Voice Recog. Volume	Changes the volume of the voice prompt.	01~06*¹~11
	Song by Voice	Turns the Song By Voice™ on and off.	On*¹/Off
Voice Recog.*	Song by Voice Phonetic Modification	Modifies a voice command for music stored in the system or an iPod/iPhone.  Phonetic Modification P. 326	—
	Phonebook Phonetic Modification	Modifies a voice command for the phonebook.  Phonebook Phonetic Modification* P. 431	—
	Automatic Phone Sync	Sets phonebook and call history data to be automatically imported when a phone is paired to HFT.	On/Off

*1:Default Setting

* Not available on all models

Setup Group	Customizable Features	Description	Selectable Settings
System	Clock/Wallpaper Type ^{*1} / Clock Type ^{*2}	Clock Wallpaper	
	Clock Adjustment		
	Auto Time Zone [*]		
	Auto Daylight Saving Time [*]		See Info on P. 376
	Clock Format		
	Clock Display		
	Overlay Clock Location		
	Clock Reset		
Others	Language	Change the display language.	<p>Turkish models English (United Kingdom)^{*3} or Turkish^{*3} See other selectable languages on the screen.</p> <p>Except Turkish models English (United Kingdom)^{*3} See other selectable languages on the screen.</p>

*1: Does not appear when you change the screen interface design.

*2: Appears only when you change the screen interface design.

*3: Default Setting

* Not available on all models

Setup Group	Customizable Features	Description	Selectable Settings
System Others	Remember Last Screen *2	Selects whether the device remembers the last screen.	On/Off *1
	Memory Refresh	Turns on the audio system automatically and restores the fragmentation of a memory when the power mode is in VEHICLE OFF (LOCK).	On *1/Off
	Refresh Time Adjustment	Sets the time for Memory Refresh .	—
	Swipe Direction	Sets the vertical swipe direction on the audio remote controls.	Normal *1/Invert
	4way Switch Gesture	Turns the vertical swipe direction on the audio remote controls on or off.	On *1/Off
	Volume Gestures	Turns the volume swipe direction on the audio remote controls on or off.	On *1/Off
	Change Skin	Changes the screen interface design.	Yes/No
	Factory Data Reset	Resets all the settings to their factory default.  Defaulting All the Settings P. 393	Yes/No

*1:Default Setting

*2:Does not appear when you change the screen interface design.

Setup Group	Customizable Features	Description	Selectable Settings
System	Others	Climate Screen Time Out	Changes the length of time the climate control display stays on when you press the CLIMATE button.
			Never/5 Seconds/ 10 Seconds^{*1}/ 20 Seconds
	Detailed Information	Displays the details of the head unit and operating system information.	—
	Default	Cancels/Resets all customized items in the System group as default.	Yes/No

*1:Default Setting

Setup Group	Customizable Features	Description	Selectable Settings
Vehicle	Driver Assist System Setup*		
	Deflation Warning System*	Initialises the deflation warning system.	Cancel*¹/Initialise
	Forward Collision Warning Distance	Changes Collision Mitigation Braking System (CMBS) alert distance.	Far/Normal*¹/Near
	ACC Vehicle Ahead Detected Beep	Causes the system to beep when the system detects a vehicle, or when the vehicle goes out of the ACC range.	On/Off*¹
	Lane Keep Assist Beep	Causes the system to beep when Lane Keeping Assist System (LKAS) is suspended.	On/Off*¹
	Road Departure Mitigation Setting	Changes the setting for the road departure mitigation system.	Normal/Delayed*¹/Warning Only/Early
	Blind Spot Information	Changes the setting for the blind spot information.	Audible And Visual Alert*¹/Visual Alert Only/Off
	ACC Cut-in Prediction Control	Turns the ACC cut-in prediction control feature on and off.	On*¹/Off

*1:Default Setting

Setup Group	Customizable Features	Description	Selectable Settings
Vehicle Meter Setup	Clock Function (Clock adjustment)*	Adjusts the time.	—
	Clock Function (Clock display)*	Sets time display 12 hour or 24 hour.	12h^{*1}/24h/Off
	Traffic Sign Recognition System Display*	Selects whether the traffic sign small icons come on.	On^{*1}/Off
	Language	Changes the displayed language on the driver information interface.	<p>Israeli, Turkish, and except Middle Eastern models</p> <p>English^{*1}/German/Italian/French/Spanish/Portuguese/Dutch/Danish/Swedish/Norwegian/Finnish/Russian/Polish/Turkish</p> <p>Middle Eastern except Israeli and Turkish models</p> <p>Arabic^{*1}/English</p>
	Adjust Outside Temp. Display	Adjusts the temperature reading by a few degrees.	-3°C ~ ±0°C^{*1} ~ +3°C
	“Trip A” Reset Timing	Changes the setting of how to reset trip meter A and average fuel economy A.	When Refueled/When Ignition Is Turned Off/Manual Reset^{*1}

*1:Default Setting

* Not available on all models

Setup Group	Customizable Features	Description	Selectable Settings
Vehicle Meter Setup	"Trip B" Reset Timing	Changes the setting of how to reset trip meter B and average fuel economy B.	When Refueled/When Ignition Is Turned Off/Manual Reset^{*1}
	Alarm Volume Control	Changes the alarm volume, such as buzzers, warnings, turn signal sound, and so on.	Max/Mid^{*1}/Min
	Reverse Position Alert Tone[*]	Causes the beeper to sound when you move to R.	On^{*1}/Off
	Fuel Efficiency Backlight	Turns the ambient meter feature on and off.	On^{*1}/Off
	Auto Idle Stop Display[*]	Selects whether the Auto Idle Stop display comes on.	On^{*1}/Off
	Turn by Turn Display	Used to select whether the turn-by-turn display comes on during the route guidance.	On^{*1}/Off
	New Message Notifications[*]	Used to select whether a pop-up alert comes on the screen when HFT receives a new text/e-mail message.	On^{*1}/Off
	Tachometer	Selects whether the tachometer comes on the driver information interface.	On^{*1}/Off
	Warning Message[*]	Selects whether the warning message comes on the driver information interface.	On/Off^{*1}

*1:Default Setting

Setup Group	Customizable Features	Description	Selectable Settings	
Vehicle	Door Unlock Mode	Changes which doors unlock when you grab the driver's door handle.	Driver Door Only^{*1}/All Doors	
	Keyless Access Setup[*]	Keyless Access Beep	Causes the beeper to sound when you unlock/lock the doors.	On^{*1}/Off
		Keyless Access Beep Volume	Changes the keyless access beep volume.	High^{*1}/Low
		Keyless Access Light Flash	Causes some exterior lights to flash when you unlock/lock the doors.	On^{*1}/Off
		Remote Start System ON/OFF	Turns the remote engine start feature on and off.	On^{*1}/Off
	Lighting Setup	Interior Light Dimming Time	Changes the length of time the interior lights stay on after you close the doors.	60sec/30sec^{*1}/15sec
		Headlight Auto Off Timer	Changes the length of time the exterior lights stay on after you close the driver's door.	60sec/30sec/15sec^{*1}/0sec
		Auto Light Sensitivity[*]	Changes the timing for the headlights to come on.	Max/High/Mid^{*1}/Low/Min
Instrument Illumination Sensitivity[*]		Changes the sensitivity of the brightness of the instrument panel when the headlight switch is in AUTO .	Max/High/Mid^{*1}/Low/Min	

*1:Default Setting

* Not available on all models

Setup Group	Customizable Features	Description	Selectable Settings
Vehicle	Lighting Setup	Headlight Integration With Wipers*	Used to automatically come on the headlights when the wipers are used several times within a certain number of intervals with the headlight switch is in AUTO . On*/Off
	Door/Window Setup	Walk Away Lock*	Changes the settings for the auto lock function when you walk away from the vehicle. On/Off*¹
		Key And Remote Unlock Mode*	Sets up the driver's door or all the doors to unlock on the first push of the remote. Driver Door Only*¹/All Doors
		Keyless Lock Notification	LOCK/UNLOCK- The exterior lights flash. LOCK (2nd push)- The beeper sounds. On*¹/Off
		Security Relock Timer	Changes the time it takes for the doors to relock and the security system to set after you unlock the vehicle without opening any door. 90sec/60sec/30sec*¹
	Maintenance Info.	Used to reset the engine oil life display when the maintenance service has been performed. —	
Smart-phone	Apple CarPlay	Sets up the Apple CarPlay connection. —	
	Android Auto	Sets up the Android Auto connection. —	

*1:Default Setting

Models with Display Audio

Defaulting All the Settings

Reset all the menu and customized settings as the factory defaults.

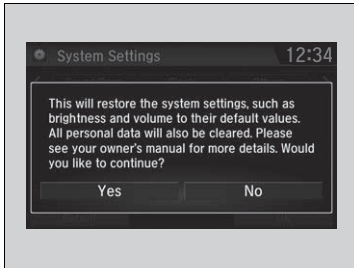

1. Select .
2. Select **Settings**.
3. Select **System**.
4. Select the **Others** tab.
5. Select **Factory Data Reset**.
 - ▶ A confirmation message appears on the screen.
6. Select **Yes** to reset the settings.
7. Select **Yes** again to reset the settings.
 - ▶ A confirmation message appears on the screen. Select **OK**.
 - ▶ After selecting **OK**, the system will reboot.

Defaulting All the Settings

When you transfer the vehicle to a third party, reset all settings to default and delete all personal data.

If you perform **Factory Data Reset**, it will reset the preinstalled apps to their factory default.

Hands-Free Telephone System

Hands-Free Telephone (HFT) System allows you to place and receive phone calls using your vehicle's audio system, without handling your mobile phone.

Models with colour audio system

Using HFT

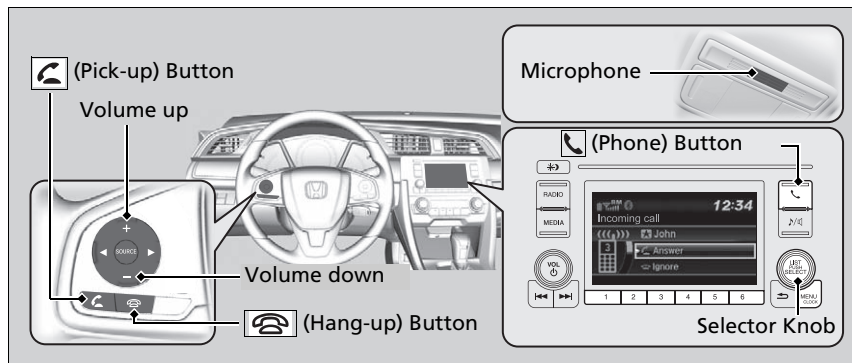

HFT Buttons



(Pick-up) button: Press to go directly to the phone screen or to answer an incoming call.

(Hang-up) button: Press to end a call or to cancel a command.

(Phone) button: Press to go directly to the phone screen.

Selector knob: Rotate  to select an item on the screen, then press .

Hands-Free Telephone System

Place your phone where you can get good reception.

To use HFT, you need a *Bluetooth*-compatible mobile phone. For a list of compatible phones, pairing procedures, and special feature capabilities, ask a dealer or your local Honda.

If you receive a call while using the audio system, the system resumes its operation after ending the call.

Up to 20 speed dial entries can be stored. If there is no entry in the system, Speed Dial is disabled.

Speed Dial P. 409

Up to 20 call histories can be stored. If there is no call history, Call History is disabled.

Bluetooth® Wireless Technology

The *Bluetooth*® word mark and logos are registered trademarks owned by *Bluetooth* SIG, Inc., and any use of such marks by Honda Motor Co., Ltd., is under license. Other trademarks and trade names are those of their respective owners.

HFT Limitations

An incoming call on HFT will interrupt the audio system when it is playing. It will resume when the call is ended.

HFT Status Display

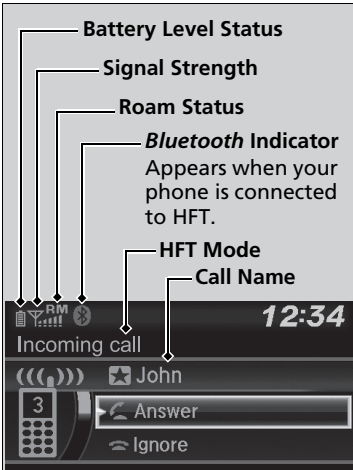

The audio/information screen notifies you when there is an incoming call.

▣ HFT Status Display

The information that appears on the audio/information screen varies between phone models.

You can change the system language.

▣ **Customized Features** P. 359

HFT Menu

The ignition switch must be in ACCESSORY **I** or ON **II** to use HFT.*1

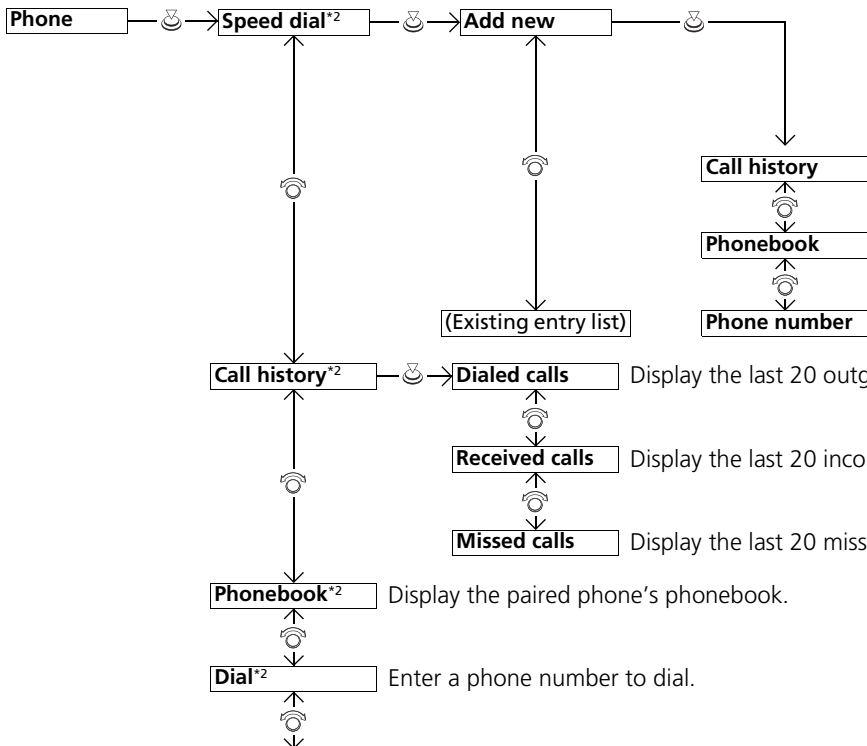
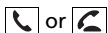

▶▶ HFT Menu

To use HFT, you must first pair your *Bluetooth*-compatible mobile phone to the system while the vehicle is parked.

Select a phone number from the call history to store as a speed dial number.

Select a phone number from the phonebook to store as a speed dial number.

Enter a phone number to store as a speed dial number.

Display the last 20 outgoing calls.

Display the last 20 incoming calls.

Display the last 20 missed calls.

Display the paired phone's phonebook.

Enter a phone number to dial.

*1: Models with the keyless access system have an **ENGINE START/STOP** button instead of an ignition switch.
 *2: Appears only when a phone is connected to HFT.

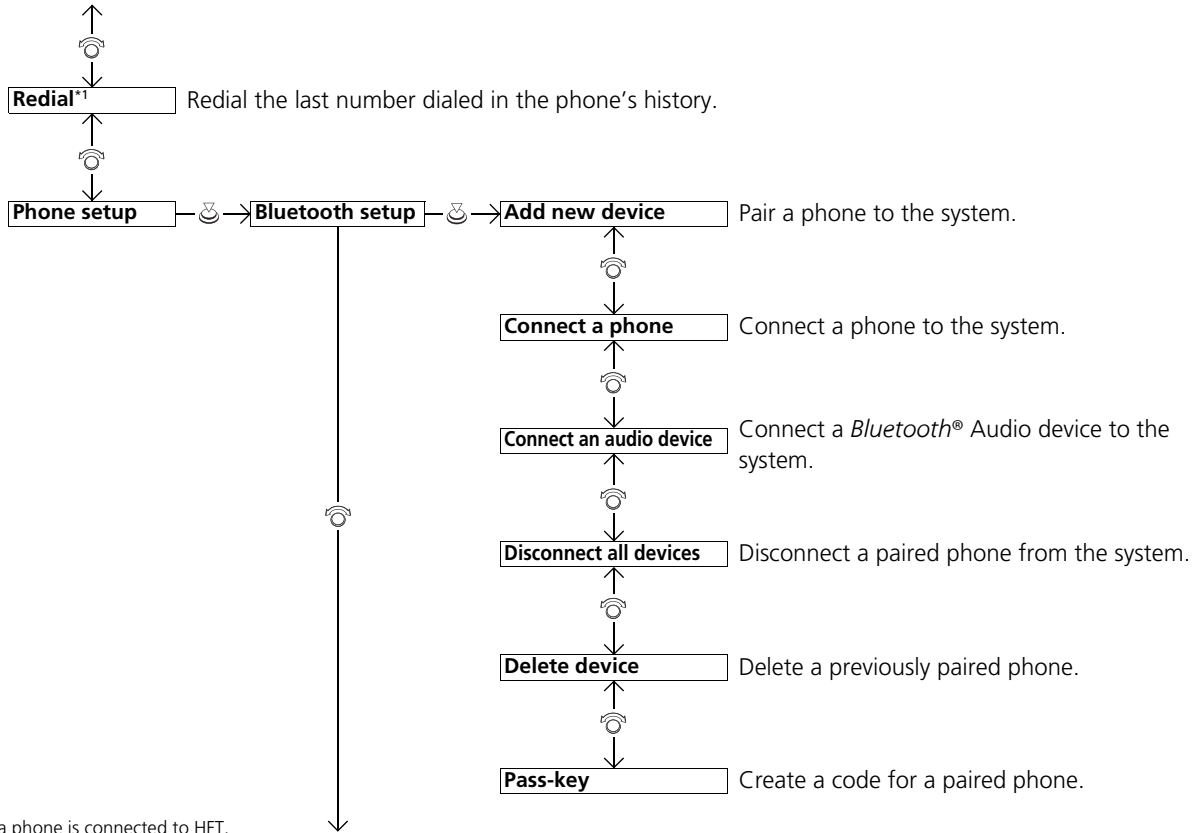

*1: Appears only when a phone is connected to HFT.

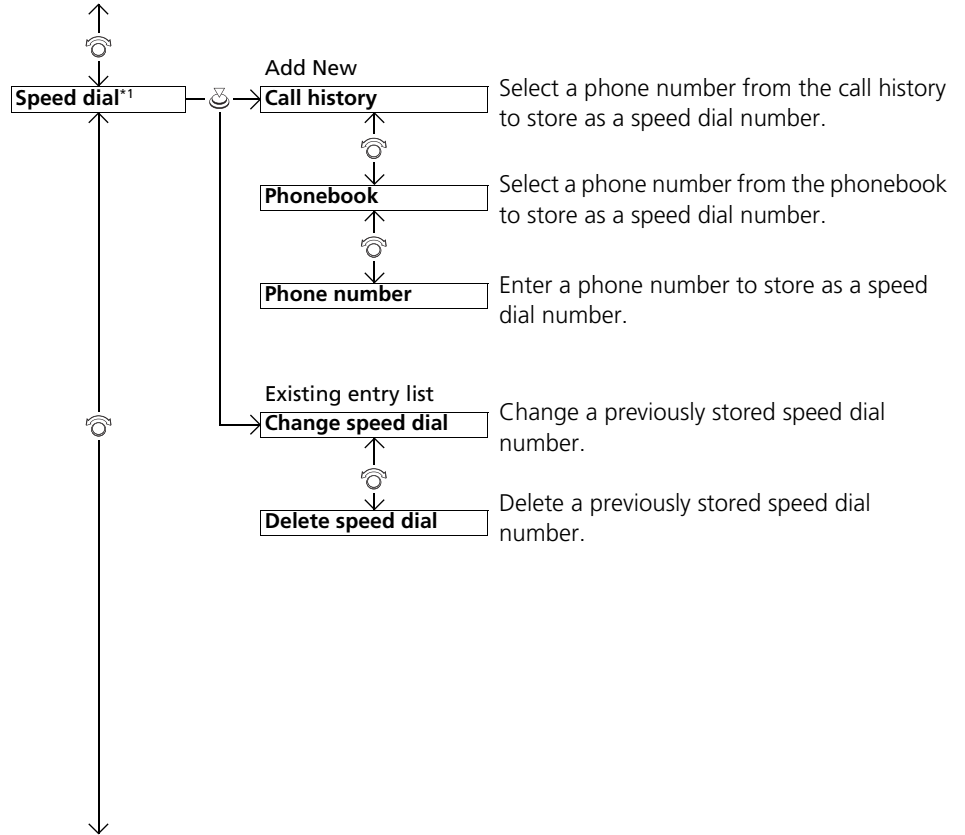

*1: Appears only when a phone is connected to HFT.

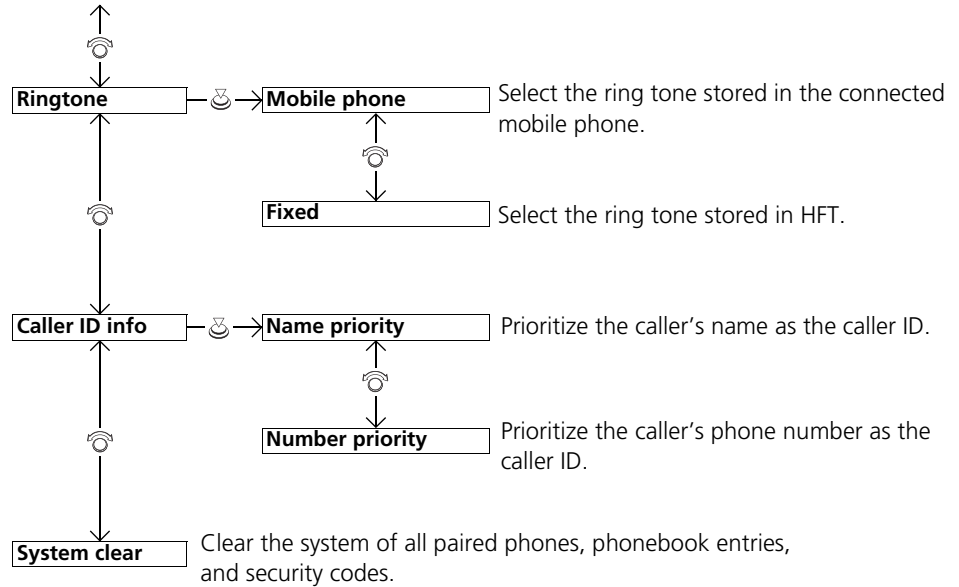

Phone Setup



■ To pair a mobile phone (No phone has been paired to the system)

1. Press the button or the button.
2. Rotate to select **Yes**, then press .
3. Make sure your phone is in search or discoverable mode, then press .
 - ▶ HFT automatically searches for a *Bluetooth*® device.
4. When your phone appears on the list, select it by pressing .
 - ▶ If your phone does not appear, select **Phone not found?** and search for *Bluetooth*® devices using your phone. From your phone, select **Honda HFT**.
5. The system gives you a pairing code on the audio/information screen.
 - ▶ Confirm if the pairing code on the screen and your phone match. This may vary by phone.
6. A notification appears on the screen if pairing is successful.

▶▶ Phone Setup

Your *Bluetooth*-compatible phone must be paired to HFT before you can make and receive hands-free calls.

Phone Pairing Tips:

- You cannot pair your phone while the vehicle is moving.
- Up to six phones can be paired.
- Your phone's battery may drain faster when it is paired to HFT.
- If your phone is not ready for pairing or not found by the system within three minutes, the system will time out and return to idle.





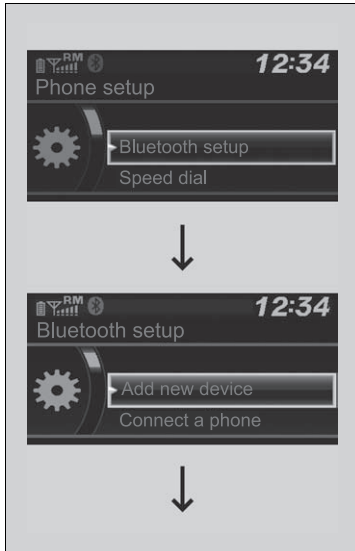

Once you have paired a phone, you can see it displayed on the screen with one or two icons on the right side.

These icons indicate the following:

- : The phone can be used with HFT.
- : The phone is compatible with *Bluetooth*® Audio.

■ **To pair a mobile phone (when a phone has already been paired to the system)**



1. Press the  button or the  button.
 - ▶ If a prompt appears asking to connect to a phone, select **No** and proceed with step 2.
2. Rotate  to select **Phone setup**, then press .
3. Rotate  to select **Bluetooth setup**, then press .
4. Rotate  to select **Add new device**, then press .
 - ▶ The screen changes to device list.

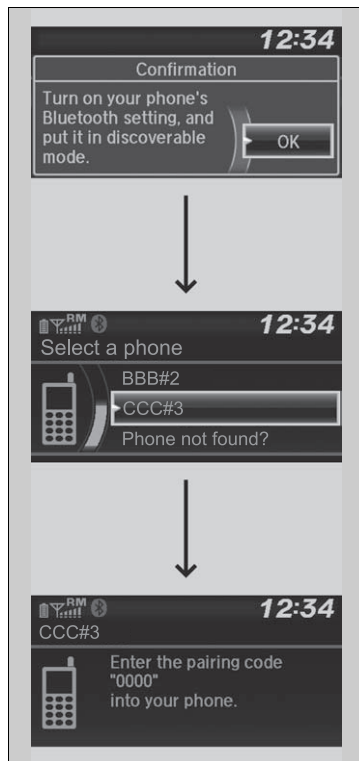







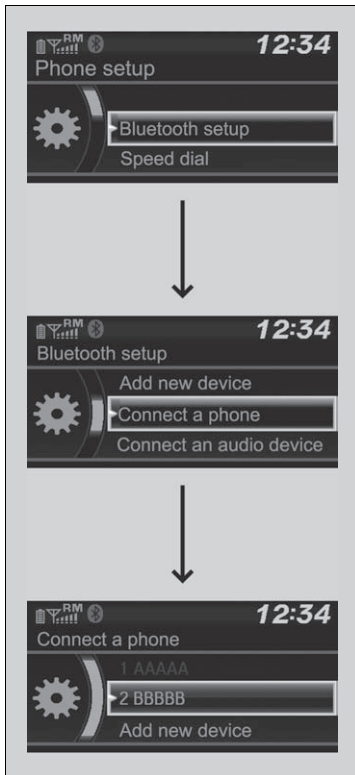



5. Make sure your phone is in search or discoverable mode, then press .
 - ▶ HFT automatically searches for a *Bluetooth*® device.

6. When your phone appears on the list, select it by pressing .
 - ▶ If your phone does not appear, select **Phone not found?** and search for *Bluetooth*® devices using your phone. From your phone, select **Honda HFT**.

7. The system gives you a pairing code on the audio/information screen.
 - ▶ Confirm if the pairing code on the screen and your phone match. This may vary by a phone.



■ To change the currently paired phone

1. Press the  button or the  button.
2. Rotate  to select **Phone setup**, then press .
3. Rotate  to select **Bluetooth setup**, then press .
4. Rotate  to select **Connect a phone**, then press .
 - ▶ The screen changes to a device list.
5. Rotate  to select a desired device name, then press .
 - ▶ HFT disconnects the connected phone and starts searching for another paired phone.

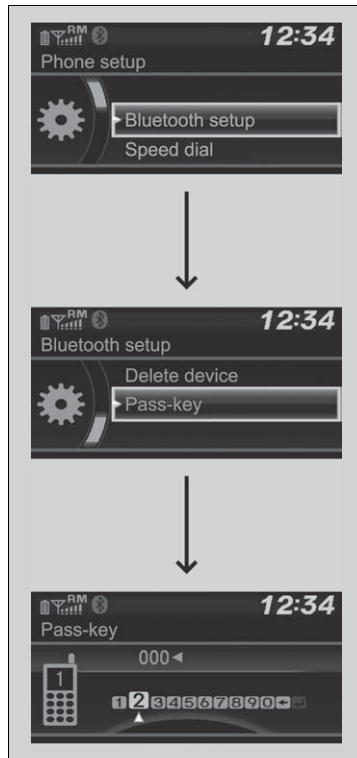

■ **To change the pairing code setting**

1. Press the button or the button.
2. Rotate to select **Phone setup**, then press .
3. Rotate to select **Bluetooth setup**, then press .
4. Rotate to select **Pass-key**, then press .
5. Input a new pairing code, then press .

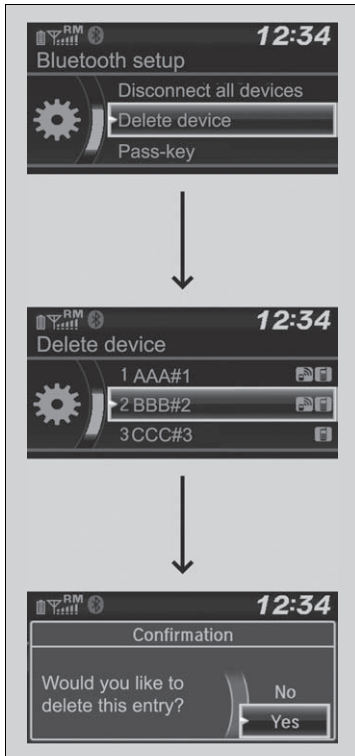

■ To delete a paired phone

1. Press the button or the button.
2. Rotate to select **Phone setup**, then press .
3. Rotate to select **Bluetooth setup**, then press .
4. Rotate to select **Delete device**, then press .
 - ▶ The screen changes to a device list.
5. Rotate to select a phone you want to delete, then press .
6. A confirmation message appears on the screen. Rotate to select **Yes**, then press .

■ Ring Tone

You can change the ring tone setting.



1. Press the button or the button.
2. Rotate to select **Phone setup**, then press .
3. Rotate to select **Ringtone**, then press .
4. Rotate to select **Mobile phone** or **Fixed**, then press .

■ Caller's ID Information

You can select a caller's information to be displayed when you have an incoming call.

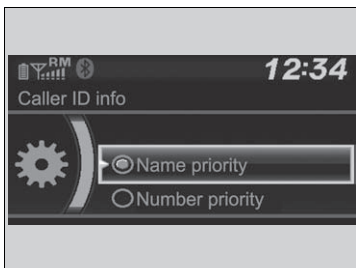

1. Press the button or the button.
2. Rotate to select **Phone setup**, then press .
3. Rotate to select **Caller ID info**, then press .
4. Rotate to select a mode you want, then press .

▶▶ Ring Tone

Mobile phone: For certain connected phones, the ring tone stored in the phone sounds from the speakers.

Fixed: The fixed ring tone sounds from the speakers.

▶▶ Caller's ID Information

Name priority: A caller's name is displayed if it is stored in the phonebook.

Number priority: A caller's phone number is displayed.

To Clear the System

Pairing codes, paired phones, all speed dial entries, all call history data, and all imported phonebook data are erased.

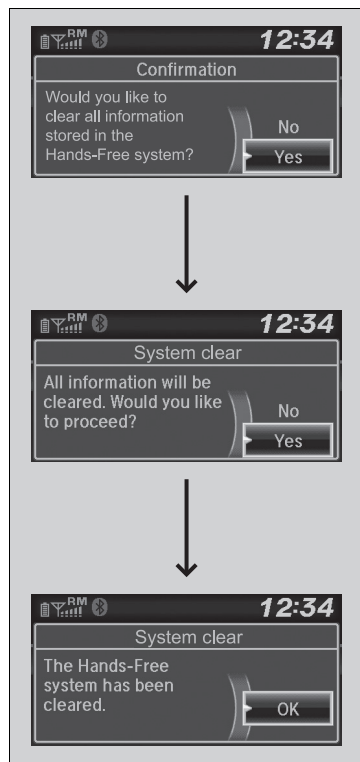

1. Press the button or the button.
2. Rotate to select **Phone setup**, then press .
3. Rotate to select **System clear**, then press .
4. Rotate to select **Yes**, then press .
5. A confirmation message appears on the screen. Rotate to select **Yes**, then press .
6. A notification appears on the screen. Press .

Continued

■ Automatic Import of Cellular Phonebook and Call History

When your phone is paired, the contents of its phonebook and call history are automatically imported to HFT.

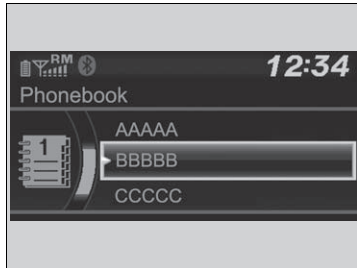

▶▶ Automatic Import of Cellular Phonebook and Call History

When you select a person from the list in the cellular phonebook, you can see up to three category icons. The icons indicate what types of numbers are stored for that name.

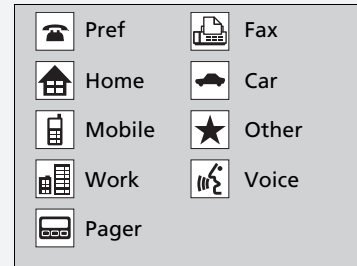

If a name has four or more numbers, ... appears instead of category icons.

On some phones, it may not be possible to import the category icons to HFT.

The phonebook is updated after every connection. Call history is updated after every connection or call.

Speed Dial

Up to 20 speed dial numbers can be stored per phone.

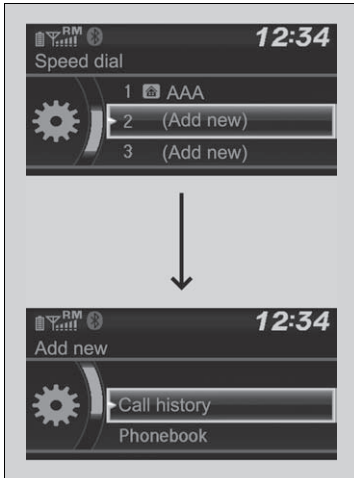

To store a speed dial number:

1. Press the button or the button.
2. Rotate to select **Speed dial**, then press .
3. Rotate to select **Add new**, then press .
4. Rotate to select a place to choose a number from, then press .
 - From **Call history**:
 - ▶ Select a number from the call history.
 - From **Phonebook**:
 - ▶ Select a number from the connected mobile phone's imported phonebook.
 - From **Phone number**:
 - ▶ Input the number manually.

Speed Dial

You can use the audio preset buttons during a call to store a speed dial number:

1. Press and hold the desired audio preset button during a call.
2. The contact information for the active call will be stored for the corresponding speed dial.

Continued

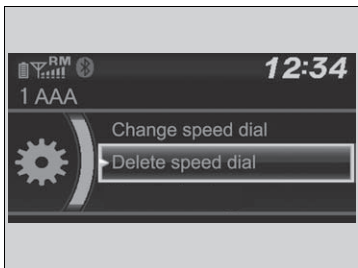
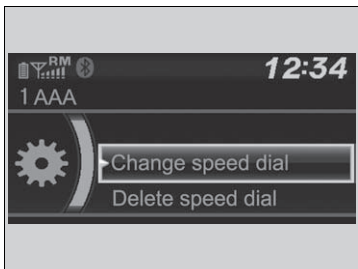

■ **To edit a speed dial**

1. Press the button or the button.
2. Rotate to select **Phone setup**, then press .
3. Rotate to select **Speed dial**, then press .
4. Select an existing speed dial entry.
5. Rotate to select **Change speed dial**, then press .
6. Select a new speed dial number, then press .

■ **To delete a speed dial number**

1. Press the button or the button.
2. Rotate to select **Phone setup**, then press .
3. Rotate to select **Speed dial**, then press .
4. Select an existing speed dial entry.
5. Rotate to select **Delete speed dial**, then press .
 - ▶ A confirmation message appears on the screen. Rotate to select **Yes**, then press .

Making a Call

You can make calls by inputting any phone number, or by using the imported phonebook, call history, speed dial entries, or redial.

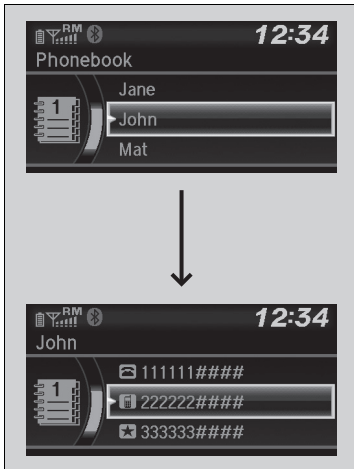
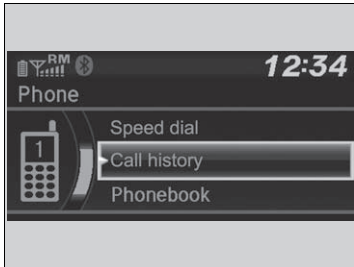

■ To make a call using the imported phonebook

When your phone is paired, the contents of its phonebook are automatically imported to HFT.

1. Press the button or the button.
 2. Rotate to select **Phonebook**, then press .
 3. The phonebook is stored alphabetically. Rotate to select the initial, then press .
 4. Rotate to select a name, then press .
 5. Rotate to select a number, then press .
- ▶ Dialing starts automatically.

▶▶ Making a Call

Once a call is connected, you can hear the voice of the person you are calling through the audio speakers.

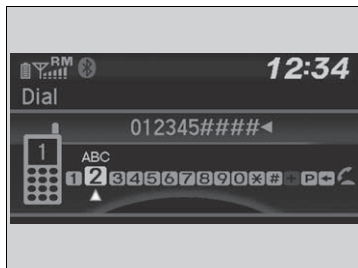

■ **To make a call using a phone number**

1. Press the button or the button.
2. Rotate to select **Dial**, then press .
3. Rotate to select a number, then press .
4. Rotate to select , then press .
 - ▶ Dialing starts automatically.



■ **To make a call using redial**

1. Press the button or the button.
2. Rotate to select **Redial**, then press .
 - ▶ Dialing starts automatically.

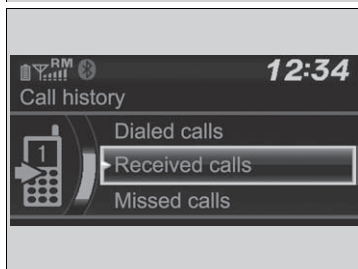

■ **To make a call using the call history**

Call history is stored by **Dialed calls**, **Received calls**, and **Missed calls**.

1. Press the button or the button.
2. Rotate to select **Call history**, then press .
3. Rotate to select **Dialed calls**, **Received calls**, or **Missed calls**, then press .
4. Rotate to select a number, then press .
 - ▶ Dialing starts automatically.

▶▶ To make a call using redial

Press and hold the button to redial the last number dialed in your phone's call history.

▶▶ To make a call using the call history

The call history appears only when a phone is connected to HFT, and displays the last 20 dialed, received, or missed calls.

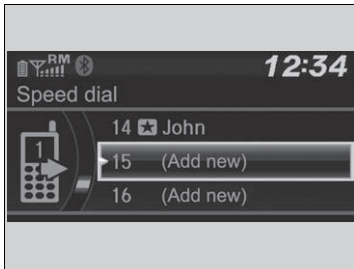

■ To make a call using a speed dial entry

1. Press the button or the button.
2. Rotate to select **Speed dial**, then press .
3. Rotate to select a number, then press .
 - ▶ Dialing starts automatically.

☒ To make a call using a speed dial entry

On the **Phone** screen, the first six speed dials on the list can be directly selected by pressing the corresponding audio preset buttons (**1-6**).

Select **Others** to view another paired phone's speed dial list.

■ Receiving a Call

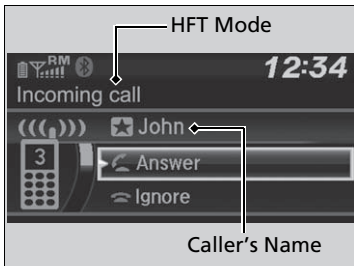

When there is an incoming call, an audible notification sounds and the **Incoming call** screen appears.

- Press the button to answer the call.
 Press the button to decline or end the call.

☒ Receiving a Call

Call Waiting

Press the button to put the current call on hold to answer the incoming call.

Press the button again to return to the current call.

Select **Ignore** to ignore the incoming call if you do not want to answer it.

Press the button if you want to hang up the current call.

You can select the icons on the audio/information screen instead of the and buttons. Rotate to select the icon, then press .

■ Options During a Call

The following options are available during a call.



Swap call: Put the current call on hold to answer the incoming call.

Mute: Mute your voice.

Transfer call: Transfer a call from HFT to your phone.

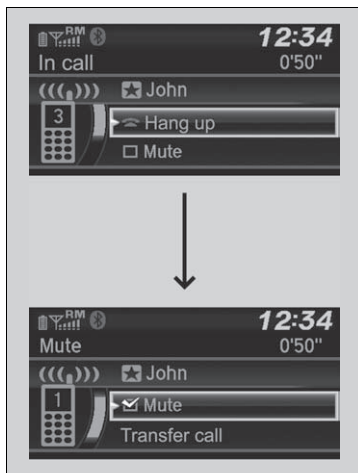
Dial tones: Send numbers during a call. This is useful when you call a menu-driven phone system.



1. To view the available options, press the  button.
 2. Rotate  to select the option, then press .
- ▶ The check box is checked when **Mute** is selected. Select **Mute** again to turn it off.

☞ Options During a Call

Dial tones: Available on some phones.

Hands-Free Telephone System

Models with Display Audio

Hands-Free Telephone (HFT) System allows you to place and receive phone calls using your vehicle's audio system, without handling your mobile phone.

Using HFT

HFT Buttons

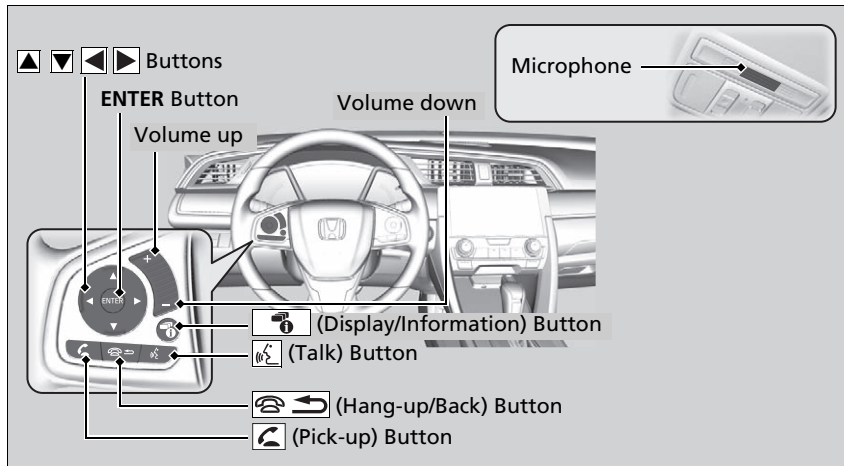

Hands-Free Telephone System

Place your phone where you can get good reception.

To use HFT, you need a *Bluetooth*-compatible mobile phone. For a list of compatible phones, pairing procedures, and special feature capabilities, ask a dealer or your local Honda.

To use the system, the **Bluetooth On/Off Status** setting must be **On**. If there is an active connection to Apple CarPlay, HFT is unavailable.

➤ **Customized Features P. 359**

Voice control tips

- Aim the vents away from the ceiling and close the windows, as noise coming from them may interfere with the microphone.
- Press the  button when you want to call a number using a stored voice tag. Speak clearly and naturally after a beep.
- If the microphone picks up voices other than yours, the command may be misinterpreted.
- To change the volume level, select the audio system's **VOL** (Volume) or use the remote audio controls on the steering wheel.

Up to five speed dial entries can be displayed among a total of 20 that can be entered.



➤ **Speed Dial P. 428**

Up to five previous calls can be displayed at a time among a total of 20 that can be entered. If there is no call history, Call History is disabled.

 **(Pick-up) button:** Press to go directly to the phone menu on the driver information interface, or to answer an incoming call.

 **(Hang-up/back) button:** Press to end a call, go back to the previous command, or cancel a command.



 **(Talk) button:** Press to access Voice Portal.

  **buttons:** Press to select an item displayed on the phone menu in the driver information interface.

ENTER button: Press to call a number listed in the selected item on the phone menu in the driver information interface.

 **(Display/information) button:** Select and press **ENTER** to display **Speed Dial**, **Call History**, or **Phonebook** on the phone menu in the driver information interface.

To go to the **Phone Menu** screen:

1. Select .
2. Select **Phone** to switch the display to the phone screen.
3. Select .

▶▶ Hands-Free Telephone System

Bluetooth[®] Wireless Technology

The *Bluetooth*[®] word mark and logos are registered trademarks owned by *Bluetooth* SIG, Inc., and any use of such marks by Honda Motor Co., Ltd., is under license. Other trademarks and trade names are those of their respective owners.

HFT Limitations

An incoming call on HFT will interrupt the audio system when it is playing. It will resume when the call is ended.

■ HFT Status Display

The audio/information screen notifies you when there is an incoming call.

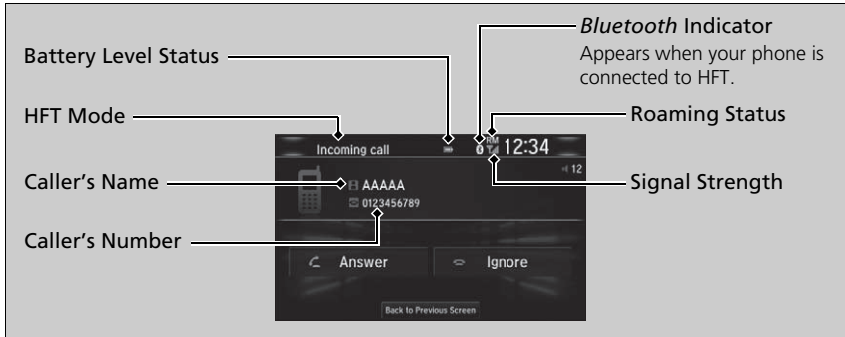

▣ HFT Status Display

The information that appears on the audio/information screen varies between phone models.

You can change the system language.

▣ **Customized Features** P. 359

HFT Menu

The ignition switch must be in ACCESSORY **I** or ON **II** to use HFT.*1

■ Phone Settings screen



1. Select .
2. Select **Settings**.
3. Select **Phone**.

▶▶ HFT Menu

To use HFT, you must first pair your *Bluetooth*-compatible mobile phone to the system while the vehicle is parked.

Features

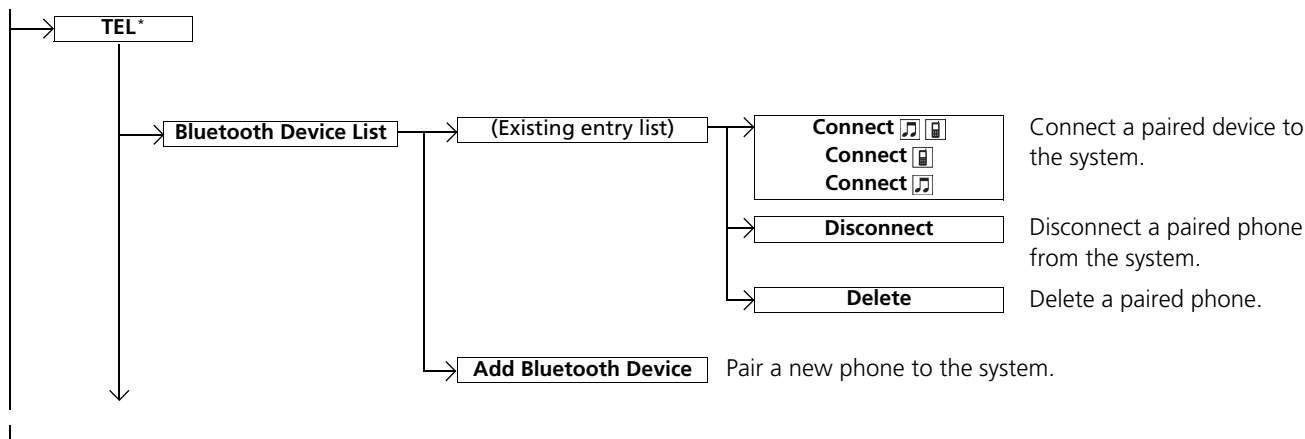

*1: Models with the keyless access system have an **ENGINE START/STOP** button instead of an ignition switch.

* Not available on all models

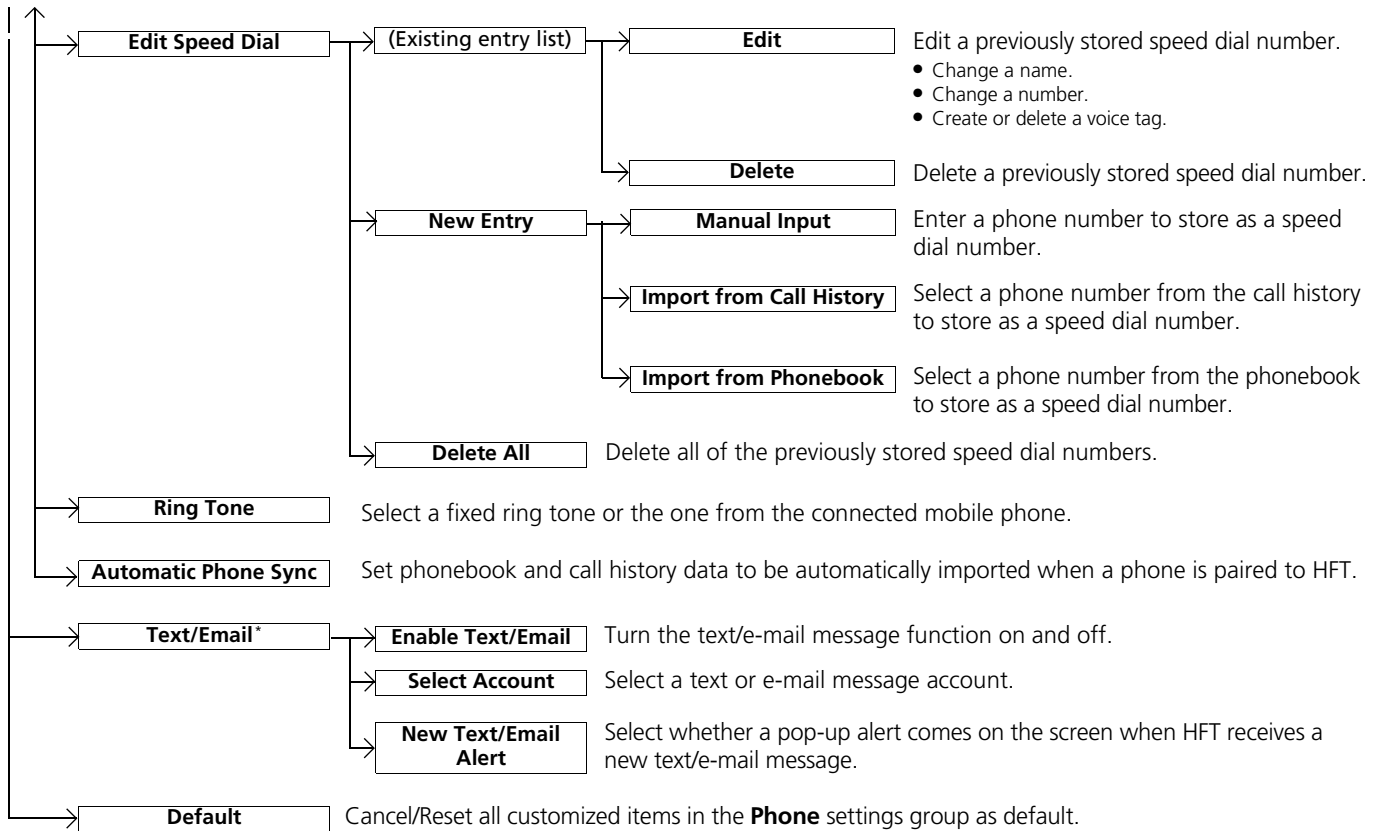

* Not available on all models

■ Phone Menu screen



1. Select .
2. Select **Phone**.
3. Select .

Features

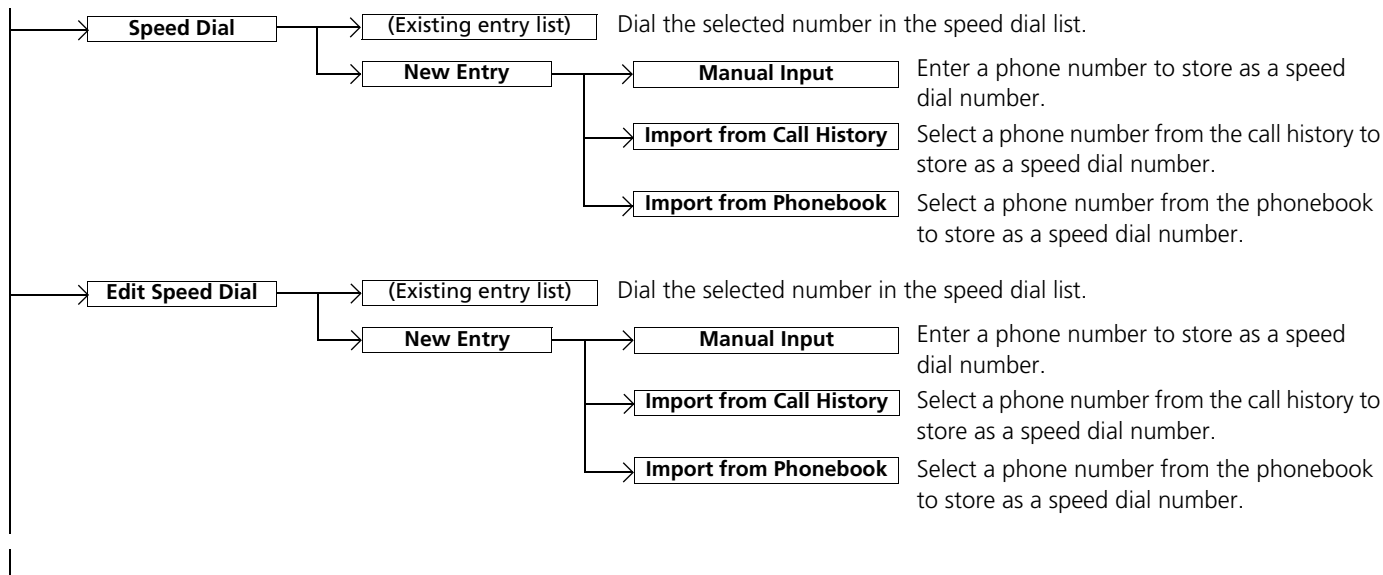

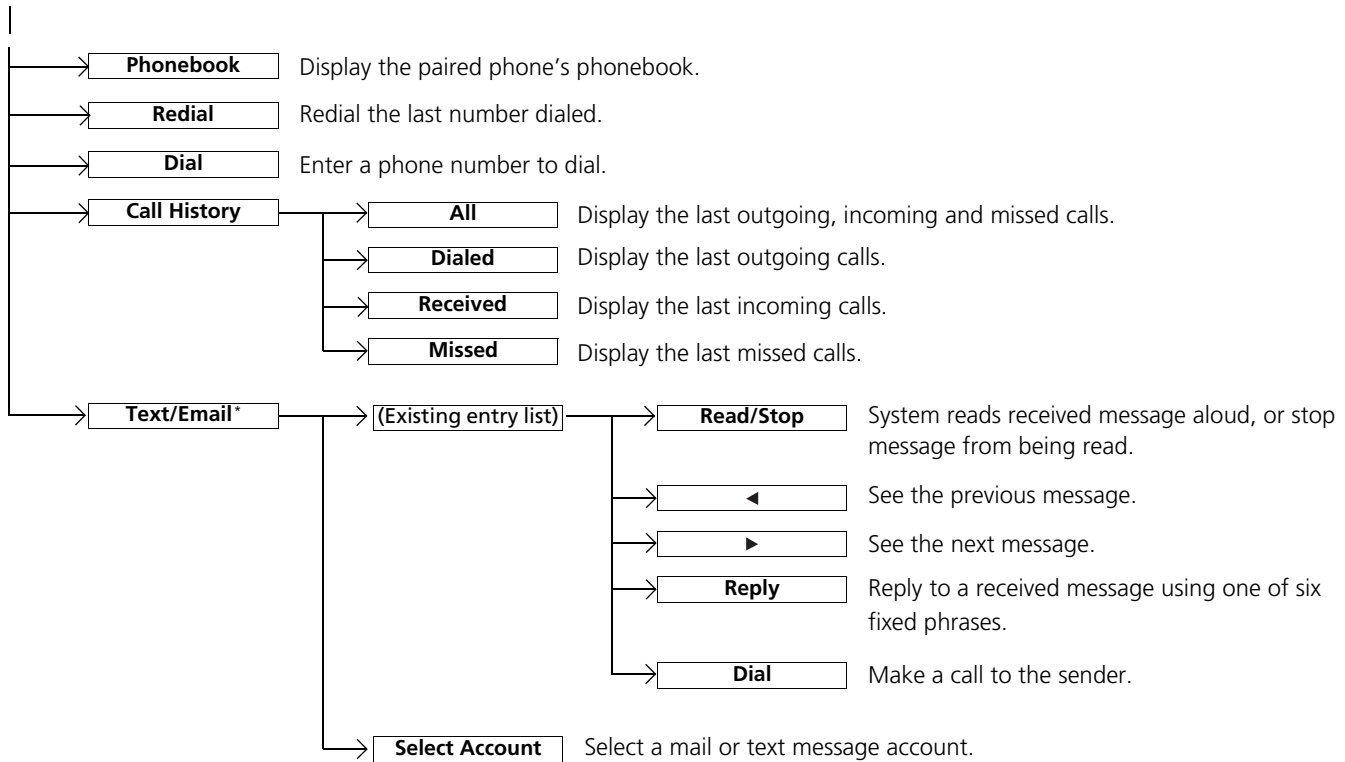

* Not available on all models

Phone Setup



■ To pair a mobile phone (when there is no phone paired to the system)

1. Select **Phone**.
2. Select **Yes**.
3. Make sure your phone is in search or discoverable mode, then select **Continue**.
 - ▶ HFT automatically searches for a *Bluetooth*® device.
4. Select your phone when it appears on the list.
 - ▶ If your phone does not appear, you can select **Refresh** to search again.
 - ▶ If your phone still does not appear, select **Phone Not Found** and search for *Bluetooth*® devices using your phone. From your phone, search for **Honda HFT**.
5. The system gives you a pairing code on the audio/information screen.
 - ▶ Confirm if the pairing code on the screen and your phone match. This may vary by phone.

☞ Phone Setup



Your *Bluetooth*-compatible phone must be paired to the system before you can make and receive hands-free calls.

Phone Pairing Tips:

- You cannot pair your phone while the vehicle is moving.
- Up to six phones can be paired.
- Your phone's battery may drain faster when it is paired to the system.
- If your phone is not ready for pairing or not found by the system within three minutes, the system will time out and return to idle.

Once you have paired a phone, you can see it displayed on the screen with one or two icons on the right side.





These icons indicate the following:

- : The phone can be used with HFT.
- : The phone is compatible with *Bluetooth*® Audio.

If there is an active connection to Apple CarPlay, pairing of additional *Bluetooth*-compatible devices is unavailable and **Add Bluetooth Device** is grayed out from the **Bluetooth Device List** screen.



■ To change the currently paired phone

1. Go to the **Phone Settings** screen.
 - ▶ **Phone Settings** screen P. 418
2. Select **Bluetooth Device List**.
3. Select a phone to connect.
 - ▶ HFT disconnects the connected phone and starts searching for another paired phone.
4. Select **Connect**  , **Connect** , or **Connect** .

■ To change the pairing code setting

1. Select .
2. Select **Settings**.
3. Select **Bluetooth / Wi-Fi**.
4. Select the **Bluetooth** tab.
5. Select **Edit Pairing Code**.
6. Select **Random** or **Fixed**.



☒ To change the currently paired phone

If no other phones are found or paired when trying to switch to another phone, HFT will inform you that the original phone is connected again.

To pair other phones, select **Add Bluetooth Device** from the **Bluetooth Device List** screen.

☒ To change the pairing code setting

The default pairing code is **0000** until you change the setting.

To create your own, select **Fixed**, and delete the current code, then enter a new one.

For a randomly generated pairing code each time you pair a phone, select **Random**.

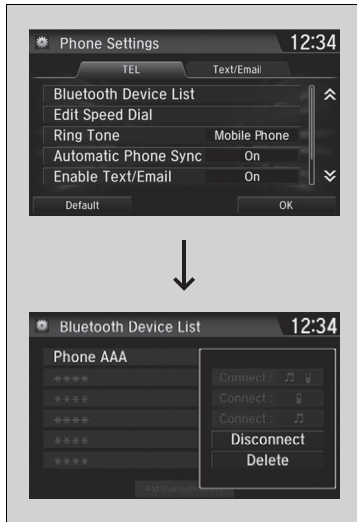

■ **To delete a paired phone**

1. Go to the **Phone Settings** screen.
 - ▶ **Phone Settings screen** P. 418
2. Select **Bluetooth Device List**.
3. Select a phone you want to delete.
4. Select **Delete**.
5. A confirmation message appears on the screen. Select **Yes**.

To Set Up Text Message/E-mail Options*

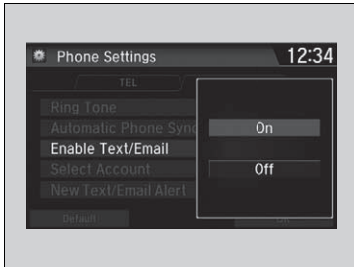

■ To turn on or off the text/e-mail function

1. Go to the **Phone Settings** screen.
 ▶ **Phone Settings screen** P. 418
2. Select the **Text/Email** tab, then **Enable Text/Email**.
 ▶ A pop-up menu appears on the screen.
3. Select **On** or **Off**.

■ To turn on or off the text/e-mail notice

1. Go to the **Phone Settings** screen.
 ▶ **Phone Settings screen** P. 418
2. Select the **Text/Email** tab, then **New Text/Email Alert**.
 ▶ A pop-up menu appears on the screen.
3. Select **On** or **Off**.

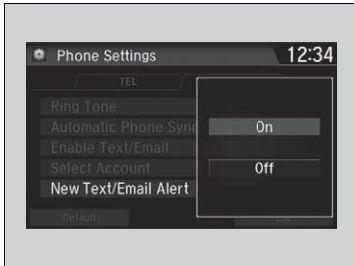

☒ To Set Up Text Message/E-mail Options*

To use the text message/e-mail function, it may be necessary to set up on your phone.

☒ To turn on or off the text/e-mail notice

On: A pop-up notification comes on every time you receive a new message.
Off: The message you receive is stored in the system without notification.

■ Ring Tone

You can change the ring tone setting.

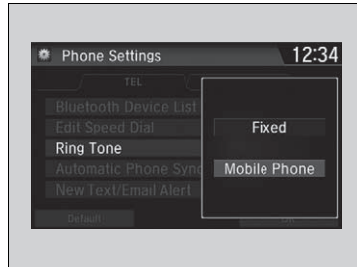

1. Go to the **Phone Settings** screen.
 - ▶ **Phone Settings screen** P. 418
2. Select **Ring Tone**.
3. Select **Fixed** or **Mobile Phone**.

▶▶ Ring Tone

Fixed: The fixed ring tone sounds from the speakers.
Mobile Phone: For certain connected phones, the ring tone stored in the phone sounds from the speakers.

Automatic Import of Cellular Phonebook and Call History

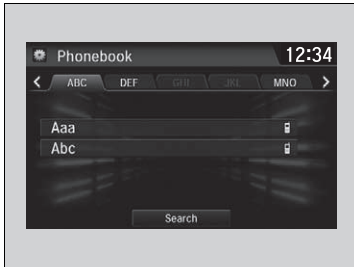

■ When Automatic Phone Sync is set to On:

When your phone is paired, the contents of its phonebook and call history are automatically imported to the system.

■ Changing the Automatic Phone Sync setting

1. Go to the **Phone Settings** screen.
 ▶ **Phone Settings** screen P. 418
2. Select **Automatic Phone Sync**.

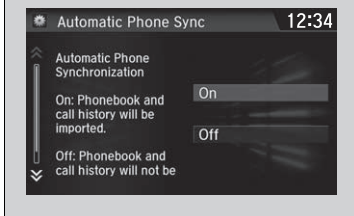
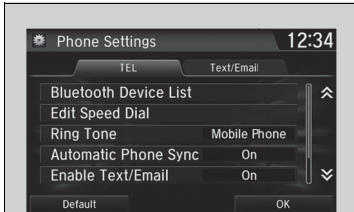

3. Select **On** or **Off**.

⌘ Automatic Import of Cellular Phonebook and Call History

When you select a name from the list in the cellular phonebook, you can see up to three category icons. The icons indicate what types of numbers are stored for that name.

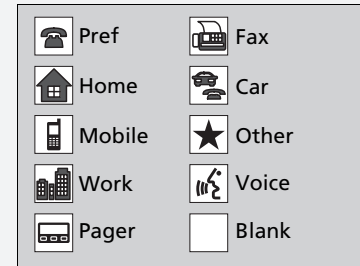

On some phones, it may not be possible to import the category icons to the system.

The phonebook is updated after every connection. Call history is updated after every connection or call.

■ Speed Dial

Up to 20 speed dial numbers can be stored per phone.

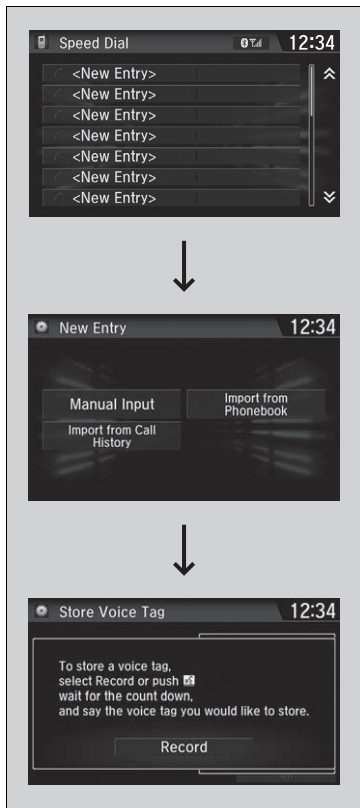

To store a speed dial number:

1. Go to the **Phone Menu** screen.
 - ▶ **Phone Menu screen** P. 420
2. Select **Speed Dial**.
3. Select **New Entry**.
 - From **Import from Call History**:
 - ▶ Select a number from the call history.
 - From **Manual Input**:
 - ▶ Input the number manually.
 - From **Import from Phonebook**:
 - ▶ Select a number from the connected mobile phone's imported phonebook.
4. When the speed dial is successfully stored, you are asked to create a voice tag for the number. Select **Yes** or **No**.
5. Select **Record**, or use the  button and follow the prompts to complete the voice tag.

▶▶ Speed Dial

When a voice tag is stored, press the  button to call the number using the voice tag. Say the voice tag name.

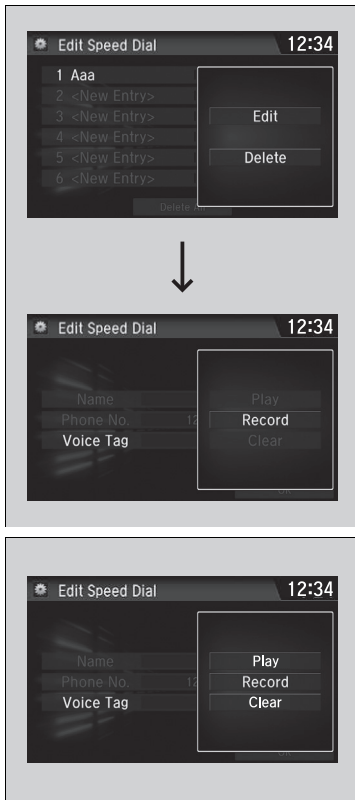

■ To add a voice tag to a stored speed dial number

1. Go to the **Phone Settings** screen.
▶ **Phone Settings screen** P. 418
2. Select **Edit Speed Dial**.
3. Select an existing speed dial entry.
▶ From the pop-up menu, select **Edit**.
4. Select **Voice Tag**.
▶ From the pop-up menu, select **Record**.
5. Select **Record**, or use the  button and follow the prompts to complete the voice tag.

■ To delete a voice tag

1. Go to the **Phone Settings** screen.
▶ **Phone Settings screen** P. 418
2. Select **Edit Speed Dial**.
3. Select an existing speed dial entry.
▶ From the pop-up menu, select **Edit**.
4. Select **Voice Tag**.
▶ From the pop-up menu, select **Clear**.
5. A confirmation message appears on the screen. Select **Yes**.

☒ Speed Dial

Avoid using duplicate voice tags.
Avoid using "home" as a voice tag.
It is easier for the system to recognize a longer name.
For example, use "John Smith" instead of "John."

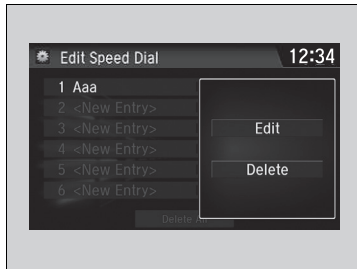

■ To edit a speed dial

1. Go to the **Phone Settings** screen.
 - ▶ **Phone Settings screen** P. 418
2. Select **Edit Speed Dial**.
3. Select an existing speed dial entry.
 - ▶ From the pop-up menu, select **Edit**.
4. Select a setting you want.

■ To delete a speed dial

1. Go to the **Phone Settings** screen.
 - ▶ **Phone Settings screen** P. 418
2. Select **Edit Speed Dial**.
3. Select an existing speed dial entry.
 - ▶ From the pop-up menu, select **Delete**.
4. A confirmation message appears on the screen. Select **Yes**.

Phonebook Phonetic Modification*

Add phonetic modifications or a new voice tag to the phone's contact name so that it is easier for HFT to recognize voice commands.

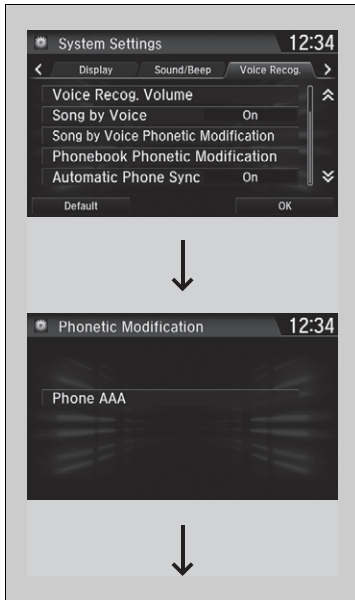

To add a new voice tag

1. Select .
2. Select **Settings**.
3. Select **System**.
4. Select the **Voice Recog.** tab.
5. Select **Phonebook Phonetic Modification**.
6. Select the phone you want to add phonetic modification to.

Phonebook Phonetic Modification*



You can store up to 20 phonetic modification items.

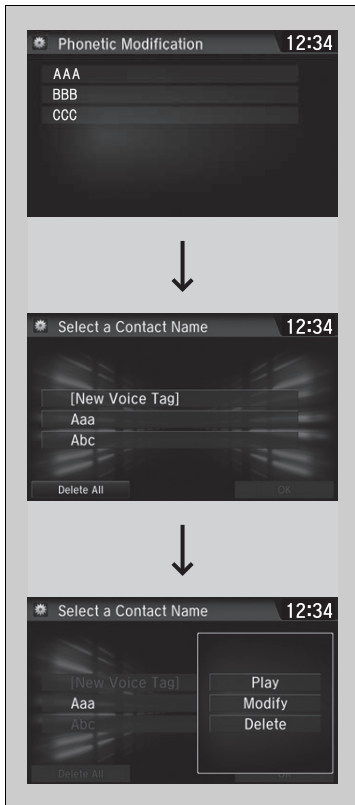

7. Select **New Voice Tag**.
8. Select a contact name you want to add to.
 - ▶ The pop-up menu appears on the screen.
9. Select **Modify**.
10. Using **Record** or the  button, follow the prompts to complete the voice tag.
11. You will receive a confirmation message on the screen, then select **OK**.



■ To modify a voice tag

1. Select .
2. Select **Settings**.
3. Select **System**.
4. Select the **Voice Recog.** tab.
5. Select **Phonebook Phonetic Modification**.
6. Select the phone you want to modify phonetic modification.
7. Select a contact name you want to modify.
 - ▶ The pop-up menu appears on the screen.
8. Select **Modify**.
9. Using **Record** or the  button, follow the prompts to complete the voice tag.
10. You will receive a confirmation message on the screen, then select **OK**.

☒ Phonebook Phonetic Modification*

You can only modify or delete contact names for the currently connected phone.



■ To delete a modified voice tag

1. Select .
2. Select **Settings**.
3. Select **System**.
4. Select the **Voice Recog.** tab.
5. Select **Phonebook Phonetic Modification**.
6. Select the phone you want to delete phonetic modification.
7. Select a contact name you want to delete.
 - ▶ The pop-up menu appears on the screen.
8. Select **Delete**.
 - ▶ The selected contact name has been selected.
9. Select **OK**.

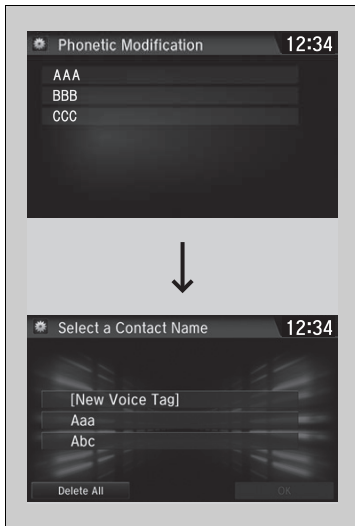

■ To delete all modified voice tags

1. Select .
2. Select **Settings**.
3. Select **System**.
4. Select the **Voice Recog.** tab.
5. Select **Phonebook Phonetic Modification**.
6. Select the phone you want to delete phonetic modification.
 - ▶ The contact name list appears.
7. Select **Delete All**.
8. You will receive a confirmation message on the screen, then select **Yes**.

■ Making a Call



You can make calls by inputting any phone number, or by using the imported phonebook, call history, speed dial entries, or redial.

▶▶ Making a Call

Any voice-tagged speed dial entry can be dialed by voice from most screens.

Press the  button and say the voice tag name.

Once a call is connected, you can hear the voice of the person you are calling through the audio speakers.

While there is an active connection with Apple CarPlay, phone calls can be made only from Apple CarPlay.

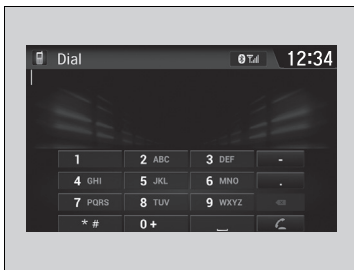
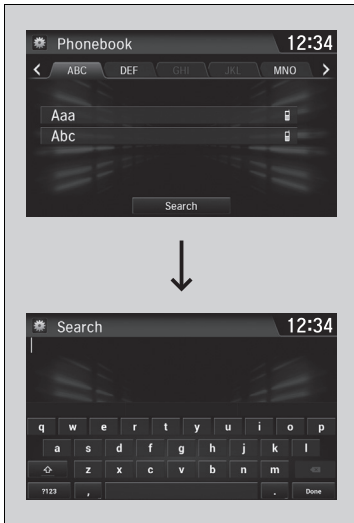

■ To make a call using the imported phonebook

1. Go to the **Phone Menu** screen.
 ▶ **Phone Menu screen** P. 420
2. Select **Phonebook**.
3. Select a name.
 - ▶ You can also search by letter. Select **Search**.
 - ▶ Use the keyboard on the touch screen for entering name, if multiple numbers exist select a number.
 - ▶ You can also swipe up or down on the / button on the steering wheel to scroll through the list of contacts alphabetically.
 ▶ **Audio Remote Controls** P. 257
4. Select a number.
 - ▶ Dialing starts automatically.

■ To make a call using a phone number

1. Go to the **Phone Menu** screen.
 ▶ **Phone Menu screen** P. 420
2. Select **Dial**.
3. Select a number.
 - ▶ Use the keyboard on the touch screen for entering numbers.
4. Select .
 - ▶ Dialing starts automatically.

☒ To make a call using the imported phonebook

You can call a stored voice-tagged speed dial number using voice commands.

▶ **Speed Dial** P. 428

☒ To make a call using a phone number

You can call a stored voice-tagged speed dial number using voice commands.

▶ **Speed Dial** P. 428

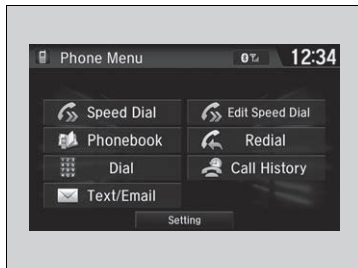

■ **To make a call using redial**

1. Go to the **Phone Menu** screen.
 - ▶ **Phone Menu screen** P. 420
2. Select **Redial**.
 - ▶ Dialing starts automatically.

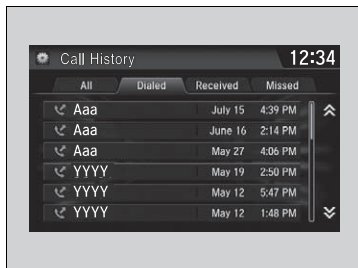

■ **To make a call using the Call History**

Call history is stored by **All**, **Dialed**, **Received**, and **Missed**.

1. Go to the **Phone Menu** screen.
 - ▶ **Phone Menu screen** P. 420
2. Select **Call History**.
3. Select **All**, **Dialed**, **Received**, or **Missed**.
4. Select a number.
 - ▶ Dialing starts automatically.



■ **To make a call using a Speed Dial entry**

1. Go to the **Phone Menu** screen.
 - ▶ **Phone Menu screen** P. 420
2. Select **Speed Dial**.
3. Select a number.
 - ▶ Dialing starts automatically.

☒ **To make a call using the Call History**

The call history displays the last 20 all, dialed, received, or missed calls. (Appears only when a phone is connected to the system.)

☒ **To make a call using a Speed Dial entry**

When a voice tag is stored, press the  button to call the number using the voice tag.

▶ **Speed Dial** P. 428



Any voice-tagged speed dial entry can be dialed by voice from any screen.

Press the  button and follow the prompts.

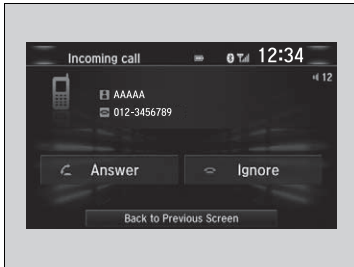
Receiving a Call



When there is an incoming call, an audible notification sounds (if activated) and the **Incoming call** screen appears.

Press the  button to answer the call.
Press the  button to decline or end the call.

Options During a Call

The following options are available during a call.

Mute: Mute your voice.

Transfer: Transfer a call from the system to your phone.

Touch Tones: Send numbers during a call. This is useful when you call a menu-driven phone system.

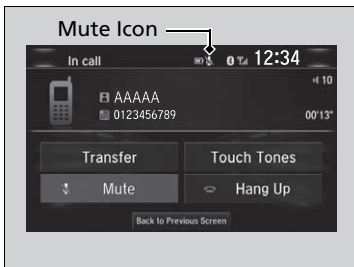

The available options are shown on the lower half of the screen.

Select the option.

- ▶ The mute icon appears when **Mute** is selected. Select **Mute** again to turn it off.

Receiving a Call



Call Waiting

Press the  button to put the current call on hold to answer the incoming call.

Press the  button again to return to the current call.

Select **Ignore** to ignore the incoming call if you do not want to answer it.

Press the  button if you want to hang up the current call.

You can select the icons on the audio/information screen instead of the  and  buttons.

Options During a Call

Touch Tones: Available on some phones.

You can select the icons on the audio/information screen.

■ Receiving a Text Message/E-mail*, *1

HFT can display newly received text or e-mail messages as well as 20 of the most recently received messages on a linked mobile phone. Each received message can be read aloud and replied to using a fixed common phrase.



1. A pop-up appears and notifies you of a new text message or e-mail.
2. Select **Read** to listen to the message.
 - ▶ The text message or e-mail is displayed. The system automatically starts reading out the message.
3. To discontinue the message read-out, select **Stop**.

▣ Receiving a Text Message/E-mail*, *1

The system does not display any received messages while you are driving. You can only hear them read aloud.

The system can only receive messages that are sent a text (SMS) messages. The message sent using the data services will not be displayed in the list.

With some phones, you may be able to display up to 20 most recent text messages and e-mails.

When you receive a text message or e-mail for the first time since the phone is paired to HFT, you are asked to turn the **New Text/Email Alert** setting to **On**.

➤ **To turn on or off the text/e-mail notice**
P. 425

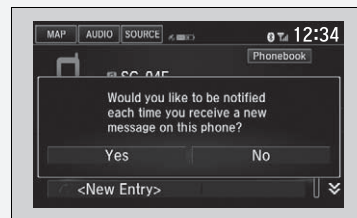

*1: Message will not be read out depending on the language.

Selecting a Mail Account*

If a paired phone has text message or mail accounts, you can select one of them to be active and receive notifications.

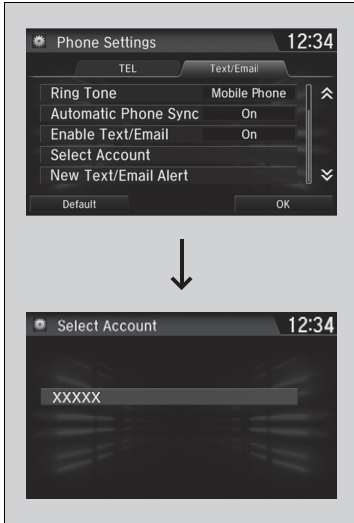

1. Go to the **Phone Settings** screen.
▶ **Phone Settings screen** P. 418
2. Select the **Text/Email** tab, then **Select Account**.
▶ A pop-up menu appears on the screen.
3. Select **Text Messages** or an e-mail account you want.

Selecting a Mail Account*

You can also select a mail account from the folder list screen or the message list screen.

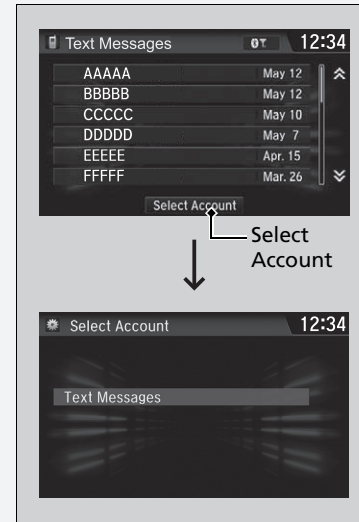

You can only receive notifications from one text message or mail account at a time.

■ Displaying Messages*, *1





■ Displaying text messages

1. Go to the **Phone Menu** screen.
 - ▶ **Phone Menu screen** P. 420
2. Select **Text/Email**.
 - ▶ Select account if necessary.
3. Select a message.
 - ▶ The text message is displayed. The system automatically starts reading the message aloud.

»» Displaying Messages*, *1

The  icon appears next to an unread message.

If you delete a message on the phone, the message is also deleted in the system. If you send a message from the system, the message goes to your phone's mailbox.

To see the previous or next message, select  (previous) or  (next) on the message screen.

*1: Message will not be read out depending on the language.

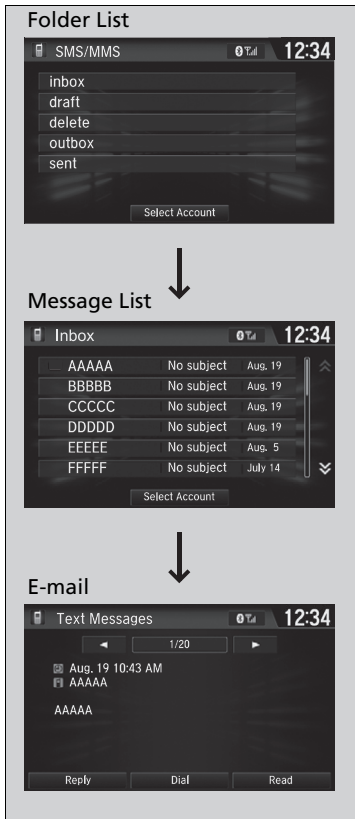

■ Displaying e-mails

1. Go to the **Phone Menu** screen.
 - ▶ **Phone Menu screen** P. 420
2. Select **Text/Email**.
 - ▶ Select **Select Account** if necessary.
3. Select a folder.
 - ▶ The e-mail is displayed. The system automatically starts reading the message aloud.
4. Select a message.
 - ▶ The e-mail is displayed. The system automatically starts reading the message aloud.

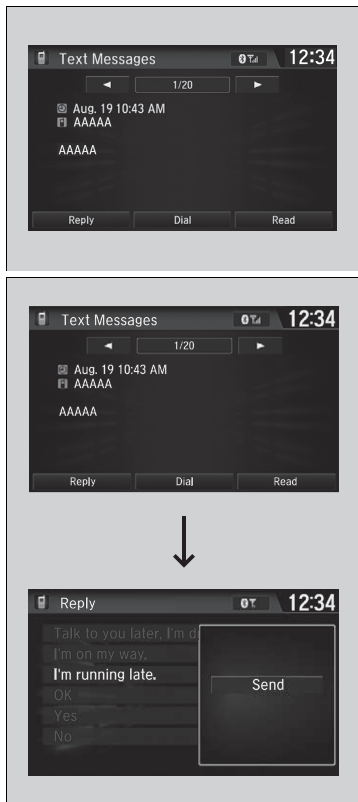

■ Read or Stop reading a message

1. Go to the text or e-mail message screen.
 - ▶ The system automatically starts reading the message aloud.
 - ☑ **Displaying Messages***, *1 P. 442
2. Select **Stop** to stop reading.
 - Select **Read** again to start reading the message from the beginning.

■ Reply to a message

1. Go to the text or e-mail message screen.
 - ▶ The system automatically starts reading the message aloud.
 - ☑ **Displaying Messages***, *1 P. 442
2. Select **Reply**.
3. Select the reply message.
 - ▶ The pop-up menu appears on the screen.
4. Select **Send** to send the message.
 - ▶ **Complete** appears on the screen when the reply message was successfully sent.

☞ Reply to a message

The available fixed reply messages are as follows:

- **Talk to you later, I'm driving.**
- **I'm on my way.**
- **I'm running late.**
- **OK**
- **Yes**
- **No**

You cannot add, edit, or delete reply messages.

Only certain phones receive and send messages when paired and connected. For a list of compatible phones, ask a dealer.

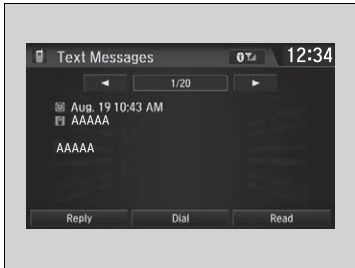

■ Making a call to a sender

1. Go to the text message screen.
2. Select **Dial**.

Driving



This chapter discusses driving, refueling, and information on items such as accessories.

Before Driving

Driving Preparation	448
Load Limit	451

Towing a Trailer*

Towing Preparation	452
Driving Safely with a Trailer	456

When Driving

Starting the Engine	461
Precautions While Driving	466
Continuously Variable Transmission*	467
Shifting	468
Auto Idle Stop*	478
ECON Button	483
Cruise Control*	484

Adjustable Speed Limiter*	490
Intelligent Speed Limiter	494
Front Sensor Camera*	501
Adaptive Cruise Control (ACC) with Low Speed Follow (LSF)*	503
Adaptive Cruise Control (ACC)*	518
Road Departure Mitigation System*	532
Traffic Sign Recognition System*	536
Lane Keeping Assist System (LKAS)*	543
Vehicle Stability Assist (VSA) System	550
Agile Handling Assist	552
Blind spot information (BSI) System*	553
Deflation Warning System	556
Adjusting Headlight Distribution	559

Braking

Brake System	560
Anti-lock Brake System (ABS)	566
Brake Assist System	567
Emergency Stop Signal	568

Parking Your Vehicle

Collision Mitigation Braking System (CMBS)*	569
Parking Sensor System*	583
Cross Traffic Monitor*	585

Multi-View Rear Camera*

.....	589
Refueling	591
Fuel Economy and CO₂ Emissions	594
Turbo Engine Vehicle*	595

* Not available on all models

Driving Preparation

Check the following items before you start driving.

Exterior Checks

- Make sure there are no obstructions on the windows, door mirrors, exterior lights, or other parts of the vehicle.
 - ▶ Remove any frost, snow, or ice.
 - ▶ Remove any snow on the roof, as this can slip down and obstruct your field of vision while driving. If frozen solid, remove ice once it has softened.
 - ▶ When removing ice from around the wheels, be sure not to damage the wheel or wheel components.
- Make sure the bonnet is securely closed.
 - ▶ If the bonnet opens while driving, your front view will be blocked.
- Make sure the tyres are in good condition.
 - ▶ Check air pressures, and check for damage and excessive wear.
 - ✎ **Checking and Maintaining Tyres** P. 649
- Make sure there are no people or objects behind or around the vehicle.
 - ▶ There are blind spots from the inside.

Exterior Checks

NOTICE

When doors are frozen shut, use warm water around the door edges to melt any ice. Do not try to force them open, as this can damage the rubber trim around the doors. When done, wipe dry to avoid further freezing.

Do not pour warm water into the key cylinder. You will be unable to insert the key if the water freezes in the hole.

Heat from the engine and exhaust can ignite flammable materials left under the bonnet, causing a fire. If you've parked your vehicle for an extended period, inspect and remove any debris that may have collected, such as dried grass and leaves that have fallen or have been carried in for use as a nest by a small animal. Also check under the bonnet for leftover flammable materials after you or someone else has performed maintenance on your vehicle.

Interior Checks

- Store or secure all items on board properly.
 - ▶ Carrying too much luggage, or improperly storing it, can affect your vehicle's handling, stability, stopping distance, and tyres, and make it unsafe.
 - **Load Limit** P. 451
- Do not pile items higher than the seat height.
 - ▶ They can block your view and may be thrown forward in the event of sudden braking.
- Do not place anything in the front seat footwells. Make sure to secure the floor mat*.
 - ▶ An object or unsecured floor mat can interfere with your brake and accelerator pedal operation while driving.
- If you have any animals on board, do not let them move around in the vehicle.
 - ▶ They may interfere with driving and a crash could occur.
- Securely close all doors and the boot.
- Adjust your seating position properly.
 - ▶ Adjust the head restraint, too.
 - **Adjusting the Seats** P. 222
 - **Adjusting the Front Head Restraints** P. 226
- Adjust the mirrors and steering wheel properly for your driving.
 - ▶ Adjust them while sitting in the proper driving position.
 - **Adjusting the Mirrors** P. 220
 - **Adjusting the Steering Wheel** P. 219

* Not available on all models

Interior Checks

The headlight aim is set by the factory, and does not need to be adjusted. However, if you regularly carry heavy items in the boot or tow a trailer, have the aiming readjusted at a dealer or by a qualified technician.

Models with headlight adjuster

You can adjust the low beam headlight angle by yourself.

➤ **Headlight Adjuster*** P. 211

Models with automatic headlight adjusting system

Your vehicle is equipped with the automatic headlight adjusting system that automatically adjusts the vertical angle of the low beam headlights.

Continued

- Be sure items placed on the floor behind the front seats cannot roll under the seats.
 - ▶ They can interfere with the driver's ability to operate the pedals, or the operation of the seats.
- Everyone in the vehicle must fasten their seat belt.
 - 📖 **Fastening a Seat Belt** P. 46
- Make sure that the indicators in the instrument panel come on when you start the vehicle, and go off soon after.
 - ▶ Always have a dealer check the vehicle if a problem is indicated.
 - 📖 **Indicators** P. 94

Load Limit

When you load luggage, the total weight of the vehicle, all passengers, and luggage must not exceed the maximum permissible weight.

➤ **Specifications** P. 724

The load for the front and rear axles also must not exceed the maximum permissible axle weight.

➤ **Specifications** P. 724

⚠ Load Limit

⚠ WARNING

Overloading or improper loading can affect handling and stability and cause a crash in which you can be hurt or killed.

Follow all load limits and other loading guidelines in this manual.

Middle Eastern except Israeli and Turkish models

Your vehicle is not designed to tow a trailer. Attempting to do so can void your warranties.

Israeli, Turkish, and except Middle Eastern models

Towing Preparation

Towing Load Limits

Your vehicle can tow a trailer if you carefully observe the load limits, use the proper equipment, and follow the towing guidelines. Check the load limits before driving.

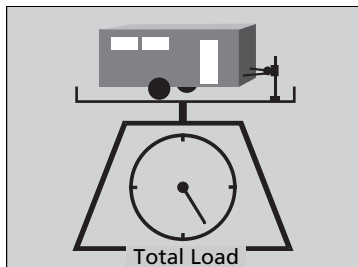

■ Total trailer weight

Do not exceed the maximum towing weight of the trailer and towbar (with/without brakes), luggage and everything in or on it.

Towing loads in excess of the maximum towing weight can seriously affect vehicle handling and performance and can damage the engine and drivetrain.

» Towing Load Limits

⚠ WARNING

Exceeding any load limit or improperly loading your vehicle and trailer can cause a crash in which you can be seriously hurt or killed.

Check the loading of your vehicle and trailer carefully before starting to drive.

Check if all loads are within limits at a public scale. If a public scale is not available, add the estimated weight of your luggage load to the weight of your trailer (as quoted by the manufacturer), and then measure the tongue load with an appropriate scale or tongue gauge or estimate it based on luggage distribution.

Refer to the trailer owner's manual for additional information.

Break-in Period

Avoid towing a trailer during your vehicle's first 1,000 km.

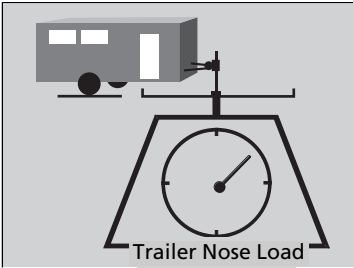

■ Towbar down load

The trailer nose load should never exceed 75 kg. This is the amount of weight the trailer puts on the towbar when it is fully-loaded. As a rule of thumb for trailer weights of less than 500 kg, the trailer nose load should be 10 percent of the total trailer package.

- Excessive trailer nose load reduces front tyre traction and steering control. Too little trailer nose load can make the trailer unstable and cause it to sway.
- To achieve a proper trailer nose load, start by loading 60 % of the load towards the front of the trailer and 40 % towards the rear. Readjust the load as needed.

☒ Towing Load Limits

If you tow a trailer in mountainous conditions, remember to reduce 10 % of the combined vehicle weights from the maximum towing weight for every 1,000 metres of elevation.

Never exceed the maximum towing weight and specified load limit.

☒ **Specifications** P. 724

■ Towing Equipment and Accessories

Towing equipment varies by the size of your trailer, how much load you are towing, and where you are towing.

■ Towbars

The towbar must be of an approved type and properly bolted to the underbody.

■ Safety chains

Always use safety chains when you tow a trailer. Leave enough slack to allow the trailer to turn corners easily, but do not allow the chains to drag on the ground.

■ Trailer brakes

If you are thinking of getting a trailer that has brakes, be sure they are electronically actuated. Do not attempt to tap into your vehicle's hydraulic system. No matter how successful it may seem, any attempt to attach trailer brakes to your vehicle's hydraulic system will lower braking effectiveness and create a potential hazard.

■ Additional towing equipment

There may be laws requiring special outside mirrors when towing a trailer. Even if mirrors are not required in your locale, you should install special mirrors if visibility is restricted in any way.

■ Trailer light

Trailer lights and equipment must comply with the regulations of the country where you are driving. Check with your local trailer sales or rental agency for the requirements in the area where you plan to tow.

► Towing Equipment and Accessories

Make sure that all equipment is properly installed and maintained, and that it meets the regulations of the country where you are driving.

Consult your trailer sales or rental agency if any other items are recommended or required for your towing situation.

Consult your trailer maker for proper installation and setup of the equipment. Improper installation and setup can affect the handling, stability, and braking performance of your vehicle.

The lighting and wiring of trailers can vary by type and brand. If a connector is required, it should only be installed by a qualified technician.

1.5 L engine models

■ **Continuously variable transmission fluid cooler**

Install an additional CVTF (continuously variable transmission fluid) cooler to help prevent the transmission from overheating, and damaging.

An additional CVTF cooler is required to keep the transmission from overheating when towing more than 500 kg.

Driving Safely with a Trailer

■ Things You Need To Know Before Towing a Trailer

- Have the trailer properly serviced and keep it in good condition.
- Make sure that all the weights and load in the vehicle and trailer are within limits.
 - ✎ **Towing Load Limits** P. 452
- Securely attach the tow bar, safety chains, and other necessary parts to the trailer.
- Securely store all the items in and on the trailer so that they do not shift while driving.
- Check if the lights and brakes on the trailer are working properly.
- Check the pressures of the trailer tyres, including the spare.
- Check regulations concerning the maximum speed or driving restrictions for vehicles towing trailers. If you are driving across several countries, check each country's requirements before leaving home, because regulations may vary.

▣ Driving Safely with a Trailer

Operating speed when towing a trailer is restricted up to 100 km/h.

Parking

In addition to the normal precautions, place wheel chocks at each of the trailer's tyres.

We recommend you drive uphill or less than 12% slope. Follow the trailer association's recommendations for suitable roads.

Winds caused by passing large vehicles can sway your trailer, keep a constant speed and steer straight ahead.

Always drive slowly and have someone guide you when reversing.

Towing Speeds and Gears

- Drive slower than normal.
- Obey posted speed limits for vehicles with trailers.
- Use the **[D]** position when towing a trailer on level roads.

Turning and Braking

- Turn more slowly and with a wider turning arc than normal.
- Allow more time and distance for braking.
- Do not brake or turn suddenly.

Driving in Hilly Terrain

- Monitor your temperature gauge. If it nears the white (Hot) mark, turn off the climate control system and reduce speed. Pull to the side of the road safely to cool down the engine if necessary.

Continuously variable transmission models

- Shift to the **[S]** position and use the paddle shifter* to shift down when driving down hills.
This helps to increase engine braking efficiently and prevent the brake system from overheating.

⌘ Towing Speeds and Gears

When towing a fixed-sided trailer (e.g., camper), do not exceed 88 km/h. At higher speeds, the trailer may sway or affect vehicle handling.

The shift down indicator* will not prompt to downshift to 1st gear. It is up to you to downshift to 1st gear to increase engine braking. Avoid sudden engine braking.

Road and traffic conditions may require you to shift at times other than those indicated.

⌘ Driving in Hilly Terrain

Continuously variable transmission models with 5 positions

If you use the paddle shifters when driving uphill and downhill, select 3rd, 2nd, or 1st gear, depending on the vehicle speed and road conditions. Do not use 4th and 5th gears.

* Not available on all models

Models without keyless access system

Starting the Engine



1. Make sure the electric parking brake is applied.
 - ▶ The parking brake and brake system indicator comes on for 15 seconds when you pull up the electric parking brake switch.

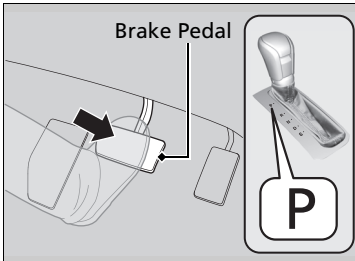

Continuously variable transmission models

2. Check that the shift lever is in **P**, then depress the brake pedal.
 - ▶ Although it is possible to start the vehicle in **N**, it is safer to start it in **P**.

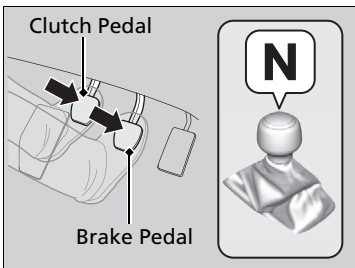

Manual transmission models

2. Check that the shift lever is in **N**. Then depress the brake pedal with your right foot, and the clutch pedal with your left foot.
 - ▶ The clutch pedal must be fully depressed to start the engine.

Starting the Engine

Keep your foot firmly on the brake pedal when starting the engine.

The engine is harder to start in cold weather and in thinner air found at altitudes above 2,400 metres.

When starting the engine in cold weather, turn off all electrical accessories such as the lights, climate control system, and rear demister in order to reduce battery drain.

If the exhaust system sounds abnormal or you can smell exhaust gas inside the vehicle, have your vehicle checked by a dealer. There may be a problem with the engine or exhaust system.

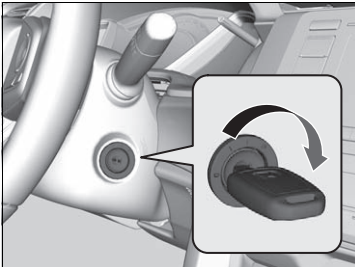
**All models**

3. Turn the ignition switch to START  without depressing the accelerator pedal.

Starting the Engine

Do not hold the key in START  for more than 10 seconds.

- If the engine does not start right away, wait for at least 30 seconds before trying again.
- If the engine starts, but then immediately stops, wait at least 30 seconds before repeating step 3 while gently depressing the accelerator pedal. Release the accelerator pedal once the engine starts.

Models with Auto Idle Stop

Do not wait until the engine starts with the key in START .

The immobilizer system protects your vehicle from theft. If an improperly coded device is used, the engine's fuel system is disabled.

 **Immobilizer System** P. 189

Starting to Drive

Continuously variable transmission models

1. Keeping your right foot on the brake pedal, put the shift lever in **D**. Select **R** when reversing.
2. With the electric parking brake applied, release the brake pedal and gently depress the accelerator pedal.
 - ▶ Make sure the parking brake and brake system indicator goes off.
 - 🔗 **Parking Brake** P. 560

Hill start assist system

Hill start assist keeps the brake engaged briefly to help prevent the vehicle from rolling on inclines as you move your foot from the brake pedal to the accelerator.

Manual transmission models

Depress the clutch pedal, and shift to **1** when facing uphill, or **R** when facing downhill, then release the brake pedal.

Continuously variable transmission models

Move the shift lever to **D** or **S** or **L*** when facing uphill, or **R** when facing downhill, then release the brake pedal.

Starting the Engine

You can also release the electric parking brake by pressing the electric parking brake switch while depressing the brake pedal. When facing downhill, you can start your vehicle more smoothly by manually releasing it with the electric parking brake switch than by releasing it with the accelerator pedal.

1.5 L engine models with manual transmission

If the engine stalls, fully depress the clutch pedal within three seconds. The engine may automatically restart under certain conditions. Otherwise, follow the standard procedure.

Hill start assist system

Hill start assist may not prevent the vehicle from rolling downhill on a very steep or slippery slope, and does not operate on small inclines.

Hill start assist is not a replacement for the electric parking brake.

Hill start assist will operate even when VSA is switched off.

Models with keyless access system

Starting the Engine

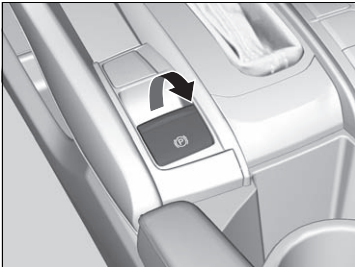

1. Make sure the electric parking brake is applied.
 - ▶ The parking brake and brake system indicator comes on for 15 seconds when you pull up the electric parking brake switch.

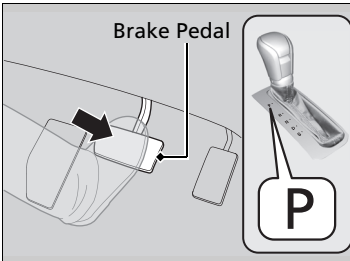

Continuously variable transmission models

2. Check that the shift lever is in **P**, then depress the brake pedal.
 - ▶ Although it is possible to start the vehicle in **N**, it is safer to start it in **P**.

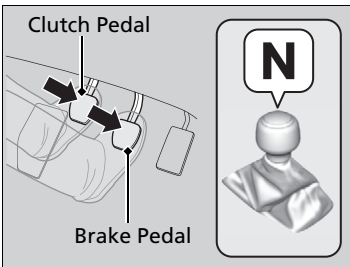

Manual transmission models

2. Check that the shift lever is in **N**. Then depress the brake pedal with your right foot, and the clutch pedal with your left foot.
 - ▶ The clutch pedal must be fully depressed to start the engine.

Starting the Engine

Keep your foot firmly on the brake pedal when starting the engine.

The engine is harder to start in cold weather and in thinner air found at altitudes above 2,400 metres.

When starting the engine in cold weather, turn off all electrical accessories such as the lights, climate control system, and rear demister in order to reduce battery drain.

If the exhaust system sounds abnormal or you can smell exhaust gas inside the vehicle, have your vehicle checked by a dealer. There may be a problem with the engine or exhaust system.

Bring the keyless remote close to the **ENGINE START/STOP** button if the battery in the keyless remote is weak.

▶ **If the Keyless Remote Battery is Weak**
P. 693

The engine may not start if the keyless remote is subjected to strong radio waves.

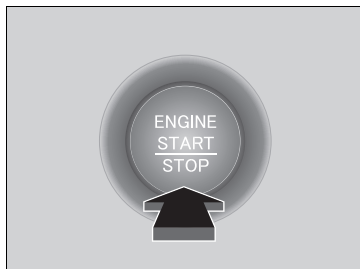

All models

3. Press the **ENGINE START/STOP** button without depressing the accelerator pedal.

▶▶ Starting the Engine

Do not hold the **ENGINE START/STOP** button to start the engine.
If the engine does not start, wait at least 30 seconds before trying again.

The immobilizer system protects your vehicle from theft. If an improperly coded key (or other device) is used, the engine's fuel system is disabled.

▶ **Immobilizer System** P. 189

Stopping the Engine

You can turn the engine off when the vehicle is completely stopped.

Continuously variable transmission models

1. Shift to **P**.
2. Press the **ENGINE START/STOP** button.

Manual transmission models

- If the shift lever is in **N**, press the **ENGINE START/STOP** button.
- If the shift lever is in any gear other than **N**, depress the clutch pedal, then press the **ENGINE START/STOP** button.



Remote Engine Start with Vehicle Feedback*

You can remotely start the engine using the  button on the keyless remote.

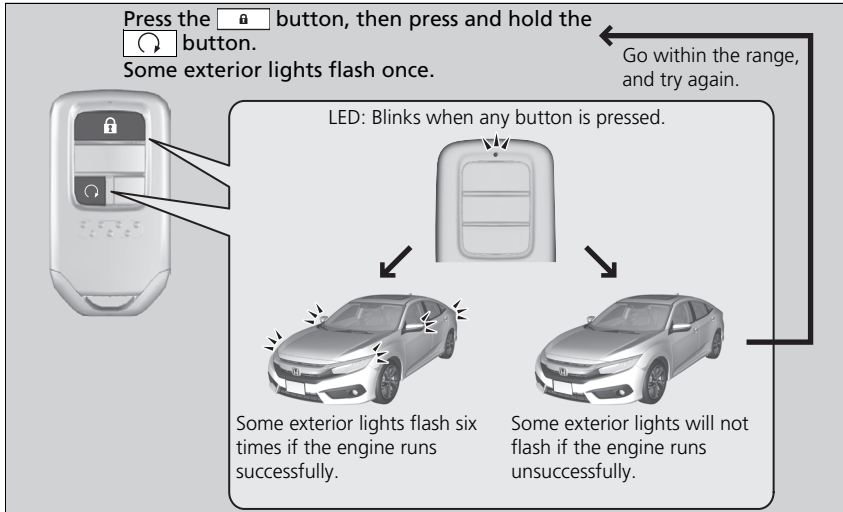
To start the engine



When started remotely, the engine automatically shuts off after 10 minutes of idling and the brake pedal and **ENGINE START/STOP** button have not been pressed simultaneously.

To extend the run time for another 10 minutes during the first run, press the  button, then press and hold the  button.

- ▶ Some exterior lights flash six times if a 10-minute extension request was transmitted successfully.

* Not available on all models

Continued

Remote Engine Start with Vehicle Feedback*

⚠ WARNING

Engine exhaust contains toxic carbon monoxide.

Breathing carbon monoxide can kill you or cause unconsciousness.

Never use the remote engine starter when the vehicle is parked in a garage or other area with limited ventilation.

The remote engine start may violate local laws. Before using the remote engine start, check your local laws.

If there are buildings and obstacles between your vehicle and the remote, the range will be reduced. The range may be less the vehicle is running. This distance may vary by external electrical interference.

The engine may not start by the remote engine start if:

- You have disabled a remote engine start setting using the audio/information screen*.
- The power mode is not in VEHICLE OFF (LOCK).
- The gear is in a position other than .
- The bonnet is open, or any door or the boot is unlocked.

■ To stop the engine

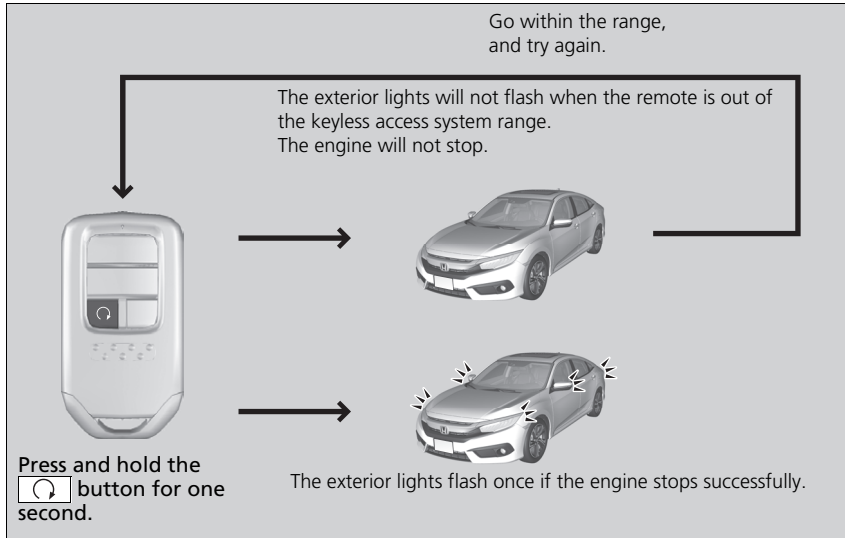

▶▶ Remote Engine Start with Vehicle Feedback *

- You have already used the remote twice to start the engine.
- Another registered keyless remote is in the vehicle.
- There is an antenna failure.
- Door is unlocked with the built-in key.
- The engine oil pressure is low.
- The engine coolant temperature is extremely high.
- The security system alarm is not set.

While the engine is running, the vehicle will automatically activate climate control with a preset temperature of 22°C.

When it is warm outside:

- The air conditioning is activated in recirculation mode.

When it is cold outside:

- The defroster is activated at a moderately warm temperature.
- The rear demister and door mirror heaters* are activated.

Starting to Drive

Continuously variable transmission models

When the engine was started using the  button* on the keyless remote

1. Depress the brake pedal and press the **ENGINE START/STOP** button simultaneously.

When the engine was started in any case

2. Put the shift lever in **D**. Select **R** when reversing.
3. With the electric parking brake is applied, release the brake pedal and gently depress the accelerator pedal.
 - ▶ Make sure the parking brake and brake system indicator goes off.
4. Gradually release the brake pedal and gently depress the accelerator pedal to pull away.

Hill start assist system

Hill start assist keeps the brake engaged briefly to help prevent the vehicle from rolling on inclines as you move your foot from the brake pedal to the accelerator.

Manual transmission models

Depress the clutch pedal, and shift to **1** when facing uphill, or **R** when facing downhill, then release the brake pedal.

Continuously variable transmission models

Move the shift lever to **D** or **S** or **L*** when facing uphill, or **R** when facing downhill, then release the brake pedal.

* Not available on all models

Starting to Drive

When the engine was started using the  button on the keyless remote*

The engine stops when the shift lever is moved out of **P** before the **ENGINE START/STOP** button is pressed. Follow the step 1 when starting to drive.

Starting the Engine

You can also release the electric parking brake by pressing the electric parking brake switch while depressing the brake pedal. When facing downhill, you can start your vehicle more smoothly by manually releasing it with the electric parking brake switch than by releasing it with the accelerator pedal.

1.5 L engine models with manual transmission

If the engine stalls, fully depress the clutch pedal within three seconds. The engine may automatically restart under certain conditions. Otherwise, follow the standard procedure.

Hill start assist system

Hill start assist may not prevent the vehicle from rolling downhill on a very steep or slippery slope, and does not operate on small inclines.

Hill start assist is not a replacement for the electric parking brake.

Hill start assist will operate even when VSA is switched off.

Precautions While Driving

■ In a Fog

Visibility becomes low when it is foggy. When you drive, turn on the low beam headlights even during the daytime. Slow down, using the road line in the centre, guard rails, and the taillights of the vehicle ahead of you as your driving guide.

■ In a Strong Wind

If a strong side wind drifts your vehicle while driving, hold the steering wheel tight. Slowly decelerate your vehicle and keep your vehicle in the middle of the road. Be careful with wind gusts especially when your vehicle is exiting a tunnel, driving on a bridge or river bank, and driving through an open area like a quarry, and when a large truck is passing by.

■ In Rain

The road is slippery when raining. Avoid hard braking, rapid acceleration, and abrupt steering and be more cautious when driving. It is likely to experience hydroplaning phenomenon if you are driving on a rutted road with puddles. Do not drive in deep water and on flooded roads. This can damage the engine or driveline, or cause electrical component failure.

» Precautions While Driving

CAUTION: Do not drive on the road where water is deep. Driving through deep water will cause damage to the engine and electrical equipment and the vehicle will break down.

Continuously variable transmission models

NOTICE

Do not operate the shift lever while pressing the accelerator pedal. You could damage the transmission.

NOTICE

If you repeatedly turn the steering wheel at an extremely low speed, or hold the steering wheel in the full left or right position for a while, the electric power steering (EPS) system heats up. The system goes into a protective mode, and limits its performance. The steering wheel becomes harder and harder to operate. Once the system cools down, the EPS system is restored. Repeated operation under these conditions can eventually damage the system.

Other Precautions

If there is a strong impact with something under the vehicle, stop in a safe location. Check the underside of the vehicle for damage or any fluid leaks.

Continuously Variable Transmission *

Creeping

The engine runs at a higher idle speed and creeping increases. Keep the brake pedal firmly depressed when stopped.

Kickdown

Quickly depressing the accelerator pedal while driving uphill may cause the transmission to drop to a lower gear, unexpectedly increasing vehicle speed. Depress the accelerator pedal carefully, especially on slippery roads and curves.

Precautions While Driving

If the ignition switch is turned to ACCESSORY **I***¹ while driving, the engine will shut down and all steering and brake power assist functions will stop, making it difficult to control the vehicle.

Do not put the shift lever in **N**, as you will lose engine braking (and acceleration) performance.

*1: Models with the keyless access system have an **ENGINE START/STOP** button instead of an ignition switch.

During the first 1,000 km of operation, avoid sudden acceleration or full throttle operation so as not to damage the engine or powertrain.

Avoid hard braking for the first 300 km. You should also follow this when the brake pads are replaced.

In Rain

Be careful when hydroplaning phenomenon occurs. When you drive on a road covered with water at excessive speed, a layer of water builds between the tyres and the road surface. If this occurs, the vehicle cannot respond to control inputs such as steering, and braking.

Slowly decelerate when you shift down. If the road is slippery, sudden engine braking can cause the tyres to skid.

* Not available on all models

Continuously variable transmission models with 6 positions

Shifting

Change the shift position in accordance with your driving needs.

■ Shift lever positions

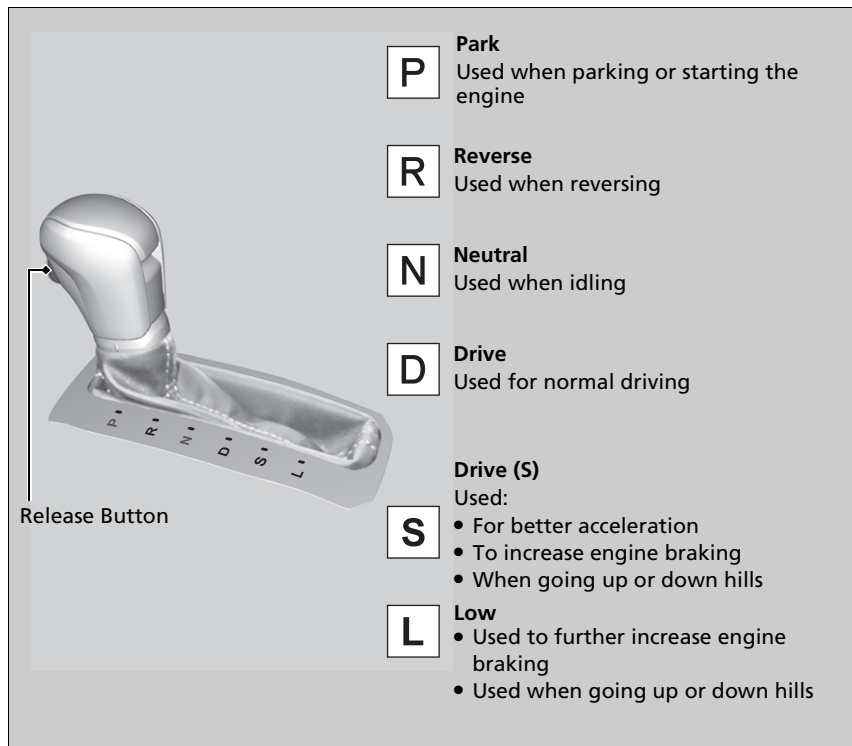

▶▶ Shifting

You cannot turn the ignition switch to LOCK **[O]***¹ and remove the key unless the shift lever is in **[P]**.

The vehicle may move forward very slightly even in **[N]** while the engine is cold. Depress the brake pedal firmly and, when necessary, apply the electric parking brake.

When shifting positions in extremely low temperatures (-30°C), there may be a short delay before the shift position is displayed. Always confirm you are in the correct shift position before driving.

*1: Models with the keyless access system have an **ENGINE START/STOP** button instead of an ignition switch.

Shift Lever Operation

Models with information display

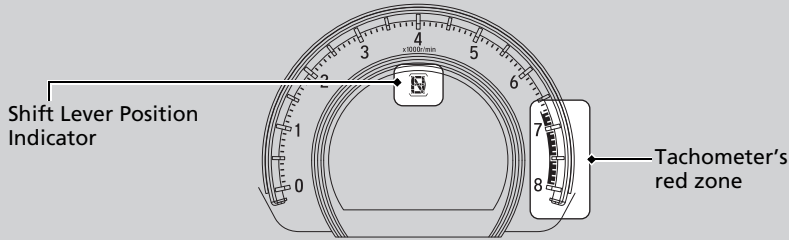

Models with driver information interface

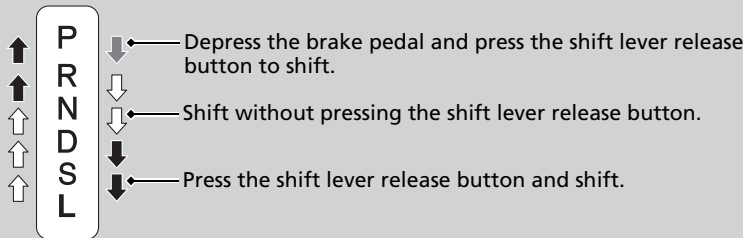
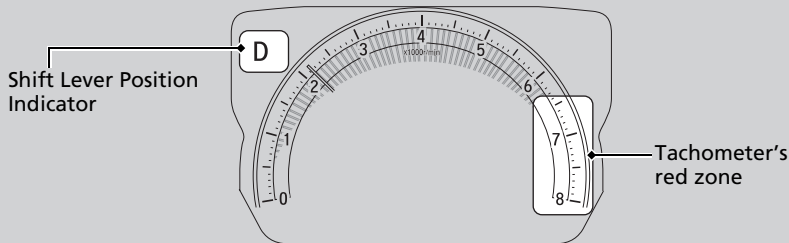

Shift Lever Operation

NOTICE

When you change the shift lever from **D** to **R** and vice versa, come to a complete stop and keep the brake pedal depressed.

Operating the shift lever before the vehicle has come to a complete standstill can damage the transmission.

Use the shift lever position indicator to check the lever position before pulling away.

Whichever position the shift lever is in when driving, blinking all shift lever position indicators indicate a transmission problem.

Avoid sudden acceleration and have the transmission checked by a dealer as soon as possible.

The fuel supply may be cut off if you drive at engine speeds in or over the tachometer's red zone (engine speed limit). If this happens, you may experience a slight jolt.

It may not be possible to operate the shift lever if the brake pedal is applied while the shift lever release button is held down.

Depress the brake pedal first.

Continuously variable transmission models with 5 positions

Shifting

Change the shift position in accordance with your driving needs.

■ Shift lever positions

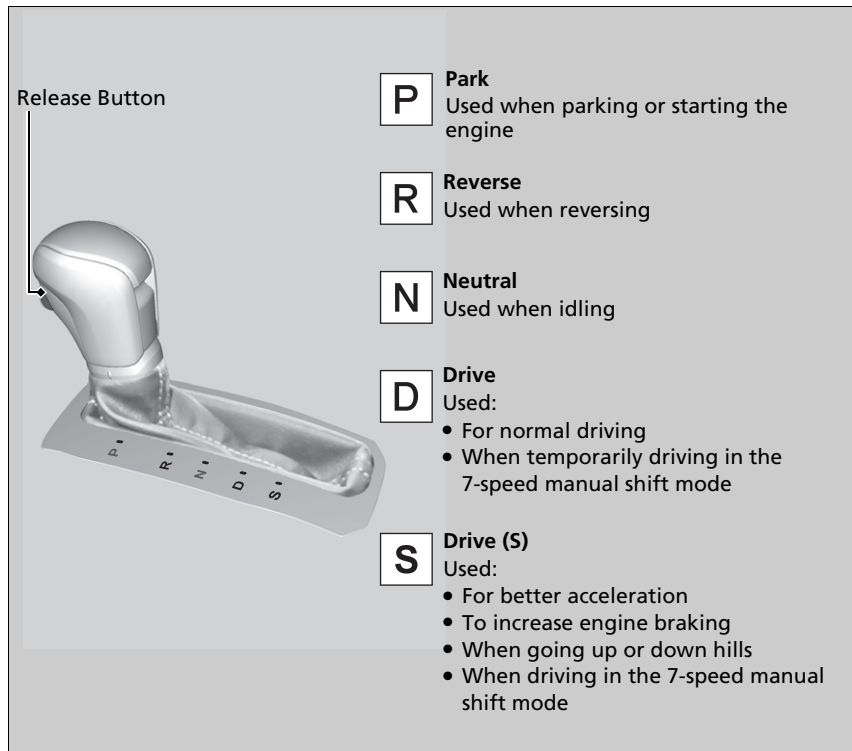

▶▶ Shifting

You cannot turn the ignition switch to LOCK **[0]***1 and remove the key unless the shift lever is in **[P]**.

The vehicle may move forward very slightly even in **[N]** while the engine is cold.

Depress the brake pedal firmly and, when necessary, apply the electric parking brake.

When shifting positions in extremely low temperatures (-30°C), there may be a short delay before the shift position is displayed. Always confirm you are in the correct shift position before driving.

*1: Models with the keyless access system have an **ENGINE START/STOP** button instead of an ignition switch.

Shift Lever Operation

Models with information display

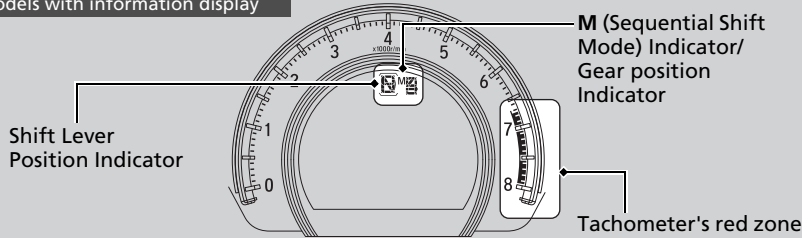

Models with driver information interface

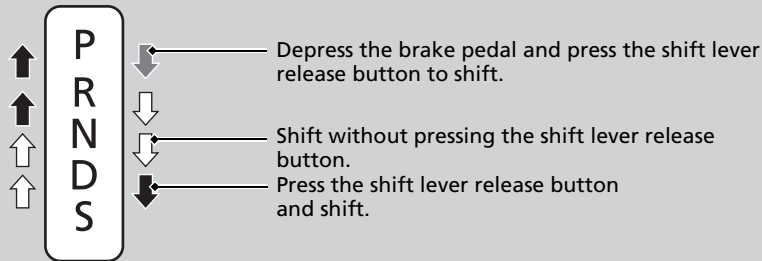
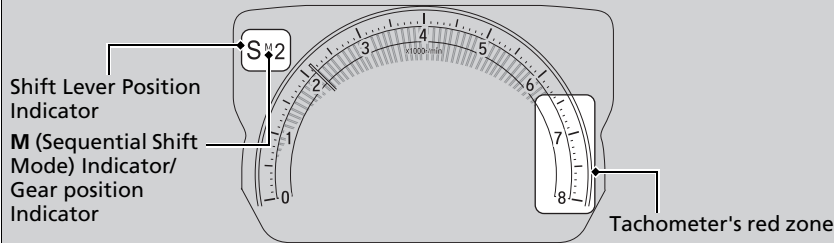

Shift Lever Operation

NOTICE

When you change the shift lever from **D** to **R** and vice versa, come to a complete stop and keep the brake pedal depressed. Operating the shift lever before the vehicle has come to a complete standstill can damage the transmission.

Use the shift lever position indicator to check the lever position before pulling away.

Whichever position the shift lever is in when driving, blinking all shift lever position indicators indicate a transmission problem. Avoid sudden acceleration and have the transmission checked by a dealer as soon as possible.

The fuel supply may be cut off if you drive at engine speeds in or over the tachometer's red zone (engine speed limit). If this happens, you may experience a slight jolt.

It may not be possible to operate the shift lever if the brake pedal is applied while the shift lever release button is held down. Depress the brake pedal first.

■ 7-Speed Manual Shift Mode

Use the paddle shifters to change between 1st and 7th speeds without removing your hands from the steering wheel. The transmission switches to the 7-speed manual shift mode when you pull a paddle shifter while driving. This mode is useful when engine braking is needed.

■ When the shift lever is in **D**:

The shift mode goes into the 7-speed manual shift mode temporarily, and the number is displayed in the shift indicator.

The 7-speed manual shift mode is cancelled automatically if you drive at constant speed or accelerate, and the number in the shift indicator goes off.

You can cancel this mode by pulling the **+** paddle shifter for a few seconds.

The 7-speed manual shift mode is especially useful when reducing the vehicle speed temporarily before making a turn.

■ When the shift lever is in **S**:

The shift mode goes into the 7-speed manual shift mode. The **M** indicator and the speed number are displayed in the shift indicator. As the vehicle speed slows down, the transmission automatically shifts down accordingly. When the vehicle comes to a stop, it automatically shifts down into 1st.

If the vehicle speed increases and the engine speed reaches near the tachometer's red zone, the transmission automatically shifts up.

You can only pull away in 1st speed.

When canceling the 7-speed manual shift mode, move the shift lever from **S** to **D**. When the 7-speed manual shift mode is cancelled, the **M** indicator and shift indicator go off.

▶▶ 7-Speed Manual Shift Mode

To improve fuel economy, the transmission may shift up to a higher speed than the seventh under certain circumstances. In this case, the number in the shift indicator remains as 7.

In the 7-speed manual shift mode, the transmission shifts up or down by operating either paddle shifter under the following conditions:

Shift Up: The engine speed reaches the lowest threshold of the higher speed position.

Shift Down: The engine speed reaches the highest threshold of the lower speed position.

When the engine speed reaches near the tachometer's red zone, the transmission shifts up automatically.

When the engine speed reaches the lowest threshold of the selected speed position, the transmission shifts down automatically.

Operating the paddle shifters on slippery surfaces may cause the tyres to lock up. In this case, the 7-speed manual shift mode is cancelled and goes back to the normal D driving mode.

7-Speed Manual Shift Mode Operation

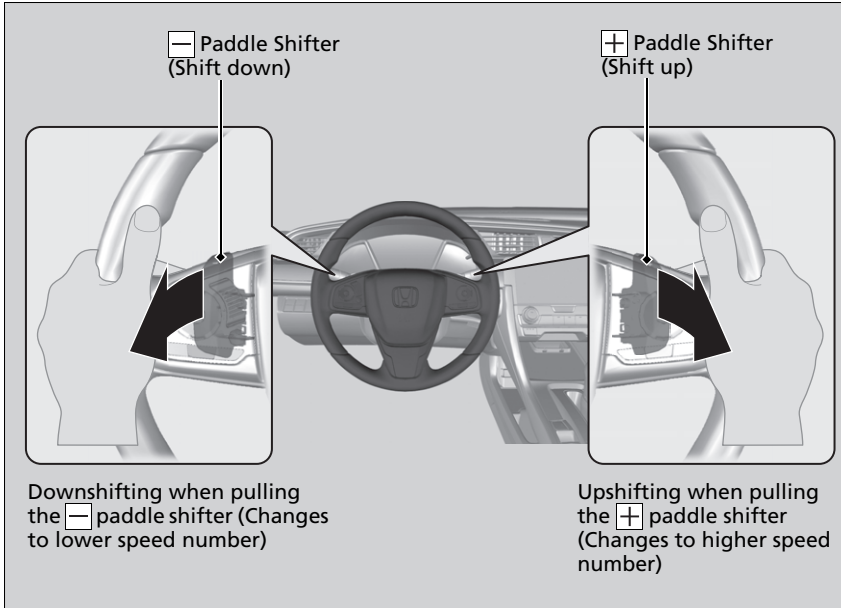

7-Speed Manual Shift Mode Operation

Each paddle shift operation makes a single speed change.

To change continuously, release the paddle shifter before pulling it again for the next speed.

The shift indicator blinks when you cannot shift up or down. It indicates that your vehicle speed is not in its allowable shifting range.

Slightly accelerate to shift up and decelerate to shift down while the indicator is blinking.

Shift Up/Down Indicators

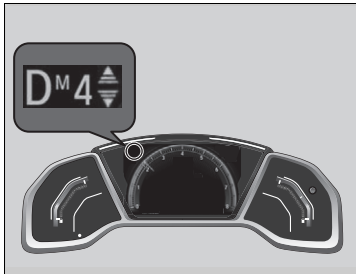

Come on while the vehicle is in the 7-speed manual shift mode to indicate when a speed change is appropriate to maintain the most fuel efficient driving style.

The shift up indicator: Comes on when shifting up is recommended.

The shift down indicator: Comes on when shifting down is recommended.

Shift Up/Down Indicators

⚠ WARNING

The shift indicator is only a guide to help you achieve better fuel economy. Never refer to the Shift Indicators when road and traffic conditions are unsuitable or when it may distract you.

The shift down indicator will not prompt you to downshift to increase engine braking. It is up to you to downshift to increase engine braking when driving downhill.

Always shift down at the appropriate vehicle speed.

When the ECON mode is on, ambient meter colour may change if you do not change speed positions when a shift indicator illuminates. This can result in a change in fuel economy.

Road and traffic conditions may require you to shift at times other than those indicated.

Manual transmission models

Shifting**Shift Lever Operation**

Fully depress the clutch pedal to operate the shift lever and change gears, then slowly release the pedal.

Depress the clutch pedal, and pause for a few seconds before shifting into **[R]**, or shift into one of the forward gears for a moment. This stops the gears so they do not “grind.”

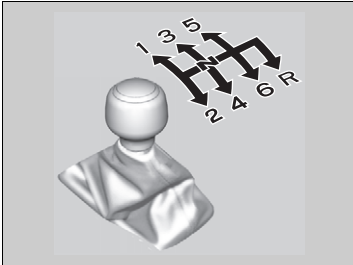

When you are not shifting, do not rest your foot on the clutch pedal. This can cause your clutch to wear out faster.

Shifting

NOTICE

Do not shift to **[R]** before the vehicle comes to a complete stop. Shifting to **[R]** before stopping can damage the transmission.

NOTICE

Before downshifting, make sure the engine will not go into the tachometer's red zone. Should this occur, it can severely damage your engine.

There is a metallic part on the shift lever. If you leave the vehicle parked outside for a long time on a hot day, be careful before moving the shift lever. Because of heat, the shift lever may be extremely hot. If the outside temperature is low, the shift lever may feel cold.

If you exceed the maximum speed for the gear you are in, the engine speed will enter into the tachometer's red zone. When this happens, you may experience a slight jolt.

Continued

■ Shift Up/Down Indicators*

Models with information display

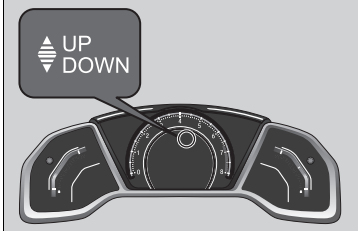

Models with driver information interface

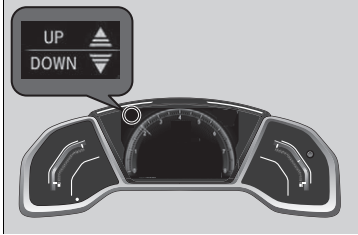

Come on to indicate when a gear change is appropriate to maintain the most fuel efficient driving style.

The shift up indicator: Comes on when shifting up is recommended.

The shift down indicator: Comes on when shifting down is recommended.

▶▶ Shift Up/Down Indicators*

⚠ WARNING

The shift indicator is only a guide to help you achieve better fuel economy. Never refer to the Shift Indicators when road and traffic conditions are unsuitable or when it may distract you.

This indicator will not prompt you to downshift to increase engine braking. It is up to you to downshift to increase engine braking when driving downhill.

Always shift down at the appropriate vehicle speed.

The shift down indicator does not come on when downshifting from **2** to **1**.

When the ECON mode is on, ambient meter colour may change if you do not change gears when a shift indicator illuminates. This can result in a change in fuel economy.

Road and traffic conditions may require you to shift at times other than those indicated.

Reverse Lockout

The manual transmission has a lockout mechanism that stops you from accidentally shifting into **R** from a forward gear while the vehicle is moving above a certain speed.

If you cannot shift to **R** when the vehicle is stopped, do the following:

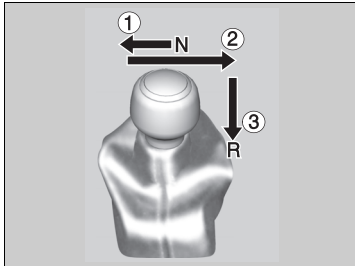

1. Depress the clutch pedal, move the shift lever all the way to the left, and shift to **R**.
2. If you still cannot shift into **R**, apply the electric parking brake, and turn the ignition switch to ACCESSORY **I** or LOCK **O***1.
3. Depress the clutch pedal and shift into **R**.
4. Keep depressing the clutch pedal and start the engine.

Have your vehicle checked by a dealer if you have to go through this procedure repeatedly.

*1: Models with the keyless access system have an **ENGINE START/STOP** button instead of an ignition switch.

Auto Idle Stop*

To help to maximise fuel economy, the engine automatically stops when the vehicle comes to a stop, depending on environmental and vehicle operating conditions. The indicator (green) comes on at this time. The engine then restarts once the vehicle is about to move again when you depress the clutch pedal, and the indicator (green) goes off.

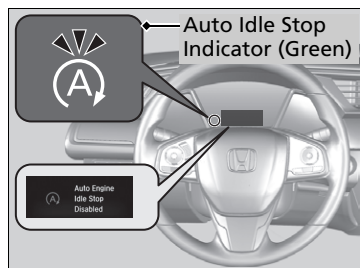

A message associated with Auto Idle Stop appears on the driver information interface.

➤ **Indicators** P. 94

➤ **Customized Features** P. 359

Auto Idle Stop may activate less frequently in such conditions as a traffic jam.

If the driver's door is opened while the indicator (green) is on, a buzzer sounds to notify you that the Auto Idle Stop function is in operation.

➤ Auto Idle Stop*

The 12-volt battery installed in this vehicle is specifically designed for a model with Auto Idle Stop. Using a 12-volt battery other than this specified type may shorten the battery life, and prevent Auto Idle Stop from activating. If you need to replace the battery, make sure to select the specified type. Ask a dealer for more details.

➤ **Specifications** P. 724

The duration of the Auto Idle Stop operation:

- **Increase** in the ECON mode, compared to when the ECON mode is off, with climate control in use.

Auto Idle Stop may activate less frequently in such conditions as a traffic jam.

Auto Idle Stop System ON/OFF

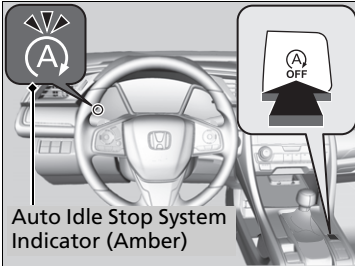

To turn the Auto Idle Stop system off, press this button. The Auto Idle Stop system stops.

- ▶ Auto Idle Stop system will stop and the indicator (amber) will come on.

The Auto Idle Stop system is turned on every time you start the engine, even if you turned it off the last time you drove the vehicle.

Auto Idle Stop System ON/OFF



Pressing the Auto Idle Stop **OFF** button restarts the engine during the Auto Idle Stop activated.

■ Auto Idle Stop Activates When:

After the vehicle moves forward, stopping with the brake, the clutch pedal is fully depressed, the shift lever in **[N]**, and then the clutch pedal released.

- ▶ To restart the engine automatically, depress the clutch pedal.

■ Auto Idle Stop does not activate when:

- The driver's seat belt is not fastened.
- The engine coolant temperature is low or high.
- The engine is started with the bonnet open.
 - ▶ Turn off the engine. Close the bonnet before you restart the engine to activate Auto Idle Stop.
-  is on (indicator (amber) on).
- The battery charge is low.
- The internal temperature of the battery is 5°C or less.
-  is on (indicator on).
- The climate control system temperature is set to **Hi** or **Lo**.
- The climate control system is in use, and the outside temperature is below -20°C or over 40°C.
- The shift lever is in any position except **[N]**.
- The engine restarts but the vehicle stops again before reaching 3 km/h.

▶▶ Auto Idle Stop Activates When:

Do not open a bonnet, during idling stop. If the bonnet is opened, the engine will not restart automatically.

In this case, restart the engine with the **ENGINE START/STOP** button or turn the ignition switch to **START [III]**.

➔ **Starting the Engine** P. 458, 461

Models with keyless access system

Pressing the **ENGINE START/STOP** button changes the power mode to **ACCESSORY** even while Auto Idle Stop is in operation. Once in **ACCESSORY**, the engine no longer restarts automatically. Follow the standard procedure to start the engine.

➔ **Starting the Engine** P. 461

Models without keyless access system

Even if you turn the ignition switch to **START [III]** during the Auto Idle Stop activated, the engine does not start.

■ Auto Idle Stop may not activate when:

- The steering wheel is operated.
- Altitude is high.
- The climate control system is in use, and there is a significant difference between the set temperature and the actual interior temperature.
- Humidity in the interior is high.
- The vehicle is repeatedly accelerated and decelerated at a low speed.
- The fan speed is high.
- The climate control system is in use, and humidity in the interior is high.

■ The Engine Automatically Restarts When:

The clutch pedal is depressed.

■ The engine automatically restarts even if the clutch pedal is not depressed with the shift lever in **N** when:

- The Auto Idle Stop **OFF** button is pressed.
- Your vehicle is moved.
- The pressure on the brake pedal is repeatedly applied and released slightly during a stop.
- The battery charge becomes low.
- The steering wheel is operated.
-  is selected (indicator on).
- The climate control system is in use, and the difference between the set temperature and actual interior temperature becomes significant.
- The climate control system is being used to dehumidify the interior.

▶▶ The Engine Automatically Restarts When:

If you are using an electronic device during Auto Idle Stop, the device may temporarily be turned off when the engine restarts.

The engine does not restart automatically when there is a problem in the system. Follow the normal procedure to start the engine.

▶ **Starting the Engine** P. 458, 461

The engine does not restart automatically when:

- The driver's seat belt is unlatched.
Fasten the driver's seat belt to keep the Auto Idle Stop activated.
- The shift lever is moved from **N** to any other position.
Shift to **N**.

▶ **Driver Information Interface Warning and Information Messages*** P. 126

When the system stops operating, follow the normal procedure to start the engine.

▶ **Starting the Engine** P. 458, 461

ECON Button

Models with information display

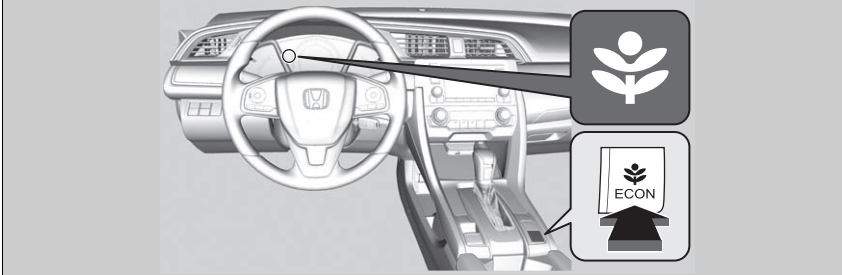

Models with driver information interface

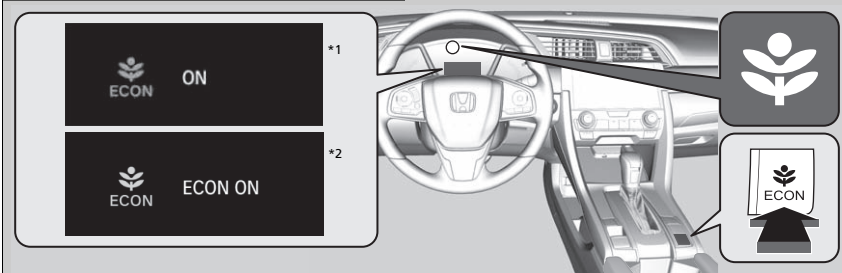

The **ECON** button turns the ECON mode on and off.

The ECON mode helps you improve your fuel economy by adjusting the performance of the engine, transmission, climate control system and cruise control*.

*1: Israeli, Turkish, and except Middle Eastern models

*2: Middle Eastern except Israeli and Turkish models

* Not available on all models

⊠ ECON Button

While in ECON mode, the climate control system has greater temperature fluctuations.

Models without Adjustable Speed Limiter

Cruise Control*

Maintains a constant vehicle speed without having to keep your foot on the accelerator pedal. Use cruise control on motorways or open roads where you can travel at a constant speed with little acceleration or deceleration.

When to use

- Vehicle speed for cruise control: Desired speed in a range above roughly 40 km/h ~

Always keep sufficient distance between you and the vehicle in front of you

Continuously variable transmission models

- Shift positions for cruise control: In **D** or **S**

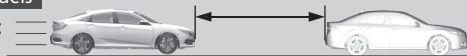

How to use

CRUISE MAIN is in the instrument panel
Cruise control is ready to use.

- Press the **CRUISE** button on the steering wheel.

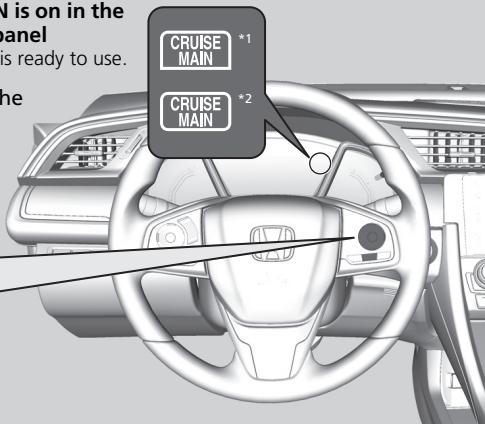

⊗ Cruise Control*

⚠ WARNING

Improper use of the cruise control can lead to a crash.

Use the cruise control only when travelling on open motorways in good weather.

It may not be possible to maintain a constant speed when driving uphill or downhill.

Manual transmission models

When the engine speed slows down, try to downshift.
You can maintain the set speed if you change gear within five seconds.

When not using cruise control:
Turn off cruise control by pressing the **CRUISE** button.

While in ECON mode, it may take relatively more time to accelerate to maintain the set speed.

*1 : Models with information display
*2 : Models with driver information interface
* Not available on all models

■ To Set the Vehicle Speed

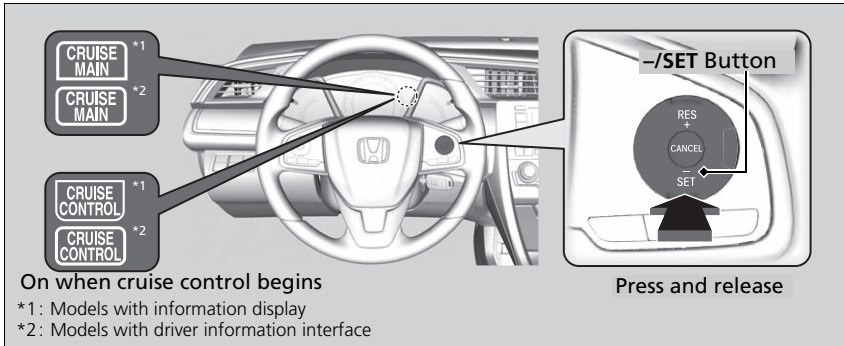

Take your foot off the accelerator pedal and press the **-/SET** button when you reach the desired speed.

The moment you release the **-/SET** button, the set speed is fixed, and cruise control begins. The **CRUISE CONTROL** indicator comes on.

During cruise control, Straight Driving Assist Function is activated. This control function is an EPS function and it helps reduce the steering effort to keep the steering angle on a straight road with cants.

■ To Adjust the Vehicle Speed

Increase or decrease the vehicle speed using the **RES/+** or **-/SET** buttons on the steering wheel.

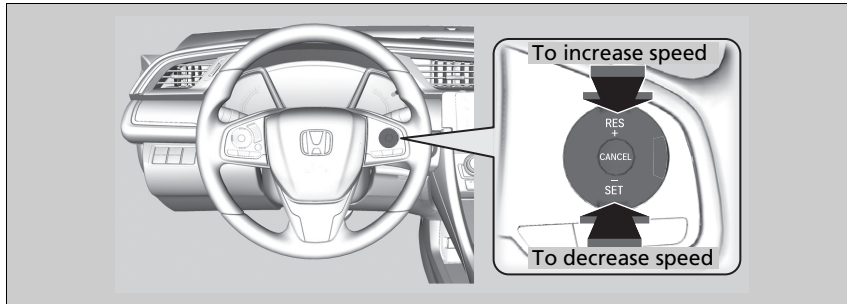

- Each time you press the button, the vehicle speed is increased or decreased by about 1.6 km/h.
- If you keep the button pressed, the vehicle speed increases or decreases until you release it. This speed is then set.

■ To Cancel

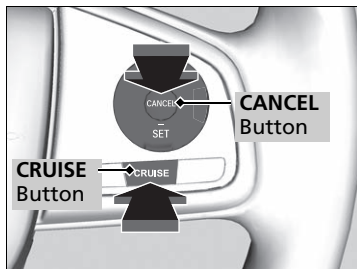

To cancel cruise control, do any of the following:

- Press the **CANCEL** button.
- Press the **CRUISE** button.
- Depress the brake pedal.
- Depress the clutch pedal* for five seconds or more.

The **CRUISE CONTROL** indicator goes off.

▶▶ To Adjust the Vehicle Speed

You can set the vehicle speed using the **-/SET** button on the steering wheel when adjusting the speed with the accelerator and brake pedals.

▶▶ To Cancel

Resuming the prior set speed:
After cruise control has been cancelled, you can still resume the prior set speed by pressing the **RES/+** button while driving at a speed of at least 40 km/h or more.

You cannot set or resume in the following situations:

- When vehicle speed is less than 40 km/h
- When the **CRUISE** button is turned off

At vehicle speeds of 35 km/h or less, cruise control is cancelled automatically.

Models with Adjustable Speed Limiter

Cruise Control*

Maintains a constant vehicle speed without having to keep your foot on the accelerator pedal. Use cruise control on motorways or open roads where you can travel at a constant speed with little acceleration or deceleration.

When to use

- Vehicle speed for cruise control: Desired speed in a range from about 30 km/h to about 200 km/h

Always keep sufficient distance between you and the vehicle in front of you

Continuously variable transmission models

- Shift positions for cruise control: In **D** or **S**

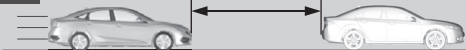

How to use

- Press the **MAIN** button on the steering wheel

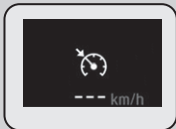

The indicator is on in the instrument panel
Cruise control is ready to use.

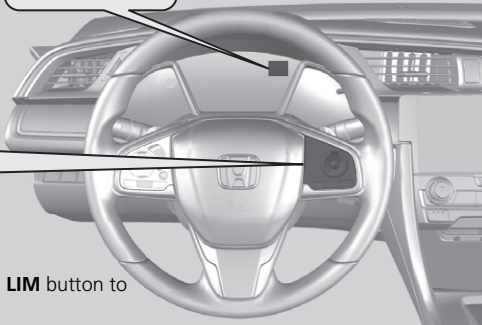

If a different indicator comes on, press the **LIM** button to switch to cruise control.

⚠Cruise Control*

⚠WARNING

Improper use of the cruise control can lead to a crash.

Use the cruise control only when travelling on open motorways in good weather.

It may not be possible to maintain a constant speed when driving uphill or downhill.

Manual transmission models

When the engine speed slows down, try to downshift.

You can maintain the set speed if you change gear within five seconds.

When not using cruise control: Turn off cruise control by pressing the **MAIN** button.

While in ECON mode, it may take relatively more time to accelerate to maintain the set speed.

You cannot use cruise control and the adjustable speed limiter at the same time.

* Not available on all models

Continued

■ To Set the Vehicle Speed

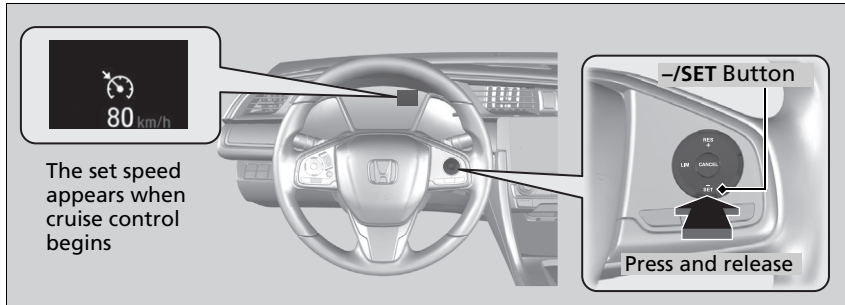

Take your foot off the accelerator pedal and press the **-/SET** button when you reach the desired speed.

The moment you release the **-/SET** button, the set speed is fixed, and cruise control begins. The set speed is displayed.

During cruise control, Straight Driving Assist Function is activated. This control function is an EPS function and it helps reduce the steering effort to keep the steering angle on a straight road with cants.

■ To Adjust the Vehicle Speed

Increase or decrease the vehicle speed using the **RES/+** or **-/SET** buttons on the steering wheel.

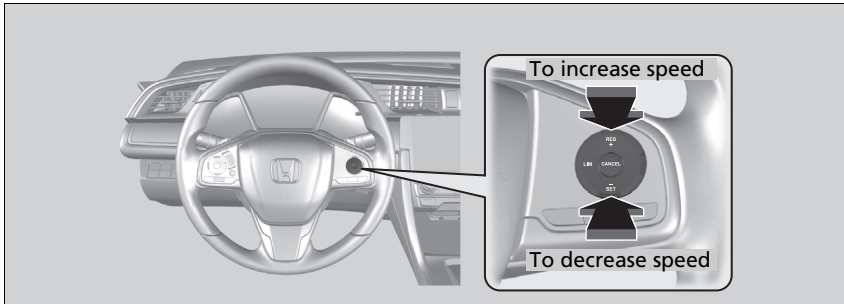

- Each time you press the button, the vehicle speed is increased or decreased by about 1 km/h.
- If you keep the button pressed, the vehicle speed increased or decreased by about 10 km/h.

■ To Cancel

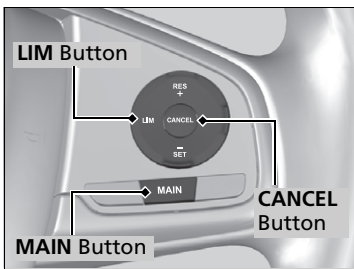

To cancel cruise control, do any of the following:

- Press the **CANCEL** button.
- Press the **MAIN** button.
- Press the **LIM** button.
- Depress the brake pedal.
- Depress the clutch pedal* for five seconds or more.

The displayed set speed goes off.

* Not available on all models

☒ To Adjust the Vehicle Speed

You can set the vehicle speed using the **-/SET** button on the steering wheel when adjusting the speed with the accelerator and brake pedals.

☒ To Cancel

Resuming the prior set speed:

After cruise control has been cancelled, you can still resume the prior set speed by pressing the **RES/+** button while driving at a speed of at least 30 km/h or more.

You cannot set or resume in the following situations:

- When vehicle speed is less than 30 km/h
- When the **MAIN** button is turned off

At vehicle speeds of 25 km/h or less, cruise control is cancelled automatically.

Adjustable Speed Limiter*

This system enables you to set a maximum speed that cannot be exceeded even if you are depressing the accelerator pedal.

The vehicle speed limit can be set from about 30 km/h to 250 km/h.

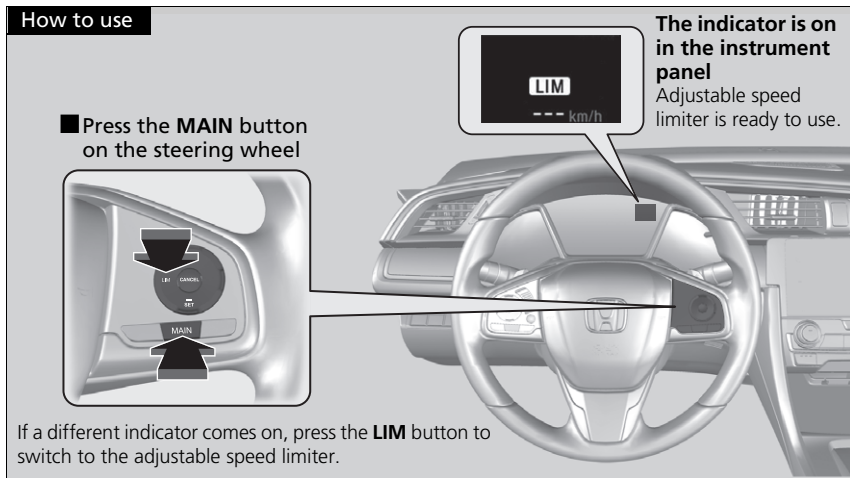

Adjustable Speed Limiter*

WARNING

Adjustable Speed Limiter has limitations. It is always your responsibility to adjust the vehicle speed to obey the actual speed limit, and safely operate the vehicle.

WARNING

Do not depress the accelerator pedal more than necessary. Maintain an appropriate accelerator pedal position depending on the vehicle speed.

The adjustable speed limiter may not hold the set speed limit when driving downhill. If this occurs, slow down by depressing the brake pedal.

When not using the adjustable speed limiter: Turn off the adjustable speed limiter by pressing the **MAIN** button.

You cannot use the adjustable speed limiter and the cruise control*/Adaptive Cruise Control (ACC) with LSF*/Intelligent Speed Limiter* at the same time.

Manual transmission models

When the engine speed slows down, try to downshift.

■ To Set the Vehicle Speed

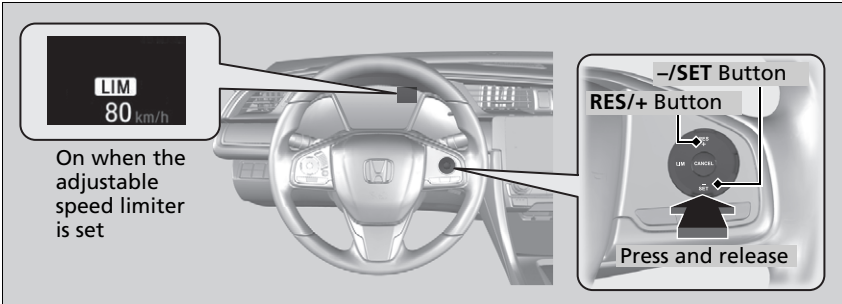

- Take your foot off the pedal and press the **-/SET** button when you reach the desired speed.
The moment you release the **-/SET** button, the set speed is fixed, and the adjustable speed limiter is set. The set speed is displayed.
- You can set the previously set speed limit by pressing the **RES/+** button.

☒ To Set the Vehicle Speed

If you set the speed limit while travelling at less than 30 km/h, the speed limit is set to 30 km/h.

The beeper sounds and the displayed speed limit blinks if the vehicle speed exceeds the limit by 3 km/h or more on a steep descent.

The adjustable speed limiter is set to the current speed if it is higher than the previously set speed limit when you press the **RES/+** button.

■ To Adjust the Speed Limit

Increase or decrease the speed limit by using the **RES/+** or **-/SET** buttons on the steering wheel.

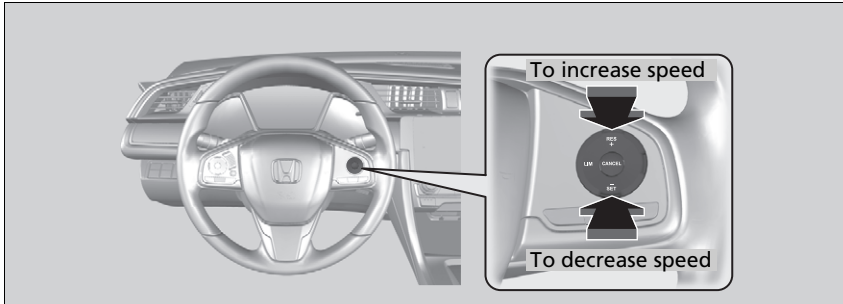

- Each time you press the button, the speed limit increases or decreases by 1 km/h accordingly.
- If you keep the button pressed, the speed limit increases or decreases in increments of 10 km/h every 0.5 second until system limit is reached.
- The vehicle may accelerate or decelerate until the set speed is reached.

■ Exceeding the Speed Limit Temporarily

The speed limit can be exceeded by depressing the accelerator pedal fully.

- ▶ The displayed limit speed blinks.
The beeper sounds once the speed limit has been exceeded.

⊠ Exceeding the Speed Limit Temporarily

The beeper sounds when the vehicle speed goes higher than the set speed limit with the acceleration pedal depressed completely.

The adjustable speed limiter resumes working once the vehicle speed goes lower than the set speed limit.

To Cancel

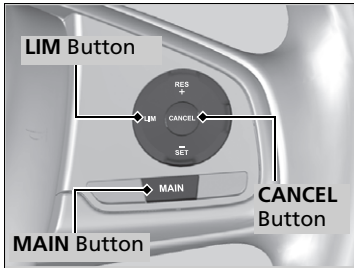

To cancel the adjustable speed limiter, do any of the following:

- Press the **CANCEL** button.
- Press the **MAIN** button.
- Press the **LIM** button.

▶▶ To Cancel

The adjustable speed limiter changes into cruise control if the **LIM** button is pressed.

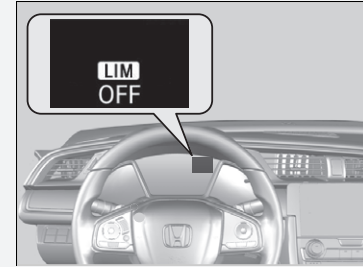

If there is a problem with the system when you are using the adjustable speed limiter, the beeper sounds and **OFF** comes on. The adjustable speed limiter will be turned off.

Models with traffic sign recognition system

Intelligent Speed Limiter

Automatically sets the speed limit that the traffic sign recognition system detects. And the speed limit cannot be exceeded even if you are depressing the accelerator pedal. If you fully depress the accelerator the speed limit can be exceeded.

➤ **Traffic Sign Recognition System*** P. 536

▶ Intelligent Speed Limiter

WARNING

Intelligent Speed Limiter has limitations. The Intelligent Speed Limiter may set itself to a speed above or below the actual speed limit, or may not work, particularly where the traffic sign recognition system does not operate correctly or where a road has no speed limit signs. It is always your responsibility to adjust the speed to obey the actual speed limit and to safely operate the vehicle.

Depending on the amount of depression of the accelerator pedal, the vehicle will accelerate until it reaches the speed identified by the traffic sign recognition system.

How to use

■ Press the **MAIN** button on the steering wheel

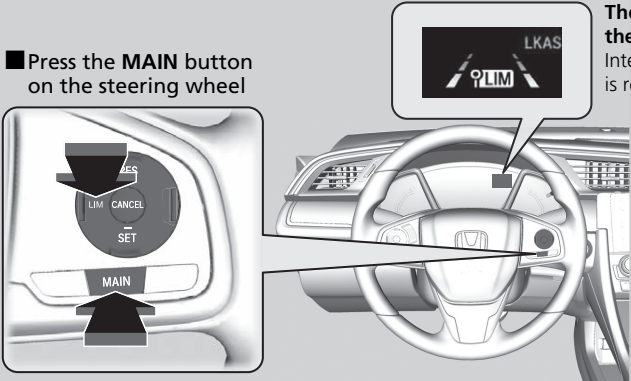

The indicator is on in the instrument panel
Intelligent speed limiter is ready to use.

If a different indicator comes on, press the **LIM** button to change it to the intelligent speed limiter.

⌘ Intelligent Speed Limiter

The system is designed to detect signs that follow the Vienna Convention standards. Not all signs may be detected, but any signs posted on roadsides should not be ignored. The system does not work on the designated traffic signs of all the countries you travel, nor in all situations.

⌘ **Traffic Sign Recognition System** * P. 536

If the intelligent speed limiter is set to the wrong speed limit, try one of the following:

To cancel

- Press the **CANCEL** button.
- Press the **MAIN** button.
- Press the **LIM** button.

To exceed the speed limit temporarily

- Depressing the accelerator pedal fully.

The intelligent speed limiter may not hold the set speed limit when driving downhill. If this occurs, slow down by depressing the brake pedal.

When not using the intelligent speed limiter, turn off the intelligent speed limiter by pressing the **MAIN** button.

You cannot use the intelligent speed limiter and ACC with LSF or adjustable speed limiter at the same time.

* Not available on all models

■ To Set the Speed Limit

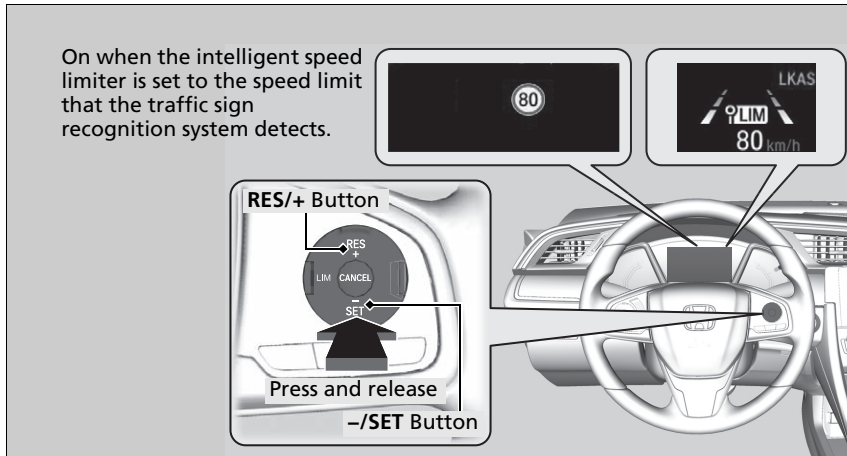

- The moment you release the **-/SET** button or **RES/+** button, the intelligent speed limiter is set to the speed limit that the traffic sign recognition system detects. The speed limit is displayed.

▶▶ Intelligent Speed Limiter

Manual transmission models

When the engine speed slows down, try to downshift.

Do not use the intelligent speed limiter in areas of different units from the display unit of the intelligent speed limiter.

Change the displayed measurement of the set vehicle speed to the same units as the driving areas.

▶ **Customized Features** P. 161

▶▶ To Set the Speed Limit

If you set the intelligent speed limiter when the speed limit that the traffic sign recognition system detects is less than 30 km/h, the speed limitation function and warning function may switch to pause.

If your vehicle speed is higher than the speed limit that the traffic sign recognition system detects, your vehicle decelerates slowly to the speed limit or less. If necessary, slow down by depressing the brake pedal. And the beeper sounds and the displayed speed limit blinks if the vehicle speed exceeds the limit by 3 km/h or more.

■ When the traffic sign recognition system detects the new speed limit sign

The intelligent speed limiter is set to the new speed limit that the traffic sign recognition system detects.

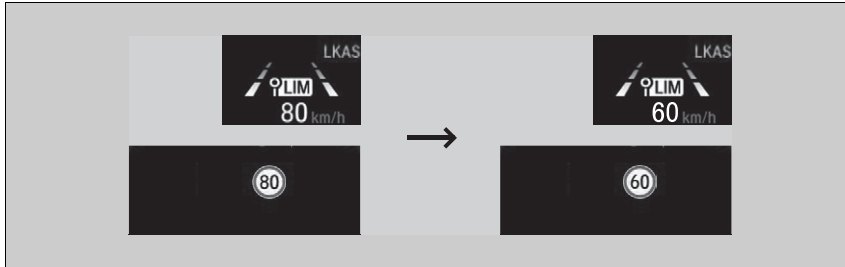

■ The speed limitation function and warning function may switch to pause if there is no speed limit sign in the screen of the traffic sign recognition system when:

- The end of speed limit or other designated limit is detected.
- Your vehicle enters/exits motorway or highway.
- You make a turn with a turn signal to change direction at an intersection.

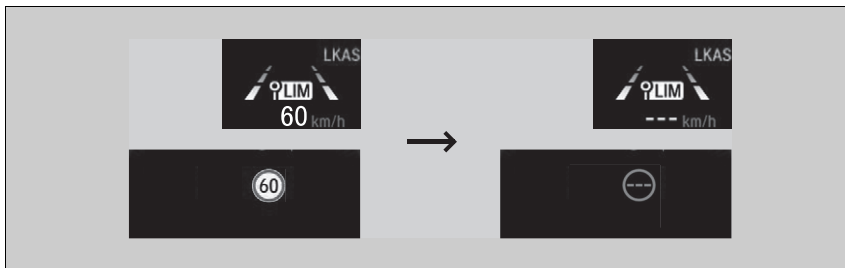

▶▶ To Set the Speed Limit

The intelligent speed limiter may also switch to pause when the traffic sign recognition system detects only additional speed limit signs.

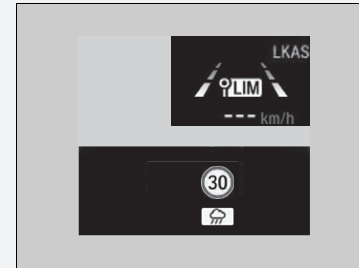

■ **When the traffic sign recognition system detects the speed limit sign while the intelligent speed limiter is paused**

The speed limitation function and warning function will be resumed automatically.

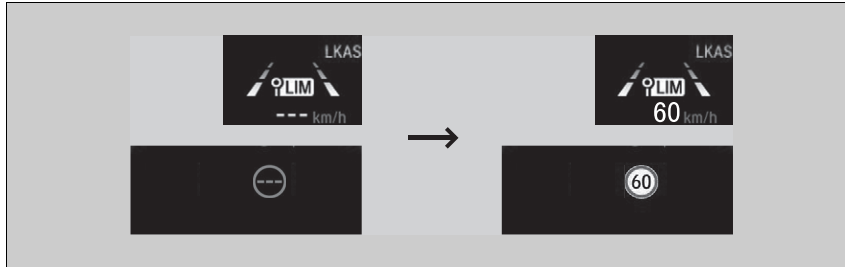

■ **When the traffic sign recognition system does not detect the speed limit sign for a time while the intelligent speed limiter is activated**

While driving, in addition to when the traffic sign recognition system detects no speed limit sign, the traffic sign recognition system may display no speed limit. But, intelligent speed limiter functions continue.

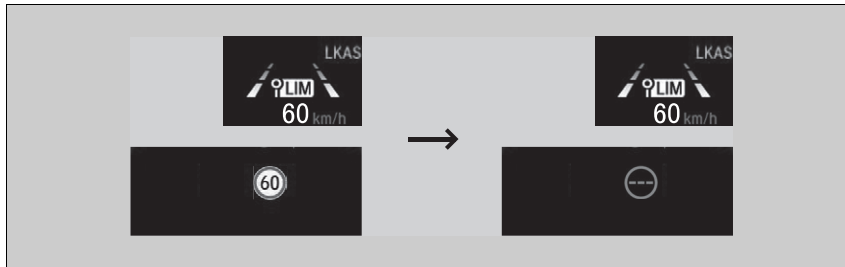

■ To Adjust the Speed Limit

Increase or decrease the speed limit by using the **RES/+** or **-/SET** buttons on the steering wheel.

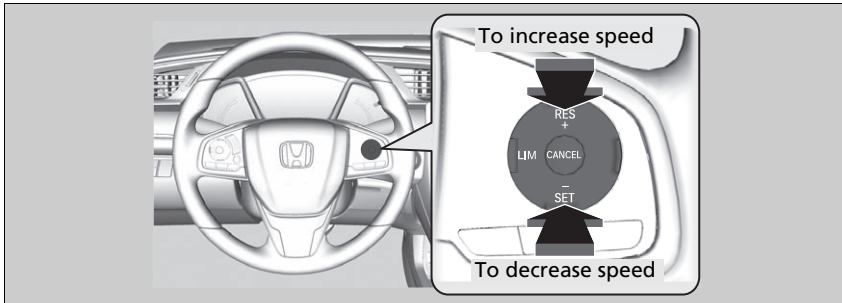

- Each time you press the button, the speed limit is increased or decreased by about 1 km/h accordingly.
- You can increase the speed limit until +10 km/h on the basis of the speed limit that the traffic sign recognition system detects.
- You can decrease the speed limit until -10 km/h on the basis of the speed limit that the traffic sign recognition system detects.
- You can accelerate until the set speed is reached. If your vehicle speed is higher than the speed limit that the traffic sign recognition system detects, your vehicle decelerates slowly to the speed limit.

■ Exceeding the Speed Limit Temporarily

The speed limit can be exceeded by depressing the accelerator pedal fully.

- ▶ The displayed speed limit blinks.
The beeper sounds once the speed limit has been exceeded.

▣ To Adjust the Speed Limit

A negative or positive offset with respect to the speed limit will be reset automatically when the traffic sign recognition system detects the new speed limit sign.

You cannot decrease the speed limit less than 30 km/h.

▣ Exceeding the Speed Limit Temporarily

The beeper sounds when the vehicle speed goes higher than the set speed limit with the acceleration pedal depressed completely.

The intelligent speed limiter resumes working once the vehicle speed goes lower than the set speed limit.

Continued

■ To Cancel

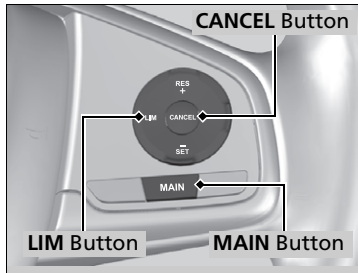

To cancel the intelligent speed limiter, do any of the following:

- Press the **CANCEL** button.
- Press the **MAIN** button.
- Press the **LIM** button.

▶▶ To Cancel

The intelligent speed limiter changes into cruise control if the **LIM** button is pressed.

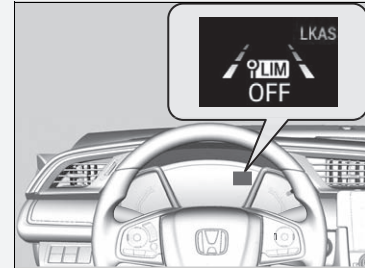

If there is a problem with the system or traffic sign recognition system when you are using the intelligent speed limiter, the beeper sounds and **OFF** comes on. The intelligent speed limiter will be turned off.

▶ **Traffic Sign Recognition System** * P. 536

Front Sensor Camera*

The camera, used in systems such as Lane Keeping Assist System (LKAS), Road Departure Mitigation System, Adaptive Cruise Control (ACC) with Low Speed Follow (LSF)*, Adaptive Cruise Control (ACC)*, Traffic Sign Recognition System, Collision Mitigation Braking System (CMBS), and auto high-beam, is designed to detect an object that triggers any of the systems to operate its functions.

Camera Location and Handling Tips

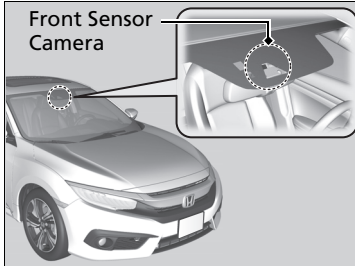

This camera is located behind the rearview mirror.

To help reduce the likelihood that high interior temperatures will cause the camera's sensing system to shut off, when parking, find a shady area or face the front of the vehicle away from the sun. If you use a reflective sun shade, do not allow it to cover the camera housing.

Covering the camera can concentrate heat on it.

Front Sensor Camera*

Never apply a film or attach any objects to the windshield, the bonnet, or the front grill that could obstruct the camera's field of vision and cause the system to operate abnormally.

Scratches, nicks, and other damage to the windshield within the camera's field of vision can cause the system to operate abnormally. If this occurs, we recommend that you replace the windshield with a genuine Honda replacement windshield. Making even minor repairs within the camera's field of vision or installing an aftermarket replacement windshield may also cause the system to operate abnormally.

After replacing the windshield, have a dealer recalibrate the camera. Proper calibration of the camera is necessary for the system to operate properly.

Do not place an object on the top of the instrument panel. It may reflect onto the windshield and prevent the system from detecting lane lines properly.

» Front Sensor Camera*

If the  message appears:

- Use the climate control system to cool down the interior and, if necessary, also use defroster mode with the airflow directed towards the camera.
- Start driving the vehicle to lower the windscreen temperature, which cools down the area around the camera.

If the  message appears:

- Park your vehicle in a safe place, and clean the windscreen. If the message does not disappear after you have cleaned the windscreen and driven for a while, have your vehicle checked by a dealer.

Continuously variable transmission models

Adaptive Cruise Control (ACC) with Low Speed Follow (LSF)*

Helps maintain a constant vehicle speed and a set following interval behind a vehicle detected ahead of yours and, if the detected vehicle comes to a stop, can decelerate and stop your vehicle, without you having to keep your foot on the brake or the accelerator.

When ACC with LSF slows your vehicle by applying the brakes, your vehicle's brake lights will illuminate.

When to use

The camera is located behind the rearview mirror.

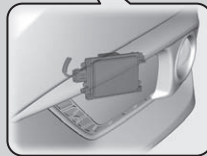
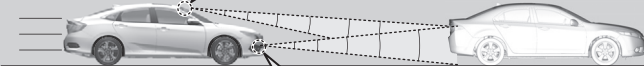
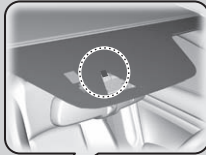

The radar sensor is in the lower bumper next to the fog light*. Be careful not to hit the radar sensor cover. Strong impact can damage it.

- Vehicle speed for ACC with LSF: **A vehicle is detected ahead within ACC with LSF range** – ACC with LSF operates at speeds up to 180 km/h.
No vehicle is detected within ACC with LSF range – ACC with LSF operates at the speed of 30 km/h or above.
- Shift position for ACC with LSF: In **D** or **S**.

⚠ Adaptive Cruise Control (ACC) with Low Speed Follow (LSF)*

⚠ WARNING

Improper use of ACC with LSF can lead to a crash.

Use ACC with LSF only when driving on motorway and in good weather conditions.

⚠ WARNING

ACC with LSF has limited braking capability and may not stop your vehicle in time to avoid a collision with a vehicle that quickly stops in front of you.

Always be prepared to apply the brake pedal if the conditions require.

Important Reminder

As with any system, there are limits to ACC with LSF. Use the brake pedal whenever necessary, and always keep a safe distance between your vehicle and other vehicles.

* Not available on all models

■ How to activate the system

How to use

ACC (green) is on in the instrument panel.
ACC with LSF is ready to use.

■ Press the **MAIN** button on the steering wheel.

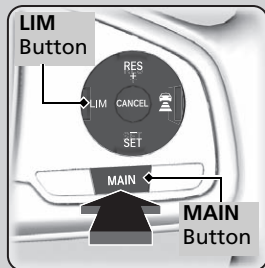

If a different instrument panel is displayed, press the **LIM** button to change it to ACC with LSF.

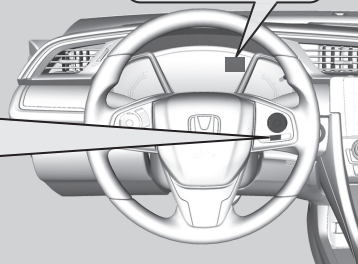
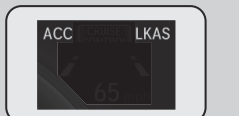

▶ Adaptive Cruise Control (ACC) with Low Speed Follow (LSF)*

When the **MAIN** button is pressed, both ACC with LSF and the Lane Keeping Assist System (LKAS) are either turned on or off.

ACC with LSF may not work properly under certain conditions.

▶ **ACC with LSF Conditions and Limitations**
P. 509

When not using ACC with LSF: Turn off adaptive cruise by pressing the **MAIN** button. This also will turn off the Lane Keeping Assist System (LKAS).

Do not use ACC with LSF under the following conditions:

- On roads with heavy traffic or while driving in continuous stop and go traffic.
- On roads with sharp turns.
- On roads with steep downhill sections, as the set vehicle speed can be exceeded by coasting. In such cases, ACC with LSF will not apply the brakes to maintain the set speed.
- On roads with toll collection facilities or other objects between lanes of traffic, or in parking areas, or facilities with drive through access.

■ To Set the Vehicle Speed

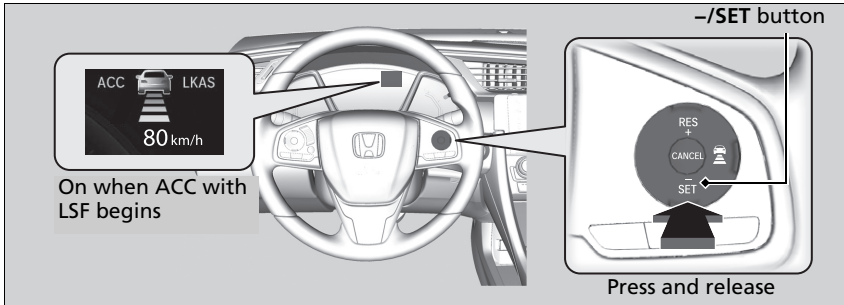

When driving at 30 km/h or above: Take your foot off the pedal and press the **-/SET** button when you reach the desired speed. The moment you release the button, the set speed is fixed, and ACC with LSF begins.

When driving slower than 30 km/h: If the vehicle is moving and the brake pedal is not depressed, pressing the button fixes the set speed to 30 km/h regardless of current vehicle speed. If your vehicle is stationary and a vehicle is detected ahead, your vehicle speed can be set, even with the brake pedal depressed.

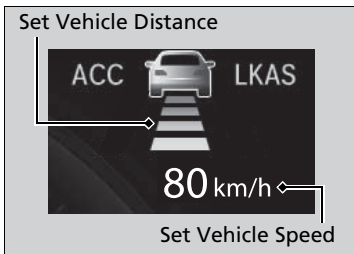

When ACC with LSF starts operating, the vehicle icon, distance bars and set speed appear on the driver information interface.

During cruise control, Straight Driving Assist Function is activated. This control function is an EPS function and it helps reduce the steering effort to keep the steering angle on a straight road with cants.

Continued

■ When in Operation

■ There is a vehicle ahead

ACC with LSF monitors if a vehicle ahead of you enters the ACC with LSF range. If a vehicle is detected doing so, the ACC with LSF system maintains or decelerates your vehicle's set speed in order to keep the vehicle's set following interval from the vehicle ahead.

➤ To Set or Change Following Interval P. 512

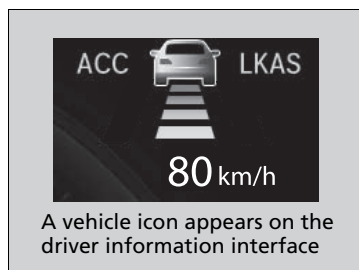
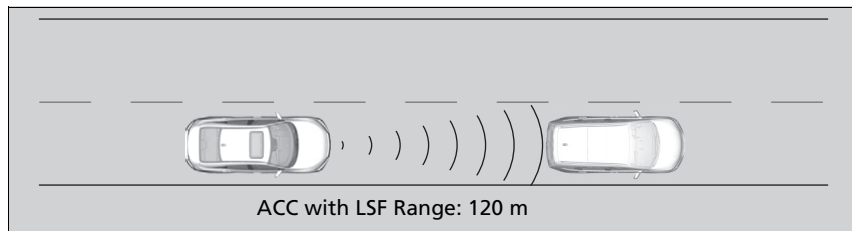

When a vehicle whose speed is slower than your set speed is detected in front of you, your vehicle starts to slow down.

⌘ When in Operation

If the vehicle ahead of you slows down abruptly, or if another vehicle cuts in front of you, the beeper sounds, a message appears on the driver information interface.

Depress the brake pedal, and keep an appropriate distance from the vehicle ahead.

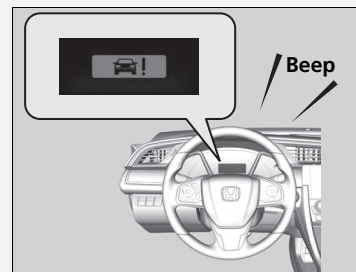

Even if the distance between your vehicle and the vehicle ahead is short, ACC with LSF may start accelerating your vehicle under the following circumstances:

- The vehicle ahead of you is going at almost the same speed as, or faster than, your vehicle.
- A vehicle that cuts in front of you is going faster than your vehicle, gradually increasing the distance between the vehicles.

You can also set the system to beep when a vehicle in front of you comes in and goes out of the ACC with LSF detecting range. Change the **ACC Vehicle Ahead Detected Beep** setting.

➤ Customized Features P. 359

■ **There is no vehicle ahead**

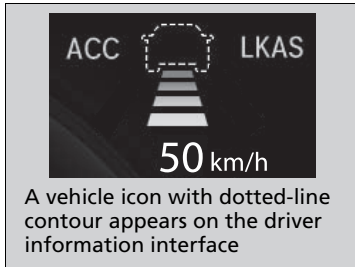

Your vehicle maintains the set speed without having to keep your foot on the brake or accelerator pedal. If there previously was a vehicle detected ahead that kept your vehicle from travelling at the set speed, ACC with LSF accelerates your vehicle to the set speed, and then maintains it.

■ **When you depress the accelerator pedal**

You can temporarily increase the vehicle speed. In this case, there is no audible or visual alert even if a vehicle is in the ACC with LSF range. ACC with LSF stays on unless you cancel it. Once you release the accelerator pedal, the system an appropriate speed for keeping the following interval while a vehicle ahead is within the ACC with LSF range.

⌘ When in Operation

Limitations

You may need to use the brake to maintain a safe distance when using ACC with LSF. Additionally, ACC with LSF may not work properly under certain conditions.

➤ **ACC with LSF Conditions and Limitations**
P. 509

■ A vehicle detected ahead is within ACC with LSF range and slows to a stop

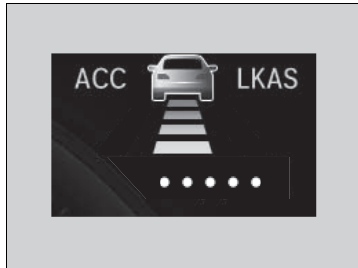

Your vehicle also stops, automatically. The **•••••** message appears on the driver information interface.

When the vehicle ahead of you starts again, the vehicle icon on the driver information interface blinks. If you press the **RES/+** or **-/SET** button, or depress the accelerator pedal, ACC with LSF operates again within the prior set speed.

If no vehicle is ahead of you before you resume driving, depress the accelerator pedal and ACC with LSF will operate again within the prior set speed.

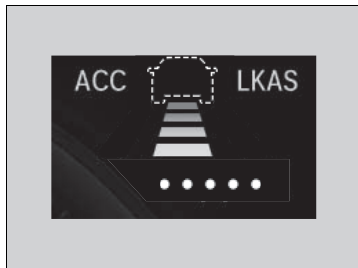

▶▶ When in Operation

⚠ WARNING

Exiting a vehicle that has been stopped while the ACC with LSF system is operating can result in the vehicle moving without operator control.

A vehicle that moves without operator control can cause a crash, resulting in serious injury or death.

Never exit a vehicle when the vehicle is stopped by ACC with LSF.

ACC with LSF Conditions and Limitations

The system may automatically shut off and the **ACC** indicator will come on under certain conditions. Some examples of these conditions are listed below. Other conditions may reduce some of the ACC functions.

➤ **Front Sensor Camera*** P. 501

■ Environmental conditions

- Driving in bad weather (rain, fog, snow, etc.).

■ Roadway conditions

- Driving on a snowy or wet roadway (obscured lane marking, vehicle tracks, reflected lights, road spray, high contrast).

■ Vehicle conditions

- The outside of the windscreen is blocked by dirt, mud, leaves, wet snow, etc.
- An abnormal tyre or wheel condition (Wrong size, varied size or construction, improperly inflated, compact spare tyre*, etc.).
- The camera temperature gets too high.
- The electric parking brake is applied.
- When the lower bumper next to the fog light* is dirty.
- The vehicle is tilted due to a heavy load or suspension modifications.
- When tyre chains are installed.

* Not available on all models

⊞ ACC with LSF Conditions and Limitations

The radar sensor for ACC with LSF is shared with the collision mitigation braking system (CMBS).

➤ **Collision Mitigation Braking System (CMBS)*** P. 569

You can read about handling information for the camera equipped with this system.

➤ **Front Sensor Camera*** P. 501

Always keep the radar sensor cover clean.

Never use chemical solvents or polishing powder for cleaning the sensor cover. Clean it with water or a mild detergent.

Do not put a sticker on the radar sensor cover or replace the radar sensor cover.

If you need the radar sensor to be repaired, or removed, or the radar sensor cover is strongly impacted, turn off the system by pressing the **MAIN** button and take your vehicle to a dealer.

Have your vehicle checked by a dealer if you find any unusual behaviour of the system (e.g., the warning message appears too frequently).

■ Detection limitations

- A vehicle suddenly crosses in front of you.
- The interval between your vehicle and the vehicle ahead of you is too short.
- A vehicle cuts in front of you at a slow speed, and it brakes suddenly.
- When you accelerate rapidly and approach the vehicle ahead of you at high speed.
- The vehicle ahead of you is a motorcycle, bicycle, mobility scooter, or other small vehicle.
- When there are animals in front of your vehicle.
- When you drive on a curved or winding or undulating road that makes it difficult for the sensor to properly detect a vehicle in front of you.
- The speed difference between your vehicle and a vehicle in front of you is significantly large.
- An oncoming vehicle suddenly comes in front of you.
- Your vehicle abruptly crosses over in front of an oncoming vehicle.
- When driving through a narrow iron bridge.
- When the vehicle ahead of you brakes suddenly.
- When the vehicle ahead of you has a unique shape.
- When your vehicle or the vehicle ahead of you is driving on one edge of the lane.

▣ ACC with LSF Conditions and Limitations

If the front of the vehicle is impacted in any of the following situations, the radar sensor may not work properly. Have your vehicle checked by a dealer:

- The vehicle mounted onto a bump, curb, chock, embankment, etc.
- You drive the vehicle where the water is deep.
- Your vehicle has a frontal collision.

■ To Adjust the Vehicle Speed

Increase or decrease the vehicle speed using the **RES/+** or **-/SET** button on the steering wheel.

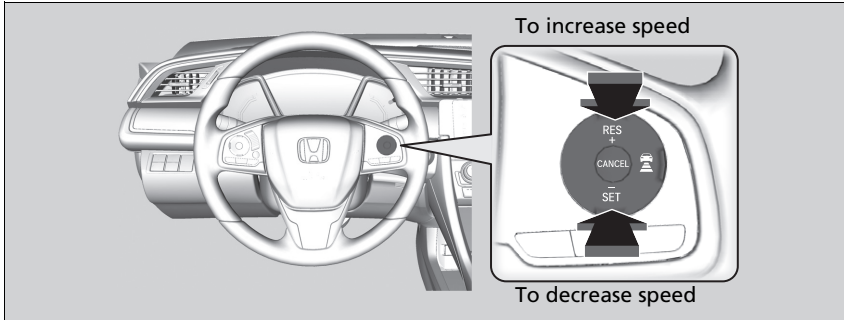

- Each time you press the **RES/+** or **-/SET** button, the vehicle speed is increased or decreased by about 1 km/h accordingly.
- If you keep pressing the **RES/+** or **-/SET** button, the vehicle speed increases or decreases by about 10 km/h accordingly.

☒ To Adjust the Vehicle Speed

If a vehicle detected ahead is going at a speed slower than your increased set speed, ACC with LSF may not accelerate your vehicle. This is to maintain the set interval between your vehicle and the vehicle ahead.

When you depress the accelerator pedal and then push and release the **-/SET** button, the current speed of the vehicle is set.

■ To Set or Change Following Interval

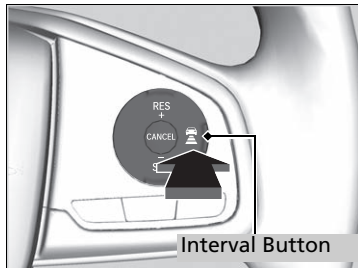





Press the  (Interval) button to change the ACC with LSF following interval.

Each time you press the button, the following-interval (the interval behind a vehicle detected ahead of you) setting cycles through extra long, long, middle, and short following intervals.

Determine the most appropriate following-interval setting based on your specific driving conditions. Be sure to adhere to any following-interval requirements set by local regulation.

The higher your vehicle's following-speed is, the longer the short, middle, long or extra long following interval becomes. See the following examples for your reference.

Following Interval		When the Set Speed is:	
		80 km/h	104 km/h
Short		25 meters 1.1 sec	31.5 meters 1.1 sec
Middle		33 meters 1.5 sec	43.4 meters 1.5 sec
Long		47 meters 2.1 sec	60.8 meters 2.1 sec
Extra Long		62 meters 2.8 sec	81.4 meters 2.8 sec

When your vehicle stops automatically because a vehicle detected ahead of you has stopped, the distance between the two vehicles will vary based on the ACC with LSF distance setting.

☒ To Set or Change Following Interval

The driver must in all circumstances preserve a sufficient braking distance from the vehicle which precedes it and be aware that minimum distances or times of spacing can be provided by the provisions of the Motorway Code locally applicable and that it is the driver's responsibility to respect those laws.

■ To Cancel

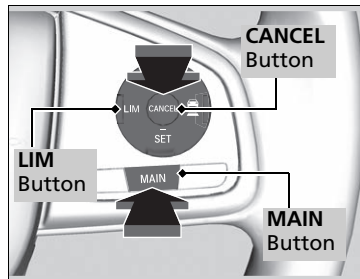

To cancel ACC with LSF, do any of the following:

- Press the **CANCEL** button.
- Press the **MAIN** button.
 - ▶ ACC with LSF indicator goes off.
- Press the **LIM** button.
- Depress the brake pedal.
 - ▶ When the LSF function has stopped the vehicle, you cannot cancel ACC with LSF by depressing the brake pedal.

▶▶ To Cancel

Resuming the prior set speed: After you have cancelled ACC with LSF, you can resume the prior set speed while it is still displayed. Press the **RES/+** button.

The set speed cannot be set or resumed when ACC with LSF has been turned off using the **MAIN** button. Press the **MAIN** button to activate the system, then set the desired speed.

■ Automatic cancellation

The beeper sounds and a message appears on the driver information interface when ACC with LSF is automatically cancelled. Any of these conditions may cause the ACC with LSF to automatically cancel:

- Bad weather (rain, fog, snow, etc.)
- When the radar sensor in the lower bumper next to the fog light gets dirty.
- The vehicle ahead of you cannot be detected.
- An abnormal tyre condition is detected, or the tyres are skidding.
- Driving on a mountainous road, or driving off road for extended periods.
- Abrupt steering wheel movement.
- When the ABS, VSA or CMBS is activated.
- When the ABS or VSA system indicator comes on.
- When the vehicle is stopped on a very steep slope.
- When you manually apply the electric parking brake.
- When the detected vehicle within the ACC with LSF range is too close to your vehicle.
- The camera behind the rearview mirror, or the area around the camera, including the windscreen, gets dirty.
- When the Maximum Load Limit is exceeded.
- When passing through an enclosed space, such as tunnel.

The ACC with LSF automatic cancellation can be also triggered by the following causes. In these cases, the electric parking brake will be automatically applied.

- The driver's seat belt is unfastened when the vehicle is stationary.
- The vehicle stops for more than 10 minutes.
- The engine is turned off.

⌘ Automatic cancellation

Even though ACC with LSF has been automatically cancelled, you can still resume the prior set speed. Wait until the condition that caused ACC with LSF to cancel improves, then press the **-/SET** button.

■ Intelligent Adaptive Cruise Control Function

Provides an early prediction for a cut-in situation. The system detects that a vehicle running in the adjacent slower lane has an intention to cut in front of you and adjusts the speed of your vehicle in advance while ACC with LSF is activated.

■ How the system works

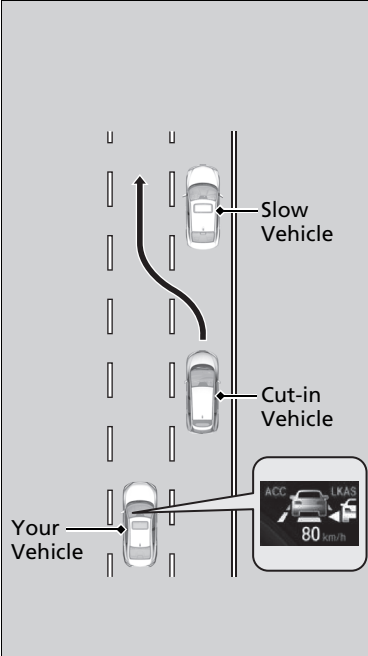

The radar sensor in the lower bumper next to the fog light* detects vehicles ahead of you including those in the adjacent lane, and the camera behind the rearview mirror detects the lane markings.

This system improves ACC with LSF's following/tracking property; it adjusts your vehicle speed in advance predicting a situation that a vehicle running in the adjacent slower lane catches up with a slower vehicle ahead of it and changes the lane to cut in front of you early.

When such a cut-in situation is predicted, your vehicle speed decreases a little. When detected, your vehicle speed decreases according to the vehicle cutting in front of you.

As the speed is adjusted by the system, the cut in vehicle icon appears on the driver information interface to indicate that the system is activated.

■ How the system activates

When a vehicle cuts in front of you is going faster than the vehicle ahead of it, and your vehicle is going faster than the cut-in vehicle (i.e., when you need to slow down), ACC with LSF predicts the cutting-in and adjust your vehicle speed.

The system activates when all the following conditions are met:

- When ACC with LSF is activated.
- When you are driving on a multi-lane road.
- When your vehicle speed is between about 80 km/h and about 180 km/h.
- The vehicle is on a straight or slightly curved road.
- The turn signals are off.
- The brake pedal is not depressed.
- When a vehicle cuts in from a slower lane.

■ Intelligent adaptive cruise control on and off

You can turn the system on and off using the driver information interface.

📖 **Customized Features*** P. 161, 359

📖 Intelligent Adaptive Cruise Control Function

When traffic changes from right hand side to left hand side, driving on a road where there is oncoming traffic for some distance automatically switches the lane to be detected from right to left.

Intelligent adaptive cruise control may not activate under the following conditions:

- When the speed difference between the cut-in vehicle and the vehicle ahead of it in the adjacent lane is small
- When the speed difference between the cut-in vehicle and your vehicle is small (i.e., when speed adjustment is not required)
- When a vehicle simply cuts in front of your vehicle with no vehicle ahead in the adjacent lane
- When a vehicle cuts in from a faster lane

* Not available on all models

Manual transmission models

Adaptive Cruise Control (ACC)*

Helps maintain a constant vehicle speed and a set following-interval behind a vehicle detected ahead of yours, without you having to keep your foot on the brake or the accelerator.

When ACC slows your vehicle by applying the brakes, your vehicle's brake lights will illuminate.

When to use

The camera is located behind the rearview mirror.

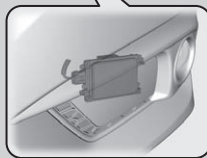
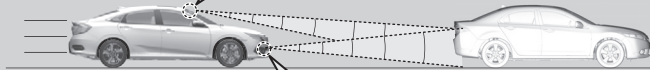
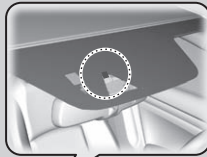

The radar sensor is in the lower bumper next to the fog light*.

■ Vehicle speed for adaptive cruise control:
Desired speed in a range above roughly
30 km/h ~

▶ Adaptive Cruise Control (ACC)*

⚠ WARNING

Improper use of ACC can lead to a crash.

Use ACC only when driving on motorways and in good weather conditions.

⚠ WARNING

ACC has limited braking capability. When your vehicle speed drops below 25 km/h, ACC will automatically cancel and no longer will apply your vehicle's brakes. Always be prepared to apply the brake pedal when conditions require.

Important Reminder

As with any system, there are limits to ACC. Use the brake pedal whenever necessary, and always keep a safe interval between your vehicle and other vehicles.

How to use

■ Press the **MAIN** button on the steering wheel.

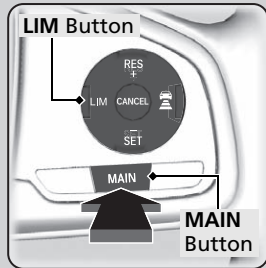

ACC (green) is on in the instrument panel.
ACC is ready to use.

If a different instrument panel is displayed, press the **LIM** button to change it to ACC.

▶ Adaptive Cruise Control (ACC)*

ACC may not work properly under certain conditions.

▶ **ACC Conditions and Limitations** P. 523

When not using ACC: Turn off adaptive cruise by pressing the **MAIN** button. This also will turn off the Lane Keeping Assist System (LKAS).

When the **MAIN** button is pressed, ACC and Lane Keeping Assist System (LKAS) are both turned on or off.

Do not use the ACC under the following conditions:

- On roads with heavy traffic or while driving in continuous stop and go traffic.
- On roads with sharp turns.
- On roads with steep downhill sections, as the set vehicle speed can be exceeded by coasting. In such cases, ACC will not apply the brakes to maintain the set speed.
- On roads with toll collection facilities or other objects between lanes of traffic, or in parking areas, or facilities with drive through access.

* Not available on all models

■ To Set the Vehicle Speed

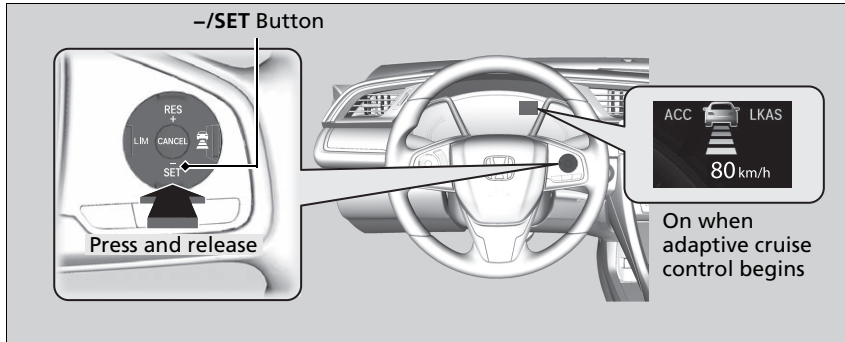

Take your foot off the pedal and press the **-/SET** button when you reach the desired speed.

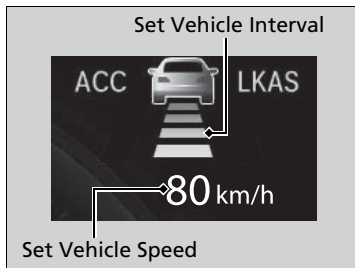

The moment you release the **-/SET** button, the set speed is fixed, and ACC begins.

When ACC starts operating, the vehicle icon, interval bars and set speed appear on the driver information interface.

During cruise control, Straight Driving Assist Function is activated. This control function is an EPS function and it helps reduce the steering effort to keep the steering angle on a straight road with cants.

▶ Adaptive Cruise Control (ACC)*

When the engine speed slows down, try to downshift. You can maintain the set speed if you change gear within five seconds.

It may take more time to accelerate in ECON mode.

You cannot use cruise control and the adjustable speed limiter at the same time.

You cannot use the ACC and the adjustable speed limiter at the same time.

■ When in Operation

■ There is a vehicle ahead

ACC monitors if a vehicle ahead of you enters the ACC range. If a vehicle is detected doing so, the ACC system maintains or decelerates your vehicle's set speed in order to keep the vehicle's set following-interval from the vehicle ahead.

🔧 **To Set or Change Following-interval** P. 526

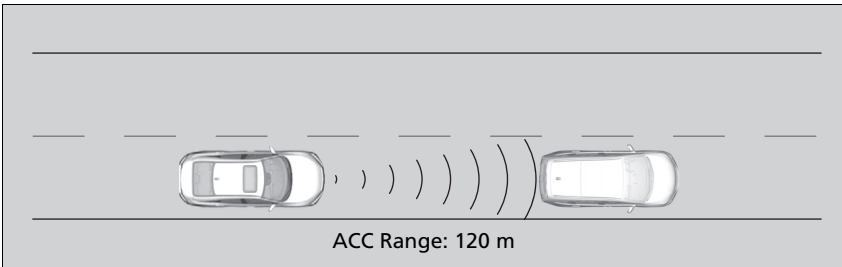

When a vehicle whose speed is slower than your set speed comes in or cuts in front of you and is detected by the radar and the camera, your vehicle starts to slow down.

🔧 When in Operation

If the vehicle ahead of you slows down abruptly, or if another vehicle cuts in front of you, the beeper sounds and a message appears on the driver information interface.

Depress the brake pedal, and keep an appropriate interval from the vehicle ahead.

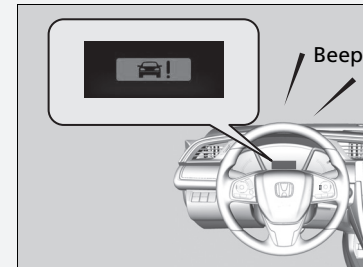

■ There is no vehicle ahead

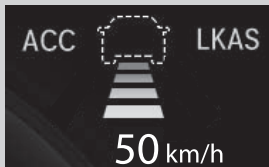

A vehicle icon with dotted-line contour appears on the driver information interface

■ When you depress the accelerator pedal

You can temporarily increase the vehicle speed. In this case, there is no audible or visual alert even if a vehicle is in the ACC range. ACC stays on unless you cancel it. Once you release the accelerator pedal, the system resumes an appropriate speed for keeping the following interval while a vehicle ahead is within the ACC range.

Your vehicle maintains the set speed without having to keep your foot on the brake or accelerator pedal.

If there previously was a vehicle detected ahead that kept your vehicle from travelling at the set speed, ACC accelerates your vehicle to the set speed, and then maintains it.

⌘ When in Operation

Even if the interval between your vehicle and the vehicle detected ahead is short, ACC may start accelerating your vehicle under the following circumstances:

- The vehicle ahead of you is going at almost the same speed as, or faster than, your vehicle.
- A vehicle that cuts in front of you is going faster than your vehicle, gradually increasing the interval between the vehicles.

You can also set the system to beep when a vehicle detected in front of you comes in and goes out of the ACC detecting range. Change the **ACC Vehicle Ahead Detected Beep** setting.

➤ **Customized Features*** P. 161, 359

Limitations

You may need to use the brake to maintain a safe interval when using ACC. Additionally, ACC may not work properly under certain conditions.

➤ **ACC Conditions and Limitations** P. 523

■ ACC Conditions and Limitations

The system may automatically shut off and the **ACC** indicator will come on under certain conditions. Some examples of these conditions are listed below. Other conditions may reduce some of the ACC functions.

➤ **Front Sensor Camera*** P. 501

■ Environmental conditions

Driving in bad weather (rain, fog, snow, etc.).

■ Roadway conditions

Driving on a snowy or wet roadway (obscured lane marking, vehicle tracks, reflected lights, road spray, high contrast).

■ Vehicle conditions

- The outside of the windscreen is blocked by dirt, mud, leaves, wet snow, etc.
- An abnormal tyre or wheel condition (Wrong sized, varied size or construction, improperly inflated, compact spare tyre*, etc.).
- The camera temperature gets too high.
- The parking brake is applied.
- When the lower bumper next to the fog light* is dirty.
- The vehicle is tilted due to a heavy load or suspension modifications.
- When tyre chains are installed.

* Not available on all models

Continued

☒ ACC Conditions and Limitations

The radar sensor for ACC is shared with the Collision Mitigation Braking System (CMBS).

➤ **Collision Mitigation Braking System (CMBS)*** P. 569

You can read about handling information for the camera equipped with this system.

➤ **Front Sensor Camera*** P. 501

Always keep the radar sensor cover clean.

Never use chemical solvents or polishing powder for cleaning the sensor cover. Clean it with water or a mild detergent.

Do not put a sticker on the radar sensor cover or replace the radar sensor cover.

If you need the radar sensor to be repaired, or removed, or the radar sensor cover is strongly impacted, turn off the system by pressing the **MAIN** button and take your vehicle to a dealer.

■ Detection limitations

- A vehicle suddenly crosses in front of you.
- The interval between your vehicle and the vehicle ahead of you is too short.
- A vehicle cuts in front of you at a slow speed, and it brakes suddenly.
- When you accelerate rapidly and approach the vehicle ahead of you at high speed.
- The vehicle ahead of you is a motorcycle, bicycle, mobility scooter, or other small vehicle.
- When there are animals in front of your vehicle.
- When you drive on a curved or winding or undulating road that makes it difficult for the sensor to properly detect a vehicle in front of you.
- The speed difference between your vehicle and a vehicle in front of you is significantly large.
- An oncoming vehicle suddenly comes in front of you.
- Your vehicle abruptly crosses over in front of an oncoming vehicle.
- When driving through a narrow iron bridge.
- When the vehicle ahead of you brakes suddenly.
- When the vehicle ahead of you has a unique shape.
- When your vehicle or the vehicle ahead of you is driving on one edge of the lane.

▣ ACC Conditions and Limitations

Have your vehicle checked by a dealer if you find any unusual behavior of the system (e.g., the warning message appears too frequently).

If the front of the vehicle is impacted in any of the following situations, the radar sensor may not work properly. Have your vehicle checked by a dealer:

- The vehicle mounted onto a bump, curb, chock, embankment, etc.
- You drive the vehicle where the water is deep.
- Your vehicle has a frontal collision.

■ To Adjust the Vehicle Speed

Increase or decrease the vehicle speed using the **RES/+** or **-/SET** buttons on the steering wheel.

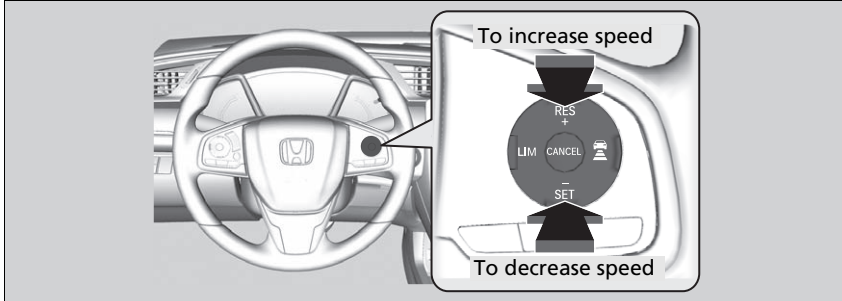

- Each time you press the button, the vehicle speed is increased or decreased by about 1 km/h accordingly.
- If you keep the button pressed, the vehicle speed increases or decreases by about 10 km/h accordingly.

☒ To Adjust the Vehicle Speed

If a vehicle detected ahead is going at a speed slower than your increased set speed, ACC may not accelerate your vehicle. This is to maintain the set interval between your vehicle and the vehicle ahead.

When you depress the accelerator pedal and then push and release the **-/SET** button, the current speed of the vehicle is set.

■ To Set or Change Following-interval

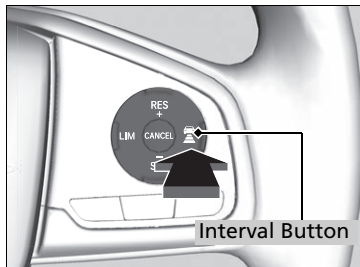

Press the  (interval) button to change ACC following-interval.





Each time you press the button, the following-interval (the interval behind a vehicle detected ahead of you) setting cycles through extra long, long, middle, and short following-intervals.

Determine the most appropriate following-interval setting based on your specific driving conditions. Be sure to adhere to any following-interval requirements set by local regulation.

▶▶ To Set or Change Following-interval

The driver must in all circumstances preserve a sufficient braking interval from the vehicle which precedes it and be aware that minimum intervals or times of spacing can be provided by the provisions of the Motorway Code locally applicable and that it is the driver's responsibility to respect those laws.

The higher your vehicle's following-speed is, the longer the short, middle, long or extra long following-interval becomes. See the following examples for your reference.

Following Interval		When the Set Speed is:	
		80 km/h	104 km/h
Short		25 meters 1.1 sec	31.5 meters 1.1 sec
Middle		33 meters 1.5 sec	43.4 meters 1.5 sec
Long		47 meters 2.1 sec	60.8 meters 2.1 sec
Extra Long		62 meters 2.8 sec	81.4 meters 2.8 sec

■ To Cancel

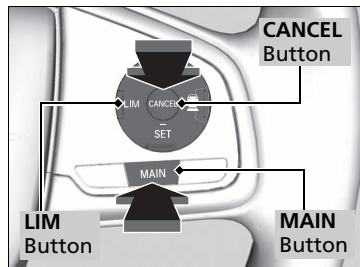

To cancel ACC, do any of the following:

- Press the **CANCEL** button.
- Press the **MAIN** button.
 - ▶ ACC indicator goes off.
- Press the **LIM** button.
- Depress the brake pedal.
- Depress the clutch pedal for five seconds or more.

▶▶ To Cancel

Resuming the prior set speed: After you have cancelled ACC, you can resume the prior set speed while it is still displayed. Press the **RES/+** button when driving at a speed of at least 30 km/h or more.

The set speed cannot be set or resumed when ACC has been turned off using the **MAIN** button. Press the **MAIN** button to activate the system, then set the desired speed.

■ Automatic cancellation

The beeper sounds and a message appears on the driver information interface when ACC is automatically cancelled. Any of these conditions may cause the ACC to be automatically cancelled.

- Bad weather (rain, fog, snow, etc.)
- When the radar sensor in the lower bumper next to the fog light* gets dirty.
- The vehicle ahead of you cannot be detected.
- An abnormal tyre condition is detected, or the tyres are skidding.
- Driving on a mountainous road, or driving off road for extended periods.
- Abrupt steering wheel movement.
- When the ABS, VSA or CMBS is activated.
- When the ABS or VSA system indicator comes on.
- When you manually apply the parking brake.
- When the detected vehicle within the ACC range is too close to your vehicle.
- The camera behind the rearview mirror, or the area around the camera, including the windscreen, gets dirty.
- When the Maximum Load Limit is exceeded.
- When passing through an enclosed space, such as tunnel.
- Ignoring shift down indication shown in the tachometer display will cancel the ACC after about 10 seconds.
- The engine speed goes into the tachometer's red zone.
- The engine speed goes to below 1,000 rpm.
- You shift into neutral temporarily when shifting into a higher or lower gear.

⌘ Automatic cancellation

Even though ACC has been automatically cancelled, you can still resume the prior set speed. Wait until the condition that caused ACC to cancel improves, then press the **-/SET** button.

■ Intelligent Adaptive Cruise Control Function

Provides an early prediction for a cut-in situation. The system detects that a vehicle running in the adjacent slower lane has an intention to cut in front of you and adjusts the speed of your vehicle in advance while ACC is activated.

■ How the system works

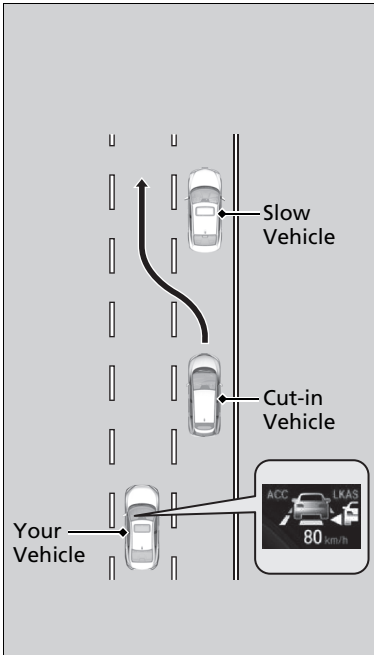

The radar sensor in the lower bumper next to the fog light* detects vehicles ahead of you including those in the adjacent lane, and the camera behind the rearview mirror detects the lane markings.

This system improves ACC's following/tracking property; it adjusts your vehicle speed in advance predicting a situation that a vehicle running in the adjacent slower lane catches up with a slower vehicle ahead of it and changes the lane to cut in front of you early.

When such a cut-in situation is predicted, your vehicle speed decreases a little. When detected, your vehicle speed decreases according to the vehicle cutting in front of you.

As the speed is adjusted by the system, the cut in vehicle icon appears on the driver information interface to indicate that the system is activated.

■ How the system activates

When a vehicle cuts in front of you is going faster than the vehicle ahead of it, and your vehicle is going faster than the cut-in vehicle (i.e., when you need to slow down), ACC predicts the cutting-in and adjust your vehicle speed.

The system activates when all the following conditions are met:

- When ACC is activated.
- When you are driving on a multi-lane road.
- When your vehicle speed is between about 80 km/h and about 180 km/h.
- The vehicle is on a straight or slightly curved road.
- The turn signals are off.
- The brake pedal is not depressed.
- When a vehicle cuts in from a slower lane.

■ Intelligent adaptive cruise control on and off

You can turn the system on and off using the driver information interface.

📖 **Customized Features*** P. 161, 359

📖 Intelligent Adaptive Cruise Control Function

When traffic changes from right hand side to left hand side, driving on a road where there is oncoming traffic for some distance automatically switches the lane to be detected from right to left.

Intelligent adaptive cruise control may not activate under the following conditions:

- When the speed difference between the cut-in vehicle and the vehicle ahead of it in the adjacent lane is small
- When the speed difference between the cut-in vehicle and your vehicle is small (i.e., when speed adjustment is not required)
- When a vehicle simply cuts in front of your vehicle with no vehicle ahead in the adjacent lane
- When a vehicle cuts in from a faster lane

* Not available on all models

Road Departure Mitigation System *

Alerts and helps to assist you when the system detects a possibility of your vehicle unintentionally crossing over detected lane markings.

How the System Works

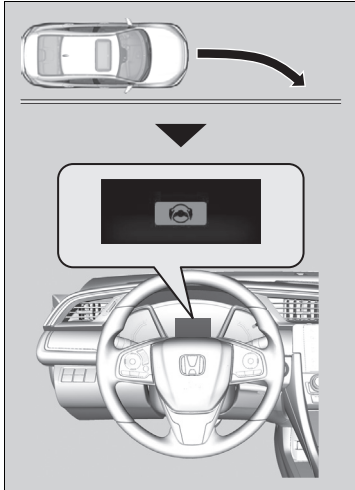

The front camera behind the rearview mirror monitors left and right lane markings (in white or yellow). If your vehicle is getting too close to detected lane markings without a turn signal activated, the system, in addition to a visual alert, applies steering torque and alerts you with rapid vibrations on the steering wheel, to help you remain within the detected lane.

▶ **Customized Features** P. 359

As a visual alert, the  message appears on the driver information interface.

If the system determines that its steering input is insufficient to keep your vehicle on the roadway, it may apply braking.

▶ Braking is applied only when the lane markings are solid continuous lines.

The system cancels assisting operations when you turn the steering wheel to avoid crossing over detected lane markings.

If the system operates several times without detecting driver response, the system beeps to alert you.

▶▶ Road Departure Mitigation System *

Important Safety Reminder

Like all assistance systems, the Road Departure Mitigation system has limitations. Over-reliance on the Road Departure Mitigation system may result in a collision. It is always your responsibility to keep the vehicle within your driving lane.

The Road Departure Mitigation system only alerts you when lane drift is detected without a turn signal in use. The Road Departure Mitigation system may not detect all lane markings or lane departures; accuracy will vary based on weather, speed and lane marker condition. It is always your responsibility to safely operate the vehicle and avoid collisions.

You can read about handling information for the camera equipped with this system.

▶ **Front Sensor Camera** * P. 501

The Road Departure Mitigation system may not work properly or may work improperly under the certain conditions:

▶ **Road Departure Mitigation Conditions and Limitations** P. 534

There are times when you may not notice Road Departure Mitigation functions due to your operation of the vehicle, or road surface conditions. If the  message appears repeatedly and you do not apply responsive actions, the beeper sounds and Road Departure Mitigation functions will be cancelled.

How the System Activates

The system becomes ready to start searching for lane markings when all the following conditions are met:

- The vehicle is travelling between about 72 and 185 km/h.
- The vehicle is on a straight or slightly curved road.
- The turn signals are off.
- The brake pedal is not depressed.
- The wipers are not in continuous operation.
- The system makes a determination that the driver is not actively accelerating, braking or steering.

Road Departure Mitigation On and Off

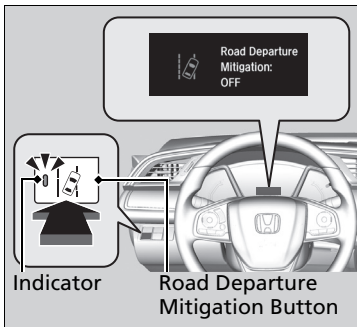

Press the Road Departure Mitigation button to turn the system on and off.

- ▶ The indicator in the button comes on and the message appears on the driver information interface when the system is on.

How the System Activates

The Road Departure Mitigation system may automatically shut off and the  indicator comes and stays on.

▶ Indicators P. 94

Road Departure Mitigation system function can be impacted when the vehicle is:

- Not driven within a traffic lane.
- Driven on the inside edge of a curve, or outside of a lane.
- Driven in a narrow lane.

Road Departure Mitigation On and Off

When you have selected **Warning Only** from the customized options using the audio/information screen, the system does not operate the steering wheel and braking.

■ Road Departure Mitigation Conditions and Limitations

The system may not properly detect lane markings and the position of your vehicle under certain conditions. Some examples of these conditions are listed below.

■ Environmental conditions

- Driving in bad weather (rain, fog, snow, etc.).
- Sudden changes between light and dark, such as an entrance or exit of a tunnel.
- There is little contrast between lane lines and the roadway surface.
- Driving into low sunlight (e.g., at dawn or dusk).
- Strong light is reflected onto the roadway.
- Driving in the shadows of trees, buildings, etc.
- Shadows of adjacent objects are parallel to lane markings.
- Roadway objects or structures are misinterpreted as lane markers.
- Reflections on the interior of the front windscreen.

■ Roadway conditions

- Driving on a snowy or wet roadway (obscured lane marking, vehicle tracks, reflected lights, road spray, high contrast).
- Driving on a road with temporary lane markings.
- Faint, multiple, or varied lane markings are visible on the roadway due to road repairs or old lane markings.
- The roadway has merging, split, or crossing lines (e.g., such as at an intersection or crosswalk).
- The lane markings are extremely narrow, wide, or changing.
- The vehicle in front of you is driving near the lane lines.
- The road is hilly or the vehicle is approaching the crest of a hill.
- Driving on rough or unpaved roads, or over bumpy surfaces.
- When objects on the road (curb, guard rail, pylons, etc.) are recognized as white lines (or yellow lines).
- When driving on roads with double lines.

■ Vehicle conditions

- Headlight lenses are dirty or the headlights are not properly adjusted.
- The outside of the windshield is streaked or blocked by dirt, mud, leaves, wet snow, etc.
- The inside of the windshield is fogged.
- The camera temperature gets too high.
- An abnormal tyre or wheel condition (wrong sized, varied size or construction, improperly inflated, compact spare tyre*, etc.).
- The vehicle is tilted due to a heavy load or suspension modifications.
- When tyre chains are installed.

* Not available on all models

Traffic Sign Recognition System *

Reminds you of road sign information, such as the current speed limit and that overtaking is prohibited, your vehicle has just passed through, showing it on the driver information interface.

How the System Works

When the camera located behind the rearview mirror captures traffic signs while driving, the system displays the ones that are recognized as designated for your vehicle. The sign icon will be displayed for a while, then until the vehicle reaches a predetermined time and distance.

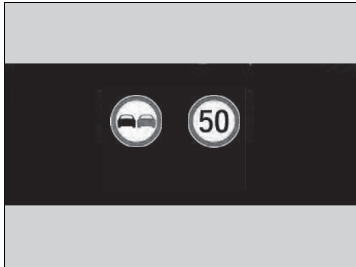

The sign icon also may switch to another one, or disappear when:

- The end of speed limit or other designated limit is detected.
- Your vehicle enters/exists motorway or highway.
- You make a turn with a turn signal to change direction at an intersection.

Traffic Sign Recognition System *

The system is designed to detect signs that follow the Vienna Convention standards. Not all signs may be displayed, but any signs posted on roadsides should not be ignored. The system does not work on the designated traffic signs of all the countries you travel, nor in all situations.

Do not rely too much on the system. Always drive at speeds appropriate for the road conditions.

Never apply a film or attach any objects to the windshield that could obstruct the camera's field of vision and cause the system to operate abnormally. Scratches, nicks, and other damage to the windshield within the camera's field of vision can cause the system to operate abnormally. If this occurs, we recommend that you replace the windshield with a genuine Honda replacement windshield. Making even minor repairs within the camera's field of vision or installing an aftermarket replacement windshield may also cause the system to operate abnormally. After replacing the windshield, have a dealer recalibrate the camera. Proper calibration of the camera is necessary for the system to operate properly.

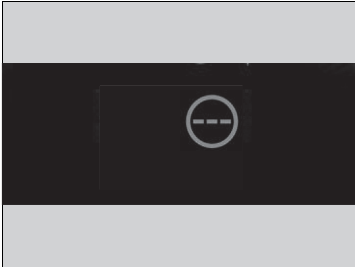

While driving, in addition to when there is no detected sign, you may also see the below screen when.





⊠ Traffic Sign Recognition System*

To help reduce the likelihood that high interior temperatures will cause the camera's sensing system to shut off, when parking, find a shady area or face the front of the vehicle away from the sun. If you use a reflective sun shade, do not allow it to cover the camera housing.

Covering the camera can concentrate heat on it.

If  appears, the Traffic Sign Recognition System does not work, and  will be displayed.

- Use the climate control system to cool down the interior and, if necessary, also use demister mode with the air flow directed towards the camera.
- Start driving the vehicle to lower the windscreen temperature, which cools down the area around the camera.

If  appears, the Traffic Sign Recognition System does not work, and  will be displayed.

- Park your vehicle in a safe place, and clean the windscreen. If the message does not disappear after you have cleaned the windscreen and driven for a while, have your vehicle checked by a dealer.

■ Traffic Sign Recognition System Conditions and Limitations

The Traffic Sign Recognition system may not be able to recognize the traffic sign in the following cases.

■ Vehicle conditions

- Headlight lenses are dirty or the headlights are not properly adjusted.
- The outside of the windscreen is blocked by dirt, mud, leaves, wet snow, etc.
- The inside of the windscreen is fogged.
- There are portions remaining to be wiped.
- An abnormal tyre or wheel condition (wrong sized, varied size or construction, improperly inflated, compact spare tyre*, etc.).
- The vehicle is tilted due to a heavy load or suspension modifications.

■ Environmental conditions

- Driving into low sunlight (e.g., at dawn or dusk).
- Strong light is reflected onto the roadway.
- Sudden changes between light and dark, such as an entrance or exit of a tunnel.
- When you drive in the shadows of trees, buildings, etc.
- Driving at night, in dark areas such as long tunnels.
- Driving in bad weather (rain, fog, snow, etc.).
- A vehicle in front of you is travelling flying up spray or snow.

▶▶ Traffic Sign Recognition System Conditions and Limitations

When the Traffic Sign Recognition System malfunctions,  appears on the driver information interface. If this message does not disappear, have your vehicle checked by a dealer.

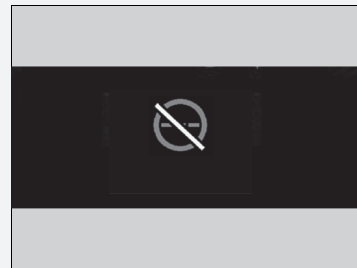

■ The position or the condition of the traffic sign

- A sign is hard to be found since it is in a complicated area.
- A sign is located far away from your vehicle.
- A sign is located where the beam of the headlight is hard to reach.
- A sign is on a corner or bend in the road.
- Faded or bent signs.
- Rotated or damaged signs.
- A sign is covered with mud, snow, or frost.
- A part of the sign is hidden by the trees, or the sign itself is hidden by a vehicle and others.
- Light (a streetlight) or a shadow is reflected on the surface of the sign.
- A sign is too bright or too dark (an electric sign).
- A sign of a small size.

■ Other conditions

- When you are driving at a high speed.

The Traffic Sign Recognition System may not operate correctly, such as displaying a sign that does not follow the actual regulation for the roadway or does not exist at all in the following cases.

- ▶ Regarding the speed limit sign, it may display higher or lower speed than the actual speed limit.
- There is a supplementary sign with further information such as weather, time, vehicle type, etc.
- Figures on the sign are hard to read (electric sign, numbers on the sign are blurred).
- A sign is in the vicinity of the lane you are driving even though it is not for the lane (speed limit sign situated at the junction between the side road and the main road, etc.).
- There are things that look similar to the colour or shape of the recognition object (similar sign, electric sign, signboard, structure, etc.).
- A lorry and others stuck with the sticker of the speed limit sign on the back are travelling in front of you.

■ Signs Displayed on the Driver Information Interface

Two traffic signs can be simultaneously displayed next to each other when detected. The speed limit sign icon is displayed on the right half of the screen. The overtaking prohibition sign icon appears on the left. Any additional sign that indicates speed limit based on weather (rain, snow, etc.) or specific period of time can appear on either side.

■ When main mode is selected

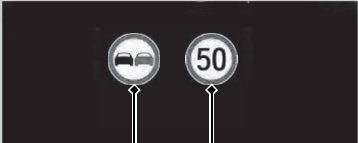

Overtaking Prohibition Sign*1

Speed Limit Sign



Additional Speed Limit Sign Based on Conditions*2

Speed Limit Sign

■ When main mode is not selected



Overtaking Prohibition Sign*1

Speed Limit Sign

Depending on situation, *1 can be replaced with *2, or *2 can appear on the right side.

■ **Selecting to display traffic signs when main mode is off**

You can continue displaying reduced-size traffic sign icon on the driver information interface even while the main mode is not selected.

➤ **Customized Features** P. 359

Lane Keeping Assist System (LKAS)*

Provides steering input to help keep the vehicle in the middle of a detected lane and provides audible and visual alerts if the vehicle is detected drifting out of its lane.

■ Steering input assist

The system applies torque to the steering to keep the vehicle between the left and right lane lines. The applied torque becomes stronger as the vehicle gets closer to either of the lane lines.



■ LKAS camera
Monitors the lane lines

■ Tactile and visual alerts
Rapid vibrations on the steering wheel and a warning display alert you that the vehicle is drifting out of a detected lane.

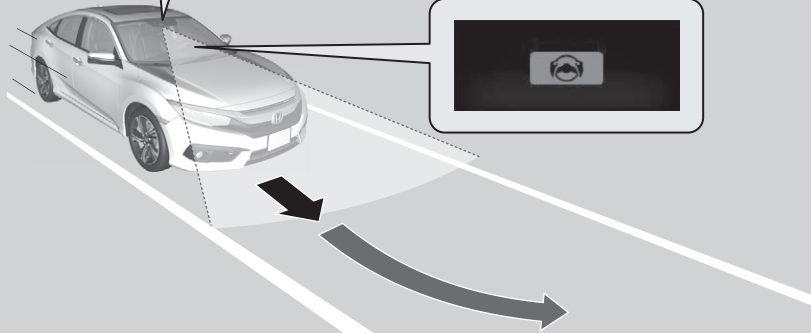

When you operate the turn signals to change lanes, the system is suspended, and resumes after the signals are off.

➡ If you make a lane change without operating the turn signals, the LKAS alerts activate, and torque is applied to the steering.

☒ Lane Keeping Assist System (LKAS)*

Important Safety Reminders

The LKAS is for your convenience only. It is not a substitute for your vehicle control. The system does not work if you take your hands off the steering wheel or fail to steer the vehicle.

☒ Driver Information Interface Warning and Information Messages* P. 126

Do not place objects on the instrument panel. Objects may reflect on the front windscreen and prevent correct detection of the traffic lanes.

The LKAS only alerts you when lane drift is detected without a turn signal in use. The LKAS may not detect all lane markings or lane departures; accuracy will vary based on weather, speed, and lane marker condition.

It is always your responsibility to safely operate the vehicle and avoid collisions.

The LKAS is convenient when it is used on motorway.

The LKAS may not work properly or may work improperly under the certain conditions:

☒ The LKAS Conditions and Limitations P. 548

You can read about handling information for the camera equipped with this system.

☒ Front Sensor Camera* P. 501

■ Lane Keep Support Function

Provides assistance to keep the vehicle in the centre of the lane. When the vehicle nears a white or yellow line, steering force of the electric power steering will become stronger.

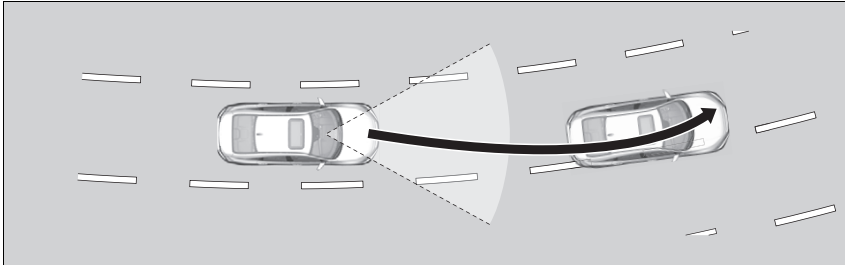

■ Lane Departure Warning Function

When the vehicle enters the warning area, the LKAS alerts you with slight steering wheel vibration as well as a warning display.

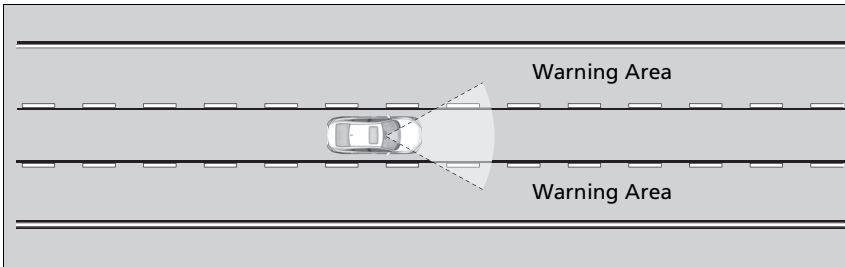

ⓘ Lane Keeping Assist System (LKAS)*

The LKAS may not function as designed while driving in frequent stop and go traffic, or on roads with sharp curves.

When it fails to detect lanes, the system will temporarily be cancelled. When lane is detected, system will recover automatically.

■ When the System can be Used

The system can be used when the following conditions are met.

- The lane in which you are driving has detectable lane markers on both sides, and your vehicle is in the centre of the lane.
- The vehicle speed is between 72 and 185 km/h.
- You are driving on a straight or slightly curved road.
- The turn signals are off.
- The brake pedal is not depressed.
- The wipers are not in continuous operation.

■ How to activate the system

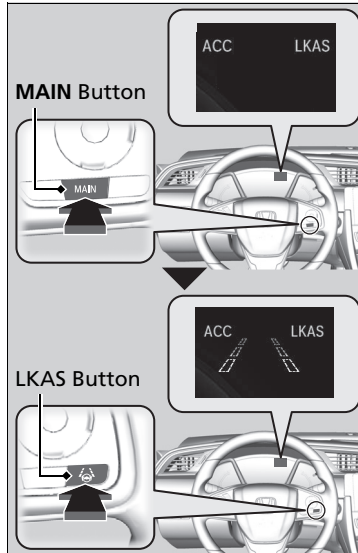

1. Press the **MAIN** button.
 - ▶ The LKAS is on in the driver information interface.
The system is ready to use.
2. Press the LKAS button.
 - ▶ Lane outlines appear on the driver information interface.
The system is activated.

⌘ When the System can be Used

If the vehicle drifts towards either the left or right lane line due to the system applying torque, turn off the LKAS and have your vehicle checked by a dealer.



3. Keep your vehicle near the centre of the lane while driving.
 - ▶ The dotted outer lines change to solid ones once the system starts operating after detecting the left and right lane markings.

▶▶ When the System can be Used

The LKAS temporarily deactivates when it fails to detect lane lines. When the system detects the lines again, it comes back on automatically.

▶▶ To cancel

Models with ACC with LSF

Pressing the **MAIN** button also turns ACC with LSF on and off.

Models with ACC

Pressing the **MAIN** button also turns ACC on and off.

To cancel

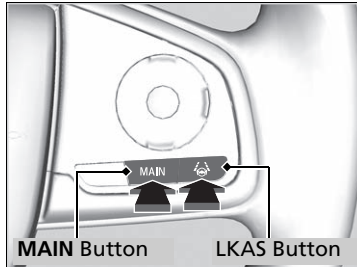

To cancel the LKAS:
Press the **MAIN** or LKAS button.

The LKAS is turned off every time you stop the engine, even if you turned it on the last time you drove the vehicle.



When the LKAS is suspended, the lane lines on the driver information interface change to contour lines, and the beeper sounds (if activated).

■ **The system operation is suspended if you:**

- Set the wipers to continuous operation.
 - ▶ Turning the wipers off resumes the LKAS.
- Decrease the vehicle speed to 64 km/h or less.
 - ▶ Increasing the vehicle speed to 72 km/h or more resumes the LKAS.
- Depress the brake pedal.
 - ▶ The LKAS resumes and starts detecting the lane lines again once you release the brake pedal.

Models with automatic intermittent wipers

- Set the wiper switch to **AUTO** to have the wipers operate continuously.
 - ▶ The LKAS resumes when the wipers stop or operate intermittently.

■ **The LKAS may automatically be suspended when:**

- The system fails to detect lane lines.
- The steering wheel is quickly turned.
- You fail to steer the vehicle.
- The vehicle runs on a curved road over the speed limit.
- Driving through a sharp curve.
- Driving at a speed in excess of approximately 185 km/h.

Once these conditions no longer exist, the LKAS automatically resumes.

■ **The LKAS may automatically be cancelled when:**

- The camera temperature gets extremely high or low.
- The camera behind the rearview mirror, or the area around the camera, including the windshield, gets dirty.
- The ABS or VSA system engages.

The beeper will sound if the LKAS is automatically cancelled.

■ **The LKAS Conditions and Limitations**

The system may not detect lane markings and therefore may not keep the vehicle in the middle of a lane under certain conditions, including the following:

■ **Environmental conditions**

- Driving in bad weather (rain, fog, snow, etc.).
- Sudden changes between light and dark, such as an entrance or exit of a tunnel.
- There is little contrast between lane lines and the roadway surface.
- Driving into low sunlight (e.g., at dawn or dusk).
- Strong light is reflected onto the roadway.
- Driving in the shadows of trees, buildings, etc.
- Shadows of adjacent objects are parallel to lane markings.
- Roadway objects or structures are misinterpreted as lane markers.
- Reflections on the interior of the front windshield.
- Driving at night or in a dark condition such as a tunnel.

■ Roadway conditions

- Driving on a snowy or wet roadway (obscured lane marking, vehicle tracks, reflected lights, road spray, high contrast).
- Driving on a road with temporary lane markings.
- Faint, multiple, or varied lane markings are visible on the roadway due to road repairs or old lane markings.
- The roadway has merging, split, or crossing lines (e.g., such as at an intersection or crosswalk).
- The lane markings are extremely narrow, wide, or changing.
- The vehicle in front of you is driving near the lane lines.
- The road is hilly or the vehicle is approaching the crest of a hill.
- Driving on rough or unpaved roads, or over bumpy surfaces.
- When objects on the road (curb, guard rail, pylons, etc.) are recognized as white lines (or yellow lines).
- When driving on roads with double lines.

■ Vehicle conditions

- Headlight lenses are dirty or the headlights are not properly adjusted.
- The outside of the windshield is streaked or blocked by dirt, mud, leaves, wet snow, etc.
- The inside of the windshield is fogged.
- The camera temperature gets too high.
- An abnormal tyre or wheel condition (wrong size, varied size or construction, improperly inflated, compact spare tyre, etc.).
- The vehicle is tilted due to a heavy load or suspension modifications.

Vehicle Stability Assist (VSA) System

VSA helps to stabilise the vehicle during cornering if the vehicle turns more or less than what was intended. It also assists in maintaining traction on slippery surfaces. It does so by regulating engine output and selectively applying the brakes.

■ VSA Operation

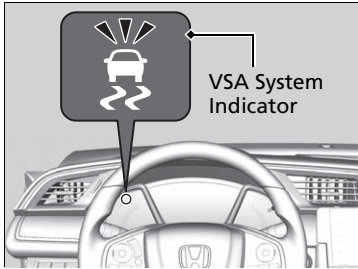

When VSA activates, you may notice that the engine does not respond to the accelerator. You may also notice some noise from the hydraulic system. You will also see the indicator blink.

▣ Vehicle Stability Assist (VSA) System

The VSA may not function properly if tyre types and sizes are mixed. Make sure to use the same size and type of tyre, and the air pressures are as specified.

When the VSA system indicator comes on and stays on while driving, there may be a problem with the system. While this may not interfere with normal driving, have your vehicle checked by a dealer immediately.

The VSA system indicator may come on after reconnecting the battery. Drive a short distance at more than 20 km/h. The indicator should go off. If it does not, have your vehicle checked by a dealer.

VSA cannot enhance stability in all driving situations and does not control the entire braking system. You still need to drive and corner at speeds appropriate for the conditions and always leave a sufficient margin of safety.

The main function of the VSA system is generally known as Electronic Stability Control (ESC). The system also includes a traction control function.

In certain unusual conditions when your vehicle gets stuck in shallow mud or fresh snow, it may be easier to free it with the VSA temporarily switched off.

VSA On and Off

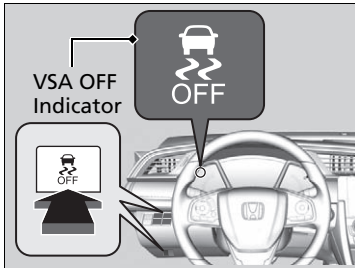

This button is on the driver side control panel. To partially disable VSA functionality/ features, press and hold it until you hear a beep.

Your vehicle will have normal braking and cornering ability, but traction control function will be less effective.

To restore VSA functionality/features, press the  (VSA OFF) button until you hear a beep.

VSA is turned on every time you start the engine, even if you turned it off the last time you drove the vehicle.

Vehicle Stability Assist (VSA) System

When the  button is pressed, the traction control function becomes less effective. This allows for the wheels to spin more freely at low speed. You should only attempt to free your vehicle with the VSA off if you are not able to free it when the VSA is on.

Immediately after freeing your vehicle, be sure to switch VSA on again. We do not recommend driving your vehicle with the VSA system switched off.

You may hear a motor sound coming from the engine compartment while system checks are being performed immediately after starting the engine or while driving. This is normal.

The VSA OFF indicator may come on after reconnecting the battery. Drive a short distance at more than 20 km/h. The indicator should go off. If it does not, have your vehicle checked by a dealer.

Agile Handling Assist

Lightly brakes selective wheels, as needed, when you turn the steering wheel, and helps support the vehicle's stability and performance during cornering.

ⓘ Agile Handling Assist

The agile handling assist cannot enhance stability in all driving situations. You still need to drive and corner at speeds appropriate for the conditions and always leave a sufficient margin of safety.

When the VSA system indicator comes on and stays on while driving, the agile handling assist does not activate.

You may hear a sound coming from the engine compartment while the agile handling assist is activated. This is normal.

Blind spot information (BSI) System*

Is designed to detect vehicles in specified alert zones adjacent to your vehicle, particularly in harder to see areas commonly known as “blind spots.”

When the system detects vehicles approaching from behind in adjacent lanes, the appropriate indicator comes on for a few seconds, providing assistance when you change lanes.

Blind spot information (BSI) System*

WARNING

Failure to visually confirm that it is safe to change lanes before doing so may result in a crash and serious injury or death. Do not rely only on the blind spot information system when changing lanes.

Always look in your mirrors, to either side of your vehicle, and behind you for other vehicles before changing lanes.

Important Safety Reminder

Like all assistance systems, BSI has limitations. Over reliance on BSI may result in a collision.

■ How the system works

- Radar sensors detect a vehicle in the alert zone when your vehicle is moving forward at 20 km/h or faster.

Alert zone range

- A: Approx. 0.5 m
- B: Approx. 3 m
- C: Approx. 3 m

Radar Sensors:
underneath the
rear bumper
corners

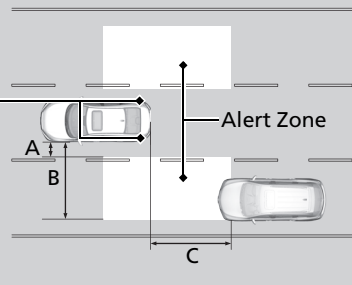

▶▶ Blind spot information (BSI) System*

The system is for your convenience only. Even if an object is within the alert zone, the following situations may occur.

- The BSI alert indicator may not come on due to obstruction (splashes, etc.) even without the **Blind Spot Information Not Available** driver information interface appearing.
- The BSI alert indicator may come on even with the message appearing.

The BSI alert indicator may not come on under the following conditions:

- A vehicle does not stay in the alert zone for more than two seconds.
- A vehicle is parked in a side lane.
- The speed difference between your vehicle and the vehicle you are passing is greater than 10 km/h.
- An object not detected by the radar sensors approaches or passes your vehicle.
- A vehicle running in the adjacent lane is a motorcycle or other small vehicle.

Continuously variable transmission models

The system does not operate when in **R**.

■ When the system detects a vehicle

BSI Alert Indicator: Located near the outside rearview mirror on both sides.

■ Comes on when

- A vehicle enters the alert zone from behind to overtake you with a speed difference of no more than 50 km/h from your vehicle.
- You pass a vehicle with a speed difference of no more than 20 km/h.

■ Blinks and the beeper sounds when

You move the turn signal lever in the direction of the detected vehicle. The beeper sounds three times.

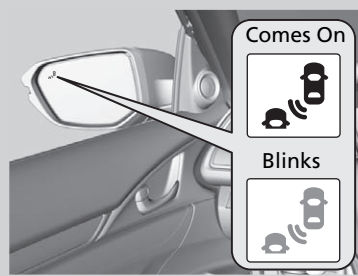

⊠ Blind spot information (BSI) System*

You can change the setting for BSI.

▶ **Customized Features** P. 359

Turn the system off when towing a trailer.

The system may not work properly for the following reasons:

- The added mass tilts the vehicle and changes the radar coverage.
- The trailer itself can be detected by the radar sensors, causing the BSI alert indicators to come on.

BSI may be adversely affected when:

- Objects (guard rails, poles, trees, etc.) are detected.
- An object that does not reflect radio waves well, such as a motorcycle, is in the alert zone.
- Driving on a curved road.
- A vehicle is moving from a far lane to the adjacent lane.
- The system picks up external electrical interference.
- The rear bumper or the sensors have been improperly repaired or the rear bumper has been deformed.
- The orientation of the sensors has been changed.
- In bad weather (Heavy rain, snow, and fog).
- Making a turn at an intersection.
- Driving on a bumpy road.
- Making a short turn that slightly tilts the vehicle.

For proper BSI operation:

- Always keep the rear bumper corner area clean.
- Do not cover the rear bumper corner area with labels or stickers of any kind.
- Take your vehicle to a dealer if you need the rear bumper corner area or the radar sensors to be repaired, or the rear bumper corner area is strongly impacted.

* Not available on all models

Except Egyptian models

Deflation Warning System

Instead of directly measuring the pressure in each tyre, the deflation warning system on this vehicle monitors and compares the rolling radius and rotational characteristics of each wheel and tyre while you are driving to determine if one or more tyres are significantly under-inflated. This will cause the low tyre pressure/deflation warning system indicator to come on and a message to appear on the driver information interface.

Deflation Warning System Calibration

You must start deflation warning system calibration every time you:

- Adjust the pressure in one or more tyres.
- Rotate the tyres.
- Replace one or more tyres.

Before calibrating the deflation warning system:

- Set the cold tyre pressure in all four tyres.

🔧 **Checking Tyres** P. 649

Make sure:

- The vehicle is at a complete stop.

Manual transmission models

- The electric parking brake is applied.

Continuously variable transmission models

- The shift lever is in **P**.

All models

- The ignition switch is in ON **II***1.

Deflation Warning System

The system does not monitor the tyres when driving at low speed.

Conditions such as low ambient temperature and altitude change directly affect tyre pressure and can trigger the low tyre pressure/deflation warning system indicator to come on.

Tyre pressure checked and inflated in:

- Warm weather can become under-inflated in colder weather.
- Cold weather can become over-inflated in warmer weather.

The Low Tyre Pressure/Deflation Warning System indicator will not come on as a result of over inflation.

The deflation warning system may not function properly if tyre type and size are mixed.

Make sure to use the same size and type of tyre.

🔧 **Checking and Maintaining Tyres** P. 649

The low tyre pressure/deflation warning system indicator may come on with a delay or may not come on at all when:

- You rapidly accelerate, decelerate, or turn the steering wheel.
- You drive on snowy or slippery roads.
- Snow chains are used.

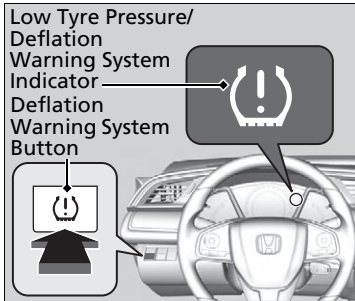

Models with information display

Press and hold the deflation warning system button until the low tyre pressure/deflation warning system indicator blinks twice, indicating the calibration process has begun.

- If the low tyre pressure/deflation warning system indicator does not blink, confirm the above conditions then press and hold the deflation warning system button again.
- The calibration process finishes automatically.

Deflation Warning System Calibration

The low tyre pressure/deflation warning system indicator may come on under the following conditions:

- There is a heavier and uneven load on the tyres, such as when towing a trailer, than the condition at calibration.
- Snow chains are used.
- The calibration process requires approximately 30 minutes of cumulative driving at speeds between 40–100 km/h.
- During this period, if the ignition is turned on and the vehicle is not moved within 45 seconds, you may notice the low tyre pressure indicator comes on briefly. This is normal and indicates that the calibration process is not yet complete.

If the snow chains are installed, remove them before calibrating the deflation warning system.

If the low tyre pressure/deflation warning system indicator comes on even when the properly inflated specified regular tyres are installed, have the vehicle checked by a dealer.

We recommend that the tyres be replaced with the same brand, model, and size as the originals. Ask a dealer for details.



The low tyre pressure/deflation warning system indicator may come on after re-connecting the battery. Drive a short distance at more than 20 km/h. The indicator should go off. If it does not, have your vehicle checked by a dealer.

* 1: Models with the keyless access system have an **ENGINE START/STOP** button instead of an ignition switch.



Models with Display Audio

You can calibrate the system from the customized feature on the audio/information screen.

1. Turn the ignition switch to ON *1.
2. Select .
3. Select **Settings**.
4. Select **Vehicle**.
5. Select **Deflation Warning System**.
6. Select **Cancel** or **Initialise**.

- If the **Failed** message appears, repeat steps 4-5.
- The calibration process finishes automatically.

* 1: Models with the keyless access system have an **ENGINE START/STOP** button instead of an ignition switch.

Models with LED headlights

Adjusting Headlight Distribution

Driving the right-hand type vehicle in right-hand traffic, or the left-hand type vehicle in left-hand traffic causes headlight glare to oncoming vehicles. You need to alter the headlight beam distribution using masking tape.

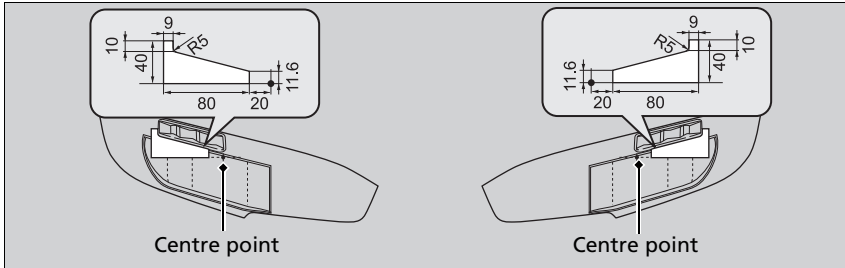

1. Prepare for two rectangular pieces of masking tape, measuring 40 mm wide and 80 mm long.
 - ▶ Use masking tape that can shut out light, such as seal type waterproof vinyl.
2. Affix the tape to the lens as shown.

Adjusting Headlight Distribution

Be careful not to adhere the tape to an incorrect location. If the headlight beam is distributed incorrectly, it may not comply with your country's legal requirements. Ask your dealer for details.

Brake System

■ Parking Brake

Use the electric parking brake to keep the vehicle stationary when parked. You can manually apply and release, or automatically release it.

■ Manual operations

Use the electric parking brake switch to apply or release the electric parking brake. Manually releasing the electric parking brake using the switch helps your vehicle start slowly and smoothly when facing down hill on steep hills.

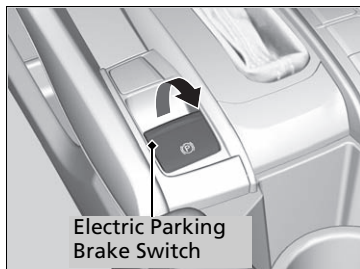

■ To apply manually

The electric parking brake can be applied any time the vehicle has battery, no matter which position the ignition switch*1 is in.

Pull the electric parking brake switch up gently and securely.

- ▶ The parking brake and brake system indicator comes on.



■ To release manually

The vehicle must be ON **II***1 in order to release the electric parking brake.

1. Depress the brake pedal.
2. Press the electric parking brake switch.

- ▶ The parking brake and brake system indicator goes off.

*1: Models with the keyless access system have an **ENGINE START/STOP** button instead of an ignition switch.

▣ Parking Brake

You may hear the electric parking brake system operating from the rear wheel area when you apply or release the electric parking brake. This is normal.

The brake pedal may slightly move due to the electric parking brake system operation when you apply or release the electric parking brake. This is normal.

You cannot apply or release the electric parking brake if the battery goes dead.

▣ **Jump Starting** P. 695

If you pull up and hold the electric parking brake switch while driving, the brakes on all four wheels are applied by the VSA system until the vehicle come to a stop. The electric parking brake then applies, and the switch should be released.

In the following situations, the electric parking brake automatically operates.

- When the vehicle stops with the automatic brake hold system activated for more than 10 minutes.
- When the driver's seat belt is unfastened while your vehicle is stopped and the brake hold system is applied.
- When the engine is turned off while the brake hold system is applied.
- When there is a problem with the brake hold system while brake hold is applied.

▣ Models with ACC with LSF

- When the vehicle is stops more than 10 minutes while ACC with LSF is activated.

■ To release automatically

Use the accelerator pedal to release the electric parking brake when you are starting the vehicle facing uphill, or in a traffic jam.

Continuously variable transmission models

Depressing the accelerator pedal releases the electric parking brake.

Manual transmission models

Depress the accelerator pedal while releasing the clutch pedal releases the electric parking brake.

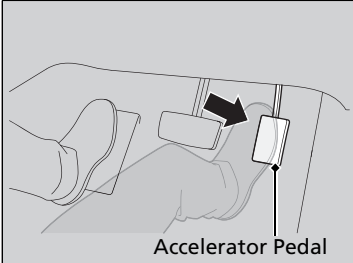

Continuously variable transmission models

Gently depress the accelerator pedal.

- ▶ The parking brake and brake system indicator goes off.

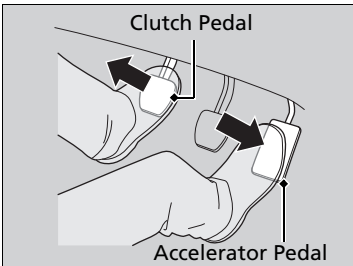

Manual transmission models

Gently depress the accelerator pedal and release the clutch pedal.

- ▶ The parking brake and brake system indicator goes off.

⊠ Parking Brake

- When the driver's seat belt is unfastened while your vehicle is stopped automatically by ACC with LSF.
- When the engine is turned off while ACC with LSF is activated.

Manual transmission models

- When there is a problem with the electric parking brake switch, after you turn the ignition switch to LOCK [0]*1.

If the electric parking brake cannot be released automatically, release it manually.

When the vehicle is travelling uphill, the accelerator pedal may need to be pressed farther to automatically release the electric parking brake.

The electric parking brake cannot be released automatically while the following indicators are on:

- Malfunction indicator lamp
- Transmission indicator

The electric parking brake may not be released automatically while the following indicators are on:

- Brake system indicator
- VSA system indicator
- **ABS** indicator
- Supplemental restraint system indicator

Manual transmission models

The clutch pedal is fully depressed before gently depress the accelerator pedal and release the clutch pedal.

The electric parking brake automatically releases as you depress the accelerator pedal when:

- You are wearing the driver's seat belt.
- The engine is running.

Continuously variable transmission models

- The transmission is not in **P** or **N**.

Manual transmission models

- The transmission is not in **N**.

Foot Brake

Your vehicle is equipped with disc brakes at all four wheels. A vacuum power assist helps to reduce the effort needed on the brake pedal. The brake assist system increases the stopping force when you depress the brake pedal hard in an emergency situation. The anti-lock brake system (ABS) helps you retain steering control when braking very hard.

➤ **Brake Assist System** P. 567

➤ **Anti-lock Brake System (ABS)** P. 566

Foot Brake

Check the brakes after driving through deep water, or if there is a buildup of road surface water. If necessary, dry the brakes by lightly depressing the pedal several times.

If you hear a continuous metallic friction sound when applying the brakes, the brake pads need to be replaced. Have your vehicle checked by a dealer.

Constantly using the brake pedal while going down a long hill builds up heat, which reduces the brake effectiveness. Apply engine braking by taking your foot off the accelerator pedal and downshifting to a lower gear/speed position. With manual transmission use a lower gear for greater engine braking.

Do not rest your foot on the brake pedal while driving, as it will lightly apply the brakes and cause them to lose effectiveness over time and reduce pad life. It will also confuse drivers behind you.

Automatic Brake Hold

Continuously variable transmission models

Keeps the brake applied after releasing the brake pedal until the accelerator pedal is pressed. You can use this system while the vehicle is temporarily stopped, like at traffic lights and in heavy traffic.

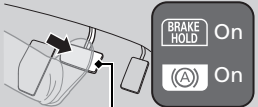
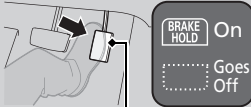
<p>■ Turning on the system</p>  <p>Automatic Brake Hold Button</p> <p>Fasten your seat belt properly, then start the engine. Press the automatic brake hold button.</p> <ul style="list-style-type: none"> The automatic brake hold system indicator comes on. The system is turned on. 	<p>■ Activating the system</p>  <p>Brake Pedal</p> <p>Depress the brake pedal to come to a complete stop. The shift lever must not be in P or R.</p> <ul style="list-style-type: none"> The automatic brake hold indicator comes on. Braking is kept for up to 10 minutes. Release the brake pedal after the automatic brake hold indicator comes on. 	<p>■ Canceling the system</p>  <p>Accelerator Pedal</p> <p>Depress the accelerator pedal while the shift lever is in a position other than P or N. The brake hold is disengaged and the vehicle starts to move.</p> <ul style="list-style-type: none"> The automatic brake hold indicator goes off. The system releases the brake automatically.
---	--	--

Automatic Brake Hold

⚠ WARNING

Activating the automatic brake hold system on steep hills or slippery roads may still allow the vehicle to move if you remove your foot from the brake pedal.

If a vehicle unexpectedly moves, it may cause a crash resulting in serious injury or death.

Never activate the automatic brake hold system or rely on it to keep a vehicle from moving when stopped on a steep hill or slippery roads.

⚠ WARNING

Using the automatic brake hold system to park the vehicle may result in the vehicle unexpectedly moving.

If a vehicle moves unexpectedly, it may cause a crash, resulting in serious injury or death.



Never leave the vehicle when braking is temporarily kept by automatic brake hold and always park the vehicle by putting the transmission in **P** and applying the parking brake.

Manual transmission models

Keeps the brake applied after releasing the brake pedal until you change a gear to a position other than **[N]** and:

- Release the clutch pedal on a level road or when facing downhill.
- Release the clutch pedal and depress the accelerator pedal when facing uphill.

You can use this system while the vehicle is temporarily stopped, like at traffic lights and in heavy traffic.

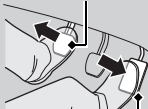
■ Turning on the system	■ Activating the system	■ Canceling the system
 <p>Automatic Brake Hold Button</p> <p>BRAKE HOLD On</p>	 <p>Brake Pedal</p> <p>BRAKE HOLD On (A) On</p>	<p>Clutch Pedal</p>  <p>Accelerator Pedal</p> <p>BRAKE HOLD On Goes Off</p>
<p>Fasten your seat belt properly, then start the engine. Press the automatic brake hold button.</p> <ul style="list-style-type: none"> • The automatic brake hold system indicator comes on. The system is turned on. 	<p>Depress the brake pedal to come to a complete stop.</p> <ul style="list-style-type: none"> • The automatic brake hold indicator comes on. Braking is kept for up to 10 minutes. • Release the brake pedal after the automatic brake hold indicator comes on. 	<p>Shift into one of the gears other than [N] and:</p> <ul style="list-style-type: none"> • Release the clutch pedal on a level road or when facing downhill. • Release the clutch pedal and depress the accelerator pedal when facing uphill. <p>The system is cancelled and the vehicle starts to move.</p> <ul style="list-style-type: none"> • The automatic brake hold indicator goes off. The system releases the brake automatically.

■ **The system automatically cancels when:**

- You engage the electric parking brake.

Continuously variable transmission models

- You depress the brake pedal and move the shift lever to **P** or **R**.

All models

Under the following conditions, the system automatically cancels, and the electric parking brake is applied:

- Braking is kept for more than 10 minutes.
- The driver's seat belt is unfastened.
- The engine is turned off.
- There is a problem with automatic brake hold system.
- The battery is disconnected.

Manual transmission models

- The engine stalls.

■ **Turning off the automatic brake hold system**

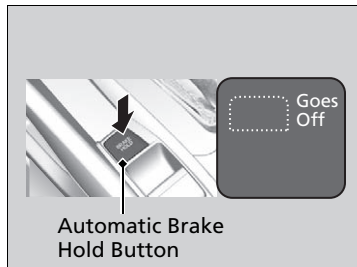

While the system is on, press the automatic brake hold button again.

- ▶ The automatic brake hold system indicator goes off.

If you want to turn off automatic brake hold while the system is in operation, press the automatic brake hold button with the brake pedal depressed.

⊞ **Automatic Brake Hold**

While the system is activated, you can turn off the engine or park the vehicle through the same procedure as you normally do.

➤ **When Stopped** P. 578

Whether the system is on, or the system is activated, the automatic brake hold turns off once the engine is off.

Manual transmission models

The system turns off if the engine stalls while automatic brake hold is active or the system is on.

⊞ **Turning on the system**

Make sure to turn off the automatic brake hold system before using an automated car wash.

You may hear an operating noise if the vehicle moves while the automatic brake hold system is in operation.

Anti-lock Brake System (ABS)

■ ABS

Helps to prevent the wheels from locking up, and helps you retain steering control by pumping the brakes rapidly, much faster than you.

The electronic brake distribution (EBD) system, which is part of the ABS, also balances the front-to-rear braking distribution according to vehicle loading.

You should never pump the brake pedal. Let the ABS work for you by always keeping firm, steady pressure on the brake pedal. This is sometimes referred to as “stomp and steer.”

■ ABS operation

The brake pedal may pulsate slightly when the ABS is working. Keep holding the pedal firmly down. On dry pavement, you will need to press on the brake pedal very hard before the ABS activates. However, you may feel the ABS activate immediately if you are trying to stop on snow or ice.

When the vehicle speed goes under 10 km/h, the ABS stops.

►► Anti-lock Brake System (ABS)

NOTICE

The ABS may not function correctly if you use a tyre of the wrong size or type.

If the **ABS** indicator comes on while driving, there may be a problem with the system. While normal braking will not be affected, there is a possibility that the ABS will not operating. Have your vehicle checked by a dealer immediately.

The ABS is not designed for the purpose of reducing the time or distance it takes for a vehicle to stop: It is designed to limit brake lockup which can lead to skidding and loss of steering control.

In the following cases, your vehicle may need more stopping distance than a vehicle without the ABS:

- When driving on rough road surfaces, including when driving on uneven surfaces, such as gravel or snow.
- When tyre chains are installed.

You may hear a motor sound coming from the engine compartment while system checks are being performed immediately after starting the engine or while driving. This is normal.

Brake Assist System

Is designed to assist the driver by generating greater braking force when you depress the brake pedal hard during emergency braking.

■ Brake assist system operation

Press the brake pedal firmly for more powerful braking.

When brake assist operates, the pedal may wiggle slightly and an operating noise may be heard. This is normal. Keep holding the brake pedal firmly down.

Emergency Stop Signal

Activates when you brake hard while driving at 60 km/h or above to alert drivers behind you about sudden braking by rapidly flashing hazard warning lights. This may help to alert drivers behind you to take appropriate means to avoid a possible collision with your vehicle.

■ When the system activates:

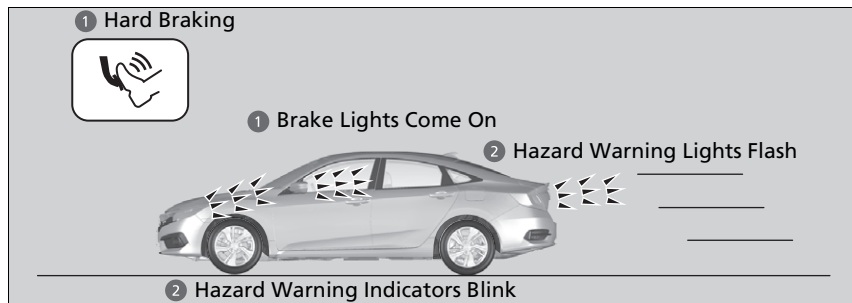

The hazard warning lights stop flashing when:

- You release the brake pedal.
- The ABS is deactivated.
- Your vehicle's decelerating speed becomes moderate.
- You press the hazard warning button.

» Emergency Stop Signal

The emergency stop signal is not a system that can prevent a possible rear-end collision caused by your hard braking. It flashes the hazard warning lights at the time you are braking hard. It is always recommended to avoid hard braking unless it is absolutely necessary.

The emergency stop signal does not activate with the hazard warning button pressed in.

If the ABS stops working for a certain period of the during braking, the emergency stop signal may not activate at all.

Collision Mitigation Braking System (CMBS)*

Can assist you when there is a possibility of your vehicle colliding with a vehicle or a pedestrian detected in front of yours. The CMBS is designed to alert you when a potential collision is determined, as well as to reduce your vehicle speed to help minimise collision severity when a collision is deemed unavoidable.

☒ Collision Mitigation Braking System (CMBS)*

Important Safety Reminder

The CMBS is designed to reduce the severity of an unavoidable collision. It does not prevent collision nor stop the vehicle automatically. It is still your responsibility to operate the brake pedal and steering wheel appropriately according to the driving conditions.

The CMBS may not activate or may not detect a vehicle in front of your vehicle under certain conditions:

☒ **CMBS Conditions and Limitations** P. 574

You can read about handling information for the camera equipped with this system.

☒ **Front Sensor Camera*** P. 501

Be careful not to hit the radar sensor.

■ How the system works

When to use

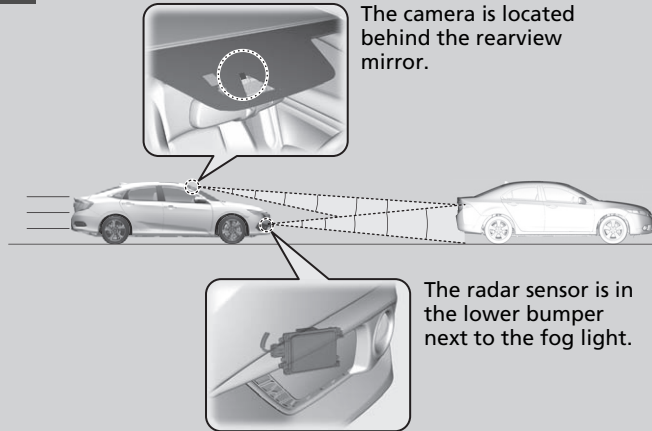

The camera is located behind the rearview mirror.

The radar sensor is in the lower bumper next to the fog light.

The system starts monitoring the roadway ahead when your vehicle speed is about 5 km/h and there is a vehicle in front of you.

The CMBS activates when:

- The speed difference between your vehicle and a vehicle or pedestrian detected in front of you becomes about 5 km/h and over with a chance of a collision.
- Your vehicle speed is about 100 km/h or less and the system determines there is a chance of a collision with:
 - Vehicles detected in front of you that are stationary, oncoming, or travelling in your same direction.
 - A pedestrian who is detected in front of you.
- Your vehicle speed is above 100 km/h, and the system determines there is a chance of a collision with a vehicle detected in front of you travelling in your same direction.

►► How the system works

When the CMBS activates, it may automatically apply the brake. It will be cancelled when your vehicle stops or a potential collision is not determined.

■ When the system activates

The system provides visual and audible alerts of a possible collision, and stops if the collision is avoided.

- ▶ Take appropriate action to prevent a collision (apply the brakes, change lanes, etc.)

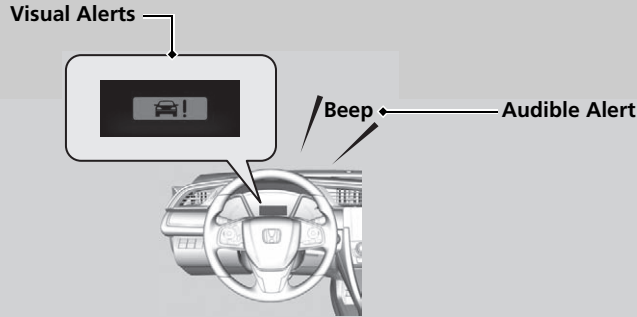

At system's earliest collision alert stage, you can change the distance (**Far/Normal/Near**) between vehicles at which alerts will come on through audio/information screen setting options.

- 📖 **List of customizable options** P. 375

📖 When the system activates

The camera in the CMBS is also designed to detect pedestrians.



However, this pedestrian detection feature may not activate or may not detect a pedestrian in front of your vehicle under certain conditions.

Refer to the ones indicating the pedestrian detection limitations from the list.

- 📖 **CMBS Conditions and Limitations** P. 574

■ Collision Alert Stages

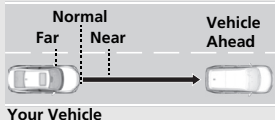
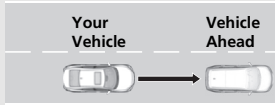
The system has three alert stages for a possible collision. However, depending on circumstances, the CMBS may not go through all of the stages before initiating the last stage.

Distance between vehicles	CMBS		
	The radar sensor detects a vehicle	Audible & Visual WARNINGS	Braking
Stage one 	There is a risk of a collision with the vehicle ahead of you.	When in Far , visual and audible alerts come on at a longer distance from a vehicle ahead than in Normal setting, and in Near , at a shorter distance than in Normal .	—
Stage two 	The risk of a collision has increased, time to respond is reduced.	Visual and audible alerts.	Lightly applied
Stage three 	The CMBS determines that a collision is unavoidable.		Forcefully applied

CMBS On and Off

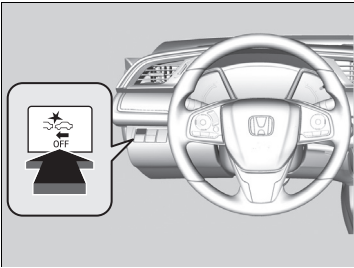

Press this button until the beeper sounds to switch the system on or off.

When the CMBS is off:

- The beeper sounds.
- The CMBS indicator in the instrument panel comes on.
- A message on the driver information interface reminds you that the system is off.

The CMBS is turned on every time you start the engine, even if you turned it off the last time you drove the vehicle.

Collision Mitigation Braking System (CMBS)*

The CMBS may automatically shut off, and the CMBS indicator will come and stay on under certain conditions:

▶ **CMBS Conditions and Limitations** P. 574

When the CMBS is activated, it will continue to operate even if the accelerator pedal is partially depressed. However, it will be cancelled if the accelerator pedal is deeply depressed.

The CMBS indicator may come on after re-connecting the battery.

Drive a short distance at more than 20 km/h. The indicator should go off. If it does not, have your vehicle checked by a dealer.

■ CMBS Conditions and Limitations

The system may automatically shut off and the CMBS indicator will come on under certain conditions. Some examples of these conditions are listed below. Other conditions may reduce some of the CMBS functions.

➤ **Front Sensor Camera*** P. 501

■ Environmental conditions

- Driving in bad weather (rain, fog, snow, etc.).
- Sudden changes in ambient light, such as an entrance or exit of a tunnel.
- There is little contrast between objects and the background.
- Driving into low sunlight (e.g., at dawn or dusk).
- Strong light is reflected onto the roadway.
- Driving in the shadows of trees, buildings, etc.
- Roadway objects or structures are misinterpreted as vehicles and pedestrians.
- Reflections on the interior of the windscreen.

■ Roadway conditions

- Driving on a snowy or wet roadway (obscured lane marking, vehicle tracks, reflected lights, road spray, high contrast on a snowy or wet roadway).
- Driving on curvy, winding, or undulating roads.
- The road is hilly or the vehicle is approaching the crest of a hill.

⊠ CMBS Conditions and Limitations

Do not put a sticker on the radar sensor cover or replace the radar sensor cover.

If you need the radar sensor to be repaired, or removed, or the radar sensor cover is strongly impacted, turn off the system by pressing the CMBS off button and take your vehicle to a dealer.

■ Vehicle conditions

- Headlight lenses are dirty or the headlights are not properly adjusted.
- The outside of the windscreen is blocked by dirt, mud, leaves, wet snow, etc.
- The inside of the windscreen is fogged.
- An abnormal tyre or wheel condition (wrong size, varied size or construction, improperly inflated, compact spare tyre, etc.).
- When tyre chains are installed.
- The vehicle is tilted due to a heavy load or suspension modifications.
- The camera temperature gets too high.
- Driving with the electric parking brake applied.
- When the radar sensor in the front grille gets dirty.

■ Detection limitations

- A vehicle or pedestrian suddenly crosses in front of you.
- The distance between your vehicle and the vehicle or pedestrian ahead of you is too short.
- A vehicle cuts in front of you at a slow speed, and it brakes suddenly.
- When you accelerate rapidly and approach the vehicle or pedestrian ahead of you at high speed.
- The vehicle ahead of you is a motorcycle, bicycle, mobility scooter or other small vehicle.
- When there are animals in front of your vehicle.
- When you drive on a curved, winding or undulating road that makes it difficult for the sensor to properly detect a vehicle in front of you.
- The speed difference between your vehicle and a vehicle or pedestrian in front of you is significantly large.
- An oncoming vehicle suddenly comes in front of you.
- Another vehicle suddenly comes in front of you at an intersection, etc.
- Your vehicle abruptly crosses over in front of an oncoming vehicle.
- When driving through a narrow iron bridge.
- When the lead vehicle suddenly slows down.

Limitations applicable to pedestrian detection only

- When there is a group of people in front of your vehicle walking together side by side.
- Surrounding conditions or belongings of the pedestrian alter the pedestrian's shape, preventing the system from recognizing that the person is a pedestrian.
- When the pedestrian is slouching or squatting.
- When the pedestrian is shorter than about 1 meter or taller than about 2 meters in height.
- When a pedestrian blends in with the background.
- When a pedestrian is bent over or squatting, or when their hands are raised or they are running.
- When several pedestrians are walking ahead in a group.
- When the camera cannot correctly identify that a pedestrian is present due to an unusual shape (holding luggage, body position, size).

■ **Automatic shutoff**

CMBS may automatically shut itself off and the CMBS indicator comes and stays on when:

- The temperature inside the system is high.
- You drive off-road or on a mountain road, or curved and winding road for an extended period.
- An abnormal tyre condition is detected (wrong tyre size, flat tyre, etc.).
- The camera behind the rearview mirror, or the area around the camera, including the windscreen, gets dirty.

Once the conditions that caused CMBS to shut off improve or are addressed (e.g., cleaning), the system comes back on.

■ With Little Chance of a Collision

The CMBS may activate even when you are aware of a vehicle ahead of you, or when there is no vehicle ahead. Some examples of this are:

■ When Passing

Your vehicle approaches another vehicle ahead of you and you change lanes to pass.

■ At an intersection

Your vehicle approaches or passes another vehicle that is making a left or right turn.

■ On a curve

When driving through curves, your vehicle comes to a point where an oncoming vehicle is right in front of you.

■ Through a low bridge at high speed

You drive under a low or narrow bridge at high speed.

■ Speed bumps, road work sites, train tracks, roadside objects, etc.

You drive over speed bumps, steel road plates, etc., or your vehicle approaches train tracks or roadside objects (such as a traffic sign and guard rail) on a curve or, when parking, stationary vehicles and walls.

⊠ Collision Mitigation Braking System (CMBS)*

For the CMBS to work properly:

Always keep the radar sensor cover clean.

Never use chemical solvents or polishing powder for cleaning the sensor cover. Clean it with water or a mild detergent.

Do not paint, or apply any coverings or paint to the radar sensor area. This can impact CMBS operation.

Have your vehicle checked by a dealer if you find any unusual behaviour of the system (e.g., the warning message appears too frequently).

If the front of the vehicle is impacted in any of the following situations, the radar sensor may not work properly. Have your vehicle checked by a dealer:

- The vehicle mounted onto a bump, curb, chock, embankment, etc.
- You drive the vehicle where the water is deep.
- Your vehicle has a frontal collision.

* Not available on all models

When Stopped

1. Depress the brake pedal firmly.
2. With the brake pedal depressed, slowly pull the electric parking brake switch all the way up.

Continuously variable transmission models

3. Move the shift lever from **D** to **P**.

Manual transmission models

3. Move the shift lever to **R** or **1**.

All models

4. Turn off the engine.
 - ▶ The parking brake and brake system indicator goes off in about 15 seconds.

Always confirm that the electric parking brake is set, in particular if you are parked on an incline.

▶▶ Parking Your Vehicle

Do not park your vehicle near flammable objects, such as dry grass, oil, or timber. Heat from the exhaust can cause a fire.

▶▶ When Stopped

Continuously variable transmission models

NOTICE

The following can damage the transmission:

- Depressing the accelerator and brake pedals simultaneously.
- Holding the vehicle in place when facing uphill by depressing the accelerator pedal.
- Moving the shift lever into **P** before the vehicle stops completely.

In extremely cold temperatures, the electric parking brake may freeze up if applied. If such temperatures are expected, do not apply the electric parking brake but, if parking on a slope, either turn the front wheels so they will contact the curb if the vehicle rolls down the slope or block the wheels to keep the vehicle from moving. If you do not take either precaution, the vehicle may roll unexpectedly, leading to a crash.

Parking Sensor System*

Models with 8 sensors

The corner and centre sensors monitor obstacles near your vehicle. The beeper and audio/information screen let you know the approximate distance between your vehicle and the obstacle.

■ The sensor location and range

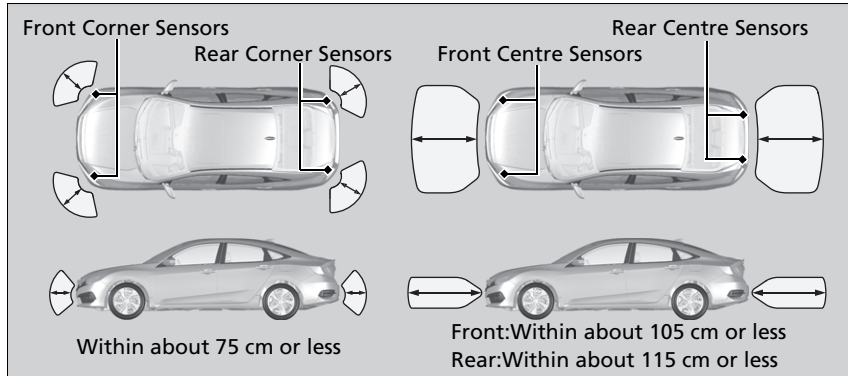

⊠ Parking Sensor System*

Even when the system is on, always confirm if there is no obstacle near your vehicle before parking.

The system may not work properly when:

- The sensors are covered with snow, ice, mud or dirt, etc.
- The vehicle is on uneven surface, such as grass, bumpy road, or a hill.
- The vehicle has been out in hot or cold weather.
- The system is affected by devices that emit ultrasonic waves.
- Driving in bad weather.

The system may not sense:

- Thin or low objects.
- Sonic-absorptive materials, such as snow, cotton, or sponge.
- Objects directly under the bumper.

Do not put any accessories on or around the sensors.

* Not available on all models

Continued

■ Parking sensor system on and off

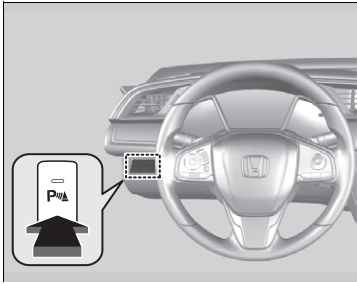

With the ignition switch in ON **[I]***1, press the parking sensor system button to turn on or off the system. The indicator in the button comes on when the system is on.

The rear centre and corner sensors start to detect an obstacle when the transmission is in **[R]**, and the vehicle speed is less than 8 km/h.

The front corner sensors start to detect an obstacle when the transmission is not in **[P]**, and the vehicle speed is less than 8 km/h.

Manual transmission models

You also need to release the parking brake.

*1: Models with the keyless access system have an **ENGINE START/STOP** button instead of an ignition switch.

■ When the distance between your vehicle and obstacles behind becomes shorter

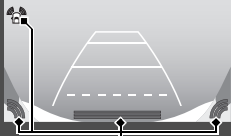
Length of the intermittent beep	Distance between the Bumper and Obstacle		Indicator	Audio/information screen
	Corner Sensors	Centre Sensors		
Moderate	—	Front: About 105-65 cm Rear: About 115-65 cm	Blinks in Yellow* ¹	 <p>Indicators light where the sensor detects an obstacle</p>
Short	About 75-50 cm	About 65-50 cm	Blinks in Amber	
Very short	About 50-40 cm	About 50-40 cm	Blinks in Amber	
Continuous	About 40 cm or less	About 40 cm or less	Blinks in Red	

*1: At this stage, only the centre sensors detect obstacles.

■ Turning off All Rear Sensors

1. Make sure that the parking sensor system is not activated. Turn the ignition switch to LOCK **[0]***1.
2. Press and hold the parking sensor system button, and turn the ignition switch to ON **[II]***1.
3. Keep pressing the button for 10 seconds. Release the button when the indicator in the button flashes.
4. Press the button again. The indicator in the button goes off.
 - ▶ The beeper sounds twice. The rear sensors are now turned off.

To turn the rear sensors on again, follow the above procedure. The beeper sounds three times when the rear sensors come back on.

▶▶ Turning off All Rear Sensors

When you set the gear position to **[R]**, the indicator in the parking sensor system button blinks as a reminder that the rear sensors have been turned off.

*1: Models with the keyless access system have an **ENGINE START/STOP** button instead of an ignition switch.

Parking Sensor System*

Models with 4 sensors

The rear corner and centre sensors monitor obstacles behind your vehicle, and the beeper and information display*/driver information interface* let you know the approximate distance between your vehicle and the obstacle.

■ The sensor location and range

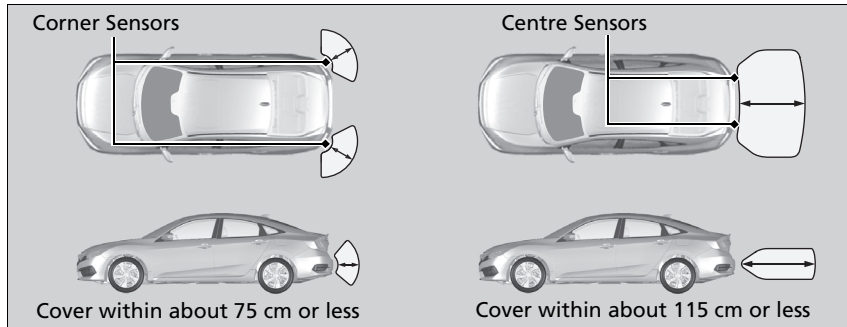

■ Parking sensor system on and off

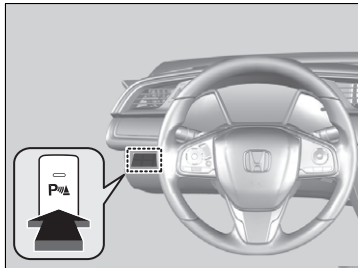

With the ignition switch in ON **II***1, press the parking sensor system button to turn on or off the system. The indicator in the button comes on when the system is on.

The system activates when the shift lever is in **R**.

Manual transmission models

You also need to release the electric parking brake.

* Not available on all models

Continued

⊠ Parking Sensor System*

Even the system is on, always confirm if there is no obstacle near your vehicle before parking.

The system may not work properly when:

- The sensors are covered with snow, ice, mud or dirt.
- The vehicle is on uneven surface, such as grass, bumps, or a hill.
- The vehicle has been out in hot or cold weather.
- The system is affected by devices that emit ultrasonic waves.
- Driving in bad weather.

The system may not sense:

- Thin or low objects.
- Sonic-absorptive materials, such as snow, cotton, or sponge.
- Objects directly under the bumper.

Do not put any accessories on or around the sensors.

⊠ Parking sensor system on and off

When you turn the ignition switch to ON **II***1, the system will be in the previously selected condition.

*1: Models with the keyless access system have an **ENGINE START/STOP** button instead of an ignition switch.

■ When the distance between your vehicle and obstacles behind becomes shorter

Length of the intermittent beep	Distance between the bumper and obstacle		Indicator	Audio/information screen
	Corner sensors	Centre sensors		
Moderate	—	About 115-65 cm	Blinks in yellow*1	 <p>Indicators light where the sensor detects an obstacle.</p>
Short	About 75-50 cm	About 65-50 cm	Blinks in amber	
Very short	About 50-40 cm	About 50-40 cm		
Continuous	About 40 cm or less	About 40 cm or less	Blinks in red	

*1: At this stage, only the centre sensors detect obstacles.

Cross Traffic Monitor*

Monitors the rear corner areas using the radar sensors when reversing, and alerts you if a vehicle approaching from a rear corner is detected.

The system is convenient especially when you are getting out of a parking space backwards.

⚠ Cross Traffic Monitor*

⚠ CAUTION

Cross Traffic Monitor cannot detect all approaching vehicles and may not detect an approaching vehicle at all.

Failure to visually confirm that it is safe to back up the vehicle before doing so may result in a collision.

Do not solely rely on the system when reversing; always also use your mirrors, and look behind and to the sides of your vehicle before reversing.

* Not available on all models

Continued

■ How the System Works

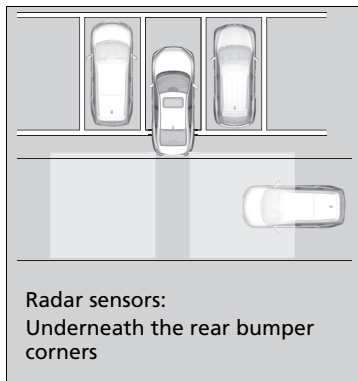

The system activates when:

- The power mode is in ON.
- The Cross Traffic Monitor system is turned on.
 - ▣ **Cross Traffic Monitor On and Off** P. 588
- The transmission is in **R**.
- Your vehicle is moving at 5 km/h or lower.

When a vehicle is detected approaching from a rear corner, Cross Traffic Monitor alerts you with a buzzer and a displayed warning.

The system will not detect a vehicle that approaches from directly behind your vehicle, nor will it provide alerts about a detected vehicle when it moves directly behind your vehicle.

The system does not detect or provide alerts for a vehicle that is moving away from your vehicle, and it may not detect or alert for pedestrians, bicycles, or stationary objects.

▣ Cross Traffic Monitor*

Cross traffic monitor may not detect or may delay detecting an approaching vehicle, or may alert detection without an approaching vehicle under the following conditions:

- An obstacle, such as another vehicle and a wall, near your vehicle's rear bumper, is blocking the radar sensor's scope.
- Your vehicle is moving at the speed of about 5 km/h or higher.
- A vehicle is approaching at the speed other than between about 10 and 25 km/h.
- The system picks up external interference such as other radar sensors from another vehicle or strong radio wave transmitted from a facility nearby.
- Either corner of the rear bumper is covered with snow, ice, mud or dirt.
- When there is bad weather.
- Your vehicle is on an incline.
- Your vehicle is tilted due to a heavy load in the rear.
- Your vehicle is reversing towards a wall, a pole, a vehicle, and so on.
- The rear bumper or the sensors have been improperly repaired or the rear bumper has been deformed. Have your vehicle checked by a dealer.

For proper operation, always keep the rear bumper corner area clean. Do not cover the rear bumper corner area with labels or stickers of any kind.

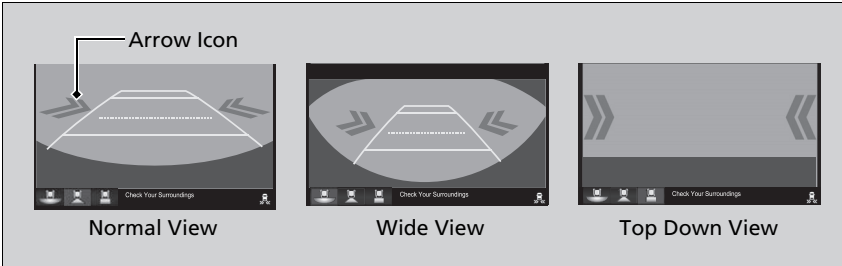

The parking sensor system's alerting buzzer overrides the Cross Traffic Monitor buzzer when the sensors are detecting obstacles at the closest range.

When the System Detects a Vehicle



An arrow icon appears on the side a vehicle is approaching on the audio/information screen.

When the System Detects a Vehicle

If the  on the lower right changes to  in amber when the transmission is in **R**, mud snow or ice and other debris may have accumulated in the vicinity of the sensor. The system is temporarily cancelled. Check the bumper corners for any obstructions, and thoroughly clean the area if necessary.

If the  comes on when the transmission is in **R**, there may be a problem with the Cross Traffic Monitor system. Do not use the system and have your vehicle checked by a dealer.

If the display remains the same with the gear position in **R**, there may be a problem with the rear camera system and the Cross Traffic Monitor system. Do not use the system and have your vehicle checked by a dealer.

■ Cross Traffic Monitor On and Off

Tap to turn the system on and off. The indicator (green) comes on with the system on.

You can also switch on and off the system using the audio/information screen.

▶ **Customized Features** P. 359

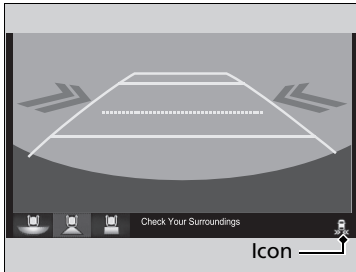

About Your Multi-View Rear Camera

The audio/information screen can display your vehicle's rear view.

The display automatically changes to a rear view when the shift lever is moved to **R**.

Multi-View Rear Camera Display Area

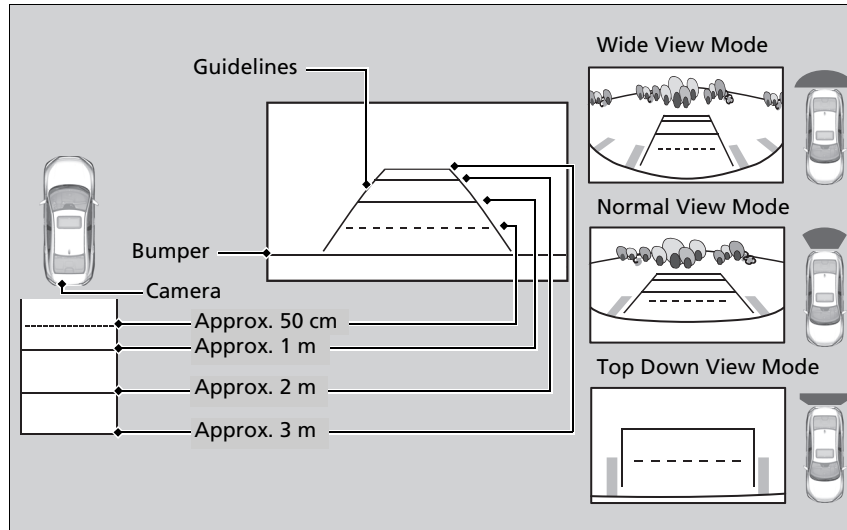

About Your Multi-View Rear Camera

The rear camera view is restricted. You cannot see the corner ends of the bumper or what is underneath the bumper. Its unique lens also makes objects appear closer or farther than they actually are.

Visually confirm that it is safe to drive before reversing. Certain conditions (such as weather, lighting, and high temperatures) may also restrict the rear view. Do not rely on the rearview display which does not give you all information about conditions at the back of your vehicle.

If the camera lens is covered with dirt or moisture, use a soft, moist cloth to keep the lens clean and free of debris.

You can change the **Fixed Guideline** and **Dynamic Guideline*** settings.

➤ **Customized Features** P. 359

Fixed Guideline

On: Guidelines appear when you shift into **R**.

Off: Guidelines do not appear.

Dynamic Guidelines*

On: Guidelines move according to the steering wheel direction.

Off: Guidelines do not move.

* Not available on all models

You can view three different camera angles on the rearview display.

Models with colour audio system

Press the selector knob to switch the angle.

Models with Display Audio

Touch the appropriate icon to switch the angle.



: Wide view



: Normal view



: Top down view

- If the last used viewing mode was Wide or Normal, the same mode is selected the next time you shift into **R**.
- If Top View was last used before you turned off the engine, Wide mode is selected next time you set the power mode to ON and shift to **R**.
- If Top View was last used more than 10 seconds after you shift from **R**, Wide mode is selected the next time you shift to **R**.

*1: Models with the keyless access system have an **ENGINE START/STOP** button instead of an ignition switch.

Fuel Information

■ Fuel recommendation

1.6 L engine models for Middle Eastern except Israeli and Turkish

Unleaded petrol, research octane number 91 or higher

Use of lower octane petrol can cause a persistent, heavy metallic knocking noise that can lead to engine damage.

1.6 L engine models for Israeli, Turkish, and except Middle Eastern

Unleaded premium petrol, research octane number 95 or higher

Your vehicle is designed to operate on premium unleaded petrol with a research octane of 95 or higher.

If this octane grade is unavailable, regular Unleaded petrol with a research octane of 91 or higher may be used temporarily.

The use of regular unleaded petrol can cause metallic knocking noises in the engine and will result in decreased engine performance. The long-term use of regular-grade petrol can lead to engine damage.

1.5 L engine models

Unleaded premium petrol/gasohol up to E10 (90% petrol and 10% ethanol), research octane number 95 or higher

Your vehicle is designed to operate on premium unleaded petrol with a research octane of 95 or higher.

If this octane grade is unavailable, regular Unleaded petrol with a research octane of 91 or higher may be used temporarily.

The use of regular unleaded petrol can cause metallic knocking noises in the engine and will result in decreased engine performance. The long-term use of regular-grade petrol can lead to engine damage.

■ Fuel tank capacity: 46.9 litres

⌘ Fuel Information

NOTICE

Use of petrol that contains lead presents the following risks:

- Damage to the exhaust system including the catalytic converter
- Damage to the engine and fuel system
- Detrimental effects on the engine and other systems

Oxygenated Fuels

Oxygenated fuels are blended with petrol and ethanol or other compounds. Your vehicle is also designed to operate on oxygenated fuels containing up to 10% ethanol by volume and up to 22% ETBE by volume, based on the EN 228 standards. For more information, ask your dealer.

How to Refuel

Your fuel tank is not equipped with a fuel filler cap. You can insert the filler nozzle directly into the filler neck. The tank seals itself again when you pull out the filler nozzle.



1. Stop your vehicle with the service station pump on the left side of the vehicle in the rear.
2. Turn off the engine.
3. Unlock the driver's door using the master door lock switch or lock tab.
 - ▶ The fuel fill door on the outer side of the vehicle will unlock.
4. Press on the edge of the fuel fill door to make it pop up slightly.

How to Refuel

⚠ WARNING

Petrol is highly flammable and explosive. You can be burned or seriously injured when handling fuel.

- Stop the engine, and keep heat, sparks, and flame away.
- Handle fuel only outdoors.
- Wipe up spills immediately.

The fuel filler opening is designed to accept only service station filler nozzles for refueling. Use of smaller diameter tubes (e.g., those used to siphon fuel for other uses) or other non-service station devices can damage the area in and around the filler opening.

The filler nozzle automatically stops to leave space in the fuel tank so that fuel does not overflow as a result of changes in air temperature.

Use the lock tab or the master door lock switch to unlock the fuel fill door.

The vehicle doors and fuel fill door automatically relock if the remote unlock function is used. This can be deactivated by briefly opening then closing the driver's door.

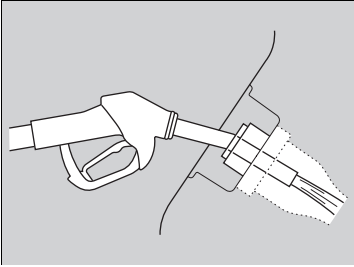

5. Place the end of the filler nozzle on the lower part of filler opening, then insert it slowly and fully.
 - ▶ Make sure that the end of the filler nozzle goes down along with the filler pipe.
 - ▶ Keep the filler nozzle level.
 - ▶ When the tank is full, the filler nozzle will click off automatically.
 - ▶ After filling, wait about five seconds before removing the filler nozzle.
6. Shut the fuel fill door by hand.

▣ How to Refuel

The fuel fill door and its latching mechanism can be permanently damaged if the fuel fill door is forced closed when the driver's door is locked.

Do not continue to add fuel after the nozzle has automatically stopped. Additional fuel can exceed the full tank capacity.

If you have to refuel your vehicle from a portable container, use the funnel provided with your vehicle.

▣ **Refueling From a Portable Fuel Container**
P. 721

Improving Fuel Economy and Reducing CO₂ Emissions

Achieving fuel economy and reducing CO₂ emissions is dependent on several factors, including driving conditions, load weight, idling time, driving habits, and vehicle condition. Depending on these and other factors, you may not achieve the rated fuel economy of this vehicle.

Maintenance and Fuel Economy

You can optimize your fuel economy with proper maintenance of your vehicle. Follow the maintenance schedule and, if necessary, consult your warranty booklet. On vehicles without service reminder system, follow the Maintenance schedule.

📄 Maintenance Schedule P. 610

- Use engine oil with the viscosity recommended by the ACEA or API Certification Seal.
- Maintain the specified tyre pressure.
- Do not load the vehicle with excess luggage.
- Keep your vehicle clean. A buildup of snow or mud on your vehicle's underside adds weight and increases wind resistance.

📄 Improving Fuel Economy and Reducing CO₂ Emissions

Direct calculation is the recommended method to determine actual fuel consumed while driving.

100	×	Litres of fuel	÷	Kilometres driven	=	L per 100 km
Kilometres driven	÷	Litres of fuel	=	Kilometres per Litre		

GCC country models

You can improve the mileage and reduce the CO₂ emissions of your vehicle by following these tips:

- Operate your vehicle correctly.
- Regularly maintain your vehicle.
- Maintain proper tyre pressure.
- Avoid carrying excessive loads.
- Adopt efficient driving techniques, such as driving at lower speeds, reducing idling time, and avoiding aggressive driving.

Handling Precautions

The turbocharger is a high-precision device to obtain greater horsepower by delivering a large volume of compressed air into the engine using a turbine driven by the engine's exhaust gas pressure.

- When the engine is cold just after starting, avoid revving the engine or sudden acceleration.
- Always replace the engine oil and engine oil filter according to the Oil Monitor system. The turbine rotates at very high speeds over 100,000 rpm and its temperature reaches over 700°C. It is lubricated and cooled by engine oil. If you fail to replace the engine oil and filter at the scheduled distance or interval, deteriorated engine oil may cause failure such as sticking and abnormal noise of the turbine bearing.

*1: Middle Eastern except Israeli and Turkish models

*2: Israeli, Turkish, and except Middle Eastern models

* Not available on all models

☒ Turbo Engine Vehicle*

The scheduled maintenance intervals for replacing the filter is indicated on the driver information interface. Follow the information of when to replace them.

☒ **Service Reminder System*** P. 601

☒ **Oil Monitor System*** P. 606

The temperature gauge pointer is at the **[H]** mark*¹ or upper level*² when you restart the engine after driving under high load conditions such as at high speed or in hilly terrain. This is normal. The gauge goes down after you idle or drive the vehicle for about one minute.

Maintenance

This chapter discusses basic maintenance.



Before Performing Maintenance

Inspection and Maintenance	598
Safety When Performing Maintenance	599
Parts and Fluids Used in Maintenance	
Service	600
About Your Maintenance Service	600
Service Reminder System*	601
Oil Monitor System*	606
Maintenance Schedule	610
Maintenance Under the Bonnet	
Maintenance Items Under the Bonnet ..	617
Opening the Bonnet	619
Recommended Engine Oil	621

Oil Check	624
Adding Engine Oil	626
Engine Coolant	627
Transmission Fluid	630
Brake/Clutch* Fluid	631
Refilling Window Washer Fluid	632
Fuel Filter	633
Replacing Light Bulbs	634
Checking and Maintaining Wiper	
Blades	646
Checking and Maintaining Tyres	
Checking Tyres	649
Wear Indicators	650

Tyre Service Life	650
Tyre and Wheel Replacement	651
Tyre Rotation	652
Snow Traction Devices	654
Battery	656
Remote Transmitter Care	
Replacing the Button Battery	661
Climate Control System Maintenance	663
Cleaning	
Interior Care	666
Exterior Care	668
Accessories and Modifications	671

* Not available on all models

Inspection and Maintenance

For your safety, perform all listed inspections and maintenance to keep your vehicle in good condition. If you become aware of any abnormality (noise, smell, insufficient brake fluid, oil residue on the ground, etc.), have your vehicle inspected by a dealer. Refer to the Service Book that came with your vehicle/maintenance schedule in this owner's manual for detailed maintenance and inspection information.

➤ **Maintenance Schedule** P. 610

Types of Inspection and Maintenance

■ Daily inspections

Perform inspections before long distance trips, when washing the vehicle, or when refueling.

■ Periodic inspections

- Check the brake fluid level monthly.
 - **Brake/Clutch* Fluid** P. 631
- Check the tyre pressure monthly. Examine the tread for wear and foreign objects.
 - **Checking and Maintaining Tyres** P. 649
- Check the operation of the exterior lights monthly.
 - **Replacing Light Bulbs** P. 634
- Check the condition of the wiper blades at least every six months.
 - **Checking and Maintaining Wiper Blades** P. 646

Safety When Performing Maintenance

Some of the most important safety precautions are given here. However, we cannot warn you of every conceivable hazard that can arise in performing maintenance. Only you can decide whether you should perform a given task.

Maintenance Safety

- To reduce the possibility of fire or explosion, keep cigarettes, sparks, and flames away from the battery and all fuel related parts.
- Never leave rags, towels, or other flammable objects under the bonnet.
 - ▶ Heat from the engine and exhaust can ignite them, causing a fire.
- To clean parts, use a commercially available degreaser or parts cleaner, not petrol.
- Wear eye protection and protective clothing when working with the battery or compressed air.
- Engine exhaust contains carbon monoxide, which is poisonous and can kill you.
 - ▶ Only operate the engine if there is sufficient ventilation.

Vehicle Safety

- The vehicle must be in a stationary condition.
 - ▶ Make sure your vehicle is parked on level ground, the parking brake is set, and the engine is off.
- Be aware that hot parts can burn you.
 - ▶ Make sure to let the engine and exhaust system cool thoroughly before touching vehicle parts.
- Be aware that moving parts can injure you.
 - ▶ Do not start the engine unless instructed, and keep your hands and limbs away from moving parts.

Models with Auto Idle Stop

- ▶ Do not open the bonnet while the Auto Idle Stop function is activated.

⚠ Safety When Performing Maintenance

⚠ WARNING

Improperly maintaining this vehicle or failing to correct a problem before driving can cause a crash in which you can be seriously hurt or killed.

Always follow the inspection and maintenance recommendations and schedules in this owner's manual/Service Book.

⚠ WARNING

Failure to properly follow maintenance instructions and precautions can cause you to be seriously hurt or killed.

Always follow the procedures and precautions in this owner's manual.

Parts and Fluids Used in Maintenance Service

The use of Honda genuine parts and fluids is recommended when maintaining and servicing your vehicle. Honda genuine parts are manufactured according to the same high quality standards used in Honda vehicles.

Models with service reminder system

About Your Maintenance Service

If the service reminder system is available in your vehicle, you are informed by the driver information interface when your vehicle's maintenance services are due. Refer to the service book that came with your vehicle for an explanation of the service item codes that appear on the display.

➤ **Service Reminder System** * P. 601

If the service reminder system is not available, follow the maintenance schedules in the service book that came with your vehicle.

If your vehicle is without the service book, follow the maintenance schedule in this owner's manual.

➤ **Maintenance Schedule** P. 610

You are informed by the maintenance required indicator when your vehicle's maintenance services are due.

➤ **Service Reminder System** * P. 601

▶▶ About Your Maintenance Service

If you are planning to take your vehicle outside the service reminder system applied countries, consult a dealer for how to record your service reminder information and schedule your maintenance service under the conditions of that country.

Service Reminder System*

Provides information of which service items are to be performed. Service items are represented by a code and icon. The system tells you when to take your vehicle to a dealer by days remaining.

When the next maintenance service timing is near, coming or passed, a warning message* will also appear on the driver information interface* every time you turn the ignition switch to ON *1.

*1: Models with the keyless access system have an **ENGINE START/STOP** button instead of an ignition switch.

* Not available on all models

Continued

Service Reminder System*

You can choose to have a corresponding warning message displayed with the warning icon on the driver information interface.

The maintenance schedule may not display correct information if you disconnect or remove the battery for an extended period. If this occurs, see a dealer.

■ Displaying the Service Reminder Information

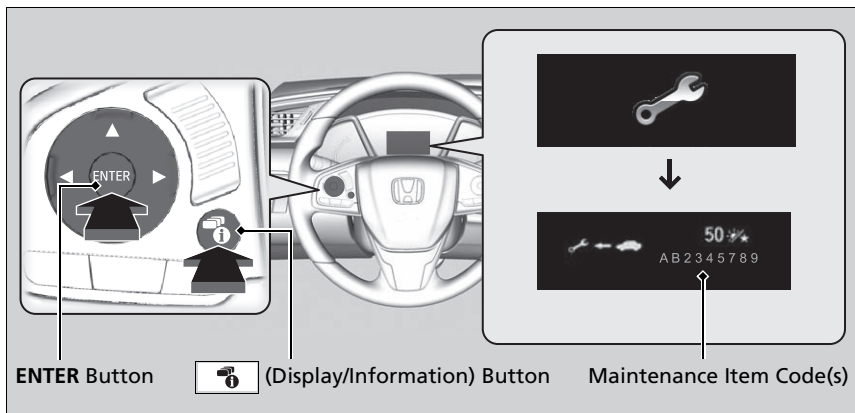

1. Turn the ignition switch to ON *1.
2. Press the button several times until is displayed.
3. Press **ENTER** to go to the Service Reminder system information screen. The maintenance service item and the remaining days appears on the driver information interface along with maintenance items due soon.

The system message indicator () stays on in the instrument panel after the maintenance period reached. Have the indicated maintenance done by a dealer immediately.



*1: Models with the keyless access system have an **ENGINE START/STOP** button instead of an ignition switch.

▶▶ Displaying the Service Reminder Information

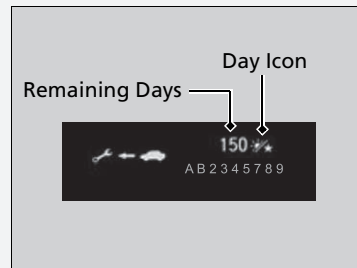
Based on engine operating conditions and engine oil conditions, the system calculates the remaining days before the next service is to be performed.

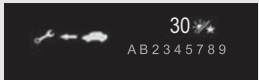
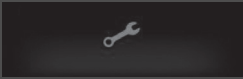
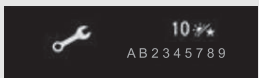
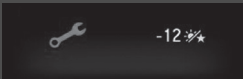

Warning Icons and Service Reminder Information on the Driver Information Interface

Warning Icon (Amber)	Service Reminder Information	Explanation	Information
<p>SERVICE DUE SOON</p> 		<p>One or more of the service items are required in less than 30 days. The remaining days are estimated based on your driving conditions.</p>	<p>The remaining days will be counted down per day.</p>
<p>SERVICE DUE NOW</p> 		<p>One or more of the service items are required in less than 10 days. The remaining days are estimated based on your driving conditions.</p>	<p>Have the indicated service performed as soon as possible.</p>
<p>SERVICE OVER DUE</p> 		<p>The indicated maintenance service is still not done after the remaining time reaches 0.</p>	<p>Your vehicle has passed the service required point. Immediately have the service performed and make sure to reset the service reminder system.</p>

■ Service Reminder Items

Service items displayed on the driver information interface are in code and icon. For an explanation of the service reminder codes and icons, refer to the service book that came with your vehicle.

■ Availability of the Service Reminder System

Even if the service reminder information appears on the driver information interface while pressing the  (display/information) button, this system is not available in some countries. Refer to the service book that came with your vehicle, or ask a dealer if you can use the service reminder system.

⊗ Availability of the Service Reminder System

If you are planning to take your vehicle outside the service reminder system applied countries, consult a dealer on how to record your service reminder information and schedule your maintenance service under the conditions of that country.

Resetting the Display

Reset the service reminder information display if you have performed the maintenance service.

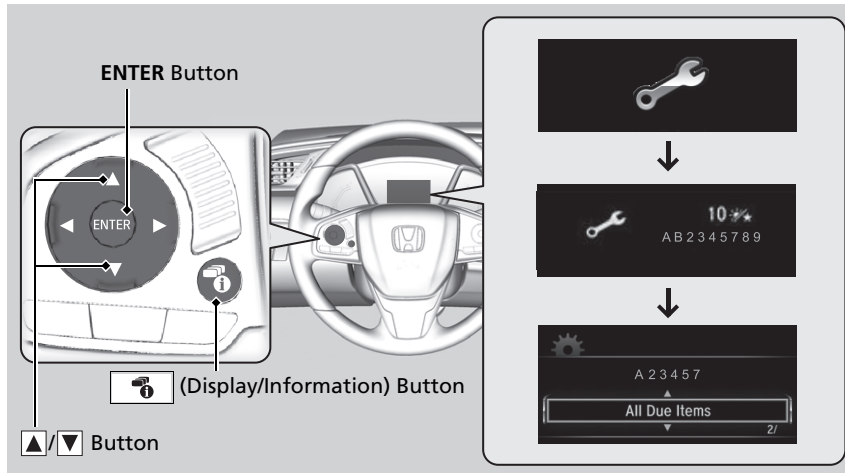

1. Turn the ignition switch to ON *1.
2. Press the (display/information) button repeatedly until the appears.
3. Press the **ENTER** button.
4. Press and hold the **ENTER** button for about 10 seconds to enter the reset mode.
5. Press to select a maintenance item to reset, or to select **All Due Items** (You can also select **Cancel** to end the process).
6. Press the **ENTER** button to reset the selected item.
7. Repeat from step 4 for other items you wish to reset.

*1: Models with the keyless access system have an **ENGINE START/STOP** button instead of an ignition switch.

Resetting the Display

NOTICE

Failure to reset the service reminder information after a maintenance service results in the system showing incorrect maintenance intervals, which can lead to serious mechanical problems.

The dealer will reset the service reminder information display after completing the required maintenance service. If someone other than a dealer performs maintenance service, reset the service reminder information display yourself.

Models with colour audio system

You can also reset the service reminder system information display using the customized features on the driver information interface.

Customized Features P. 161

Models with Display Audio

You can reset the service reminder system information display using the audio/information screen.

Customized Features P. 359

If the remaining distance to the next engine oil maintenance period is less than 3,000 km, you will see the maintenance required indicator every time you turn the ignition switch to ON *1. The indicator notify you when to change the engine oil, or when to bring your vehicle to a dealer for indicated maintenance services.

*1: Models with the keyless access system have an **ENGINE START/STOP** button instead of an ignition switch.

* Not available on all models

Displaying the Oil Monitor System Information

Certain maintenance items due soon, along with the estimated remaining oil life, appear on the driver information interface.

You can view them on the oil monitor system information screen at any time.

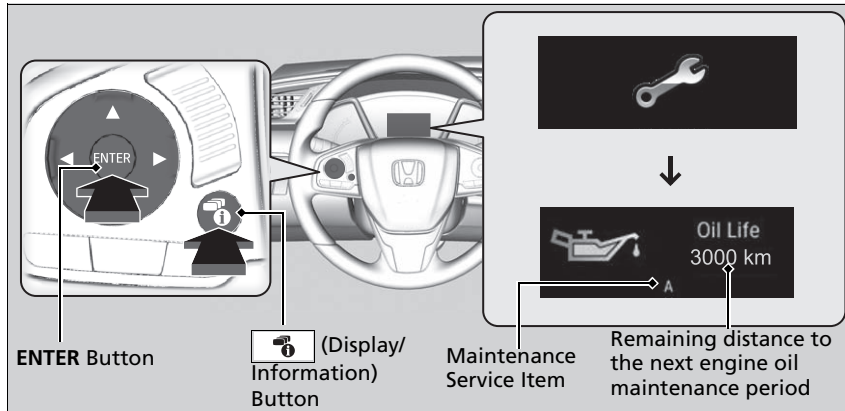

1. Turn the ignition switch to ON *1.
2. Press the (display/information) button several times until is displayed.
3. Press **ENTER** button to go to the oil monitor system information screen. The maintenance service item and the remaining distance appears on the driver information interface along with maintenance items due soon.

The system message indicator () stays on in the instrument panel after the maintenance period reached. Have the indicated maintenance done by a dealer immediately.

*1: Models with the keyless access system have an **ENGINE START/STOP** button instead of an ignition switch.

Displaying the Oil Monitor System Information

Based on the engine operating and engine oil conditions, the remaining distance to the next maintenance period is calculated and displayed.





By driving conditions, actual travel distance might be shorter than the displayed distance.

The type and content of the maintenance service items are as follows:

- A. Replace engine oil
- B. Replace engine oil and oil filter

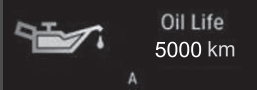
Independent of the oil monitor system information, perform maintenance after 1 year has elapsed since the last oil change.

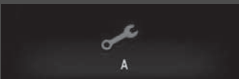
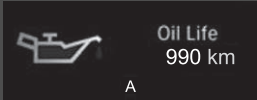
Oil Monitor System Information on the Driver Information Interface

Warning Icon (Amber)	Oil Life Display	Explanation	Information
<p>NORMAL</p> 		<p>When you select the oil monitor system information screen, it displays codes for maintenance items due at the next engine oil change, along with the percentage of engine oil life remaining.</p>	<p>—</p>
<p>SERVICE DUE SOON</p> 		<p>The engine oil life indicator starts to appear along with other due soon maintenance service item when the remaining distance to the next maintenance period is less than 3,000 km.</p>	<p>The engine oil is approaching the end of its service life.</p>
<p>SERVICE DUE NOW</p> 		<p>The maintenance service item which distance to the next maintenance period is less than 1,000 km appears.</p>	<p>The engine oil has almost reached the end of its service life, and the maintenance service item should be inspected and serviced as soon as possible.</p>
<p>SERVICE OVER DUE</p> 		<p>The remaining engine oil life has passed its service life.</p>	<p>The engine oil life has passed. The maintenance service item must be inspected and serviced immediately.</p>

Resetting the Display

Reset the engine oil monitor system information if you have performed the maintenance service.

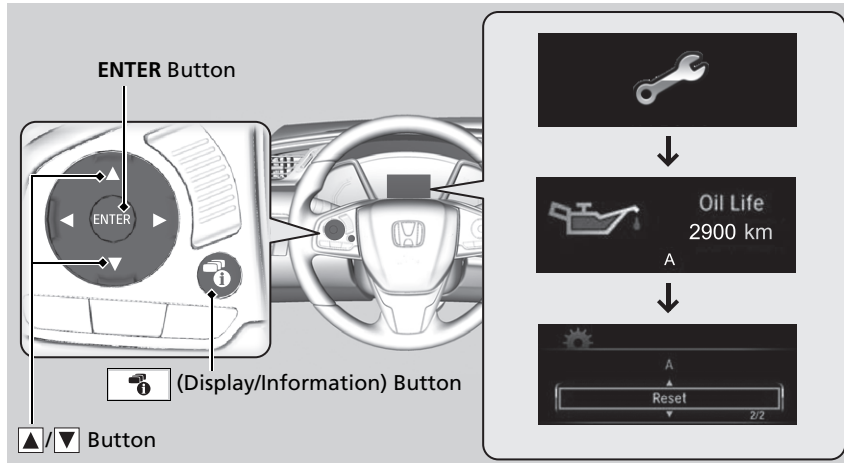

1. Turn the ignition switch to ON *1.
2. Press the (display/information) button repeatedly until the appears.
3. Press the **ENTER** button.
4. Press and hold the **ENTER** button for about 10 seconds to enter the reset mode.
5. Press button to select Reset.
6. Press the **ENTER** button to reset the selected item.

* 1: Models with the keyless access system have an **ENGINE START/STOP** button instead of an ignition switch.

Resetting the Display

NOTICE

Failure to reset the engine oil life after a maintenance service results in the system showing incorrect maintenance intervals, which can lead to serious mechanical problems.

The dealer will reset the engine oil life display after completing the required maintenance service. If someone other than a dealer performs maintenance service, reset the engine oil life display yourself.

Models with colour audio system

You can also reset the oil monitor system information display using the customized features on the driver information interface.

➤ **Customized Features** P. 161

Models with Display Audio

You can reset the oil monitor system information display using the audio/information screen.

➤ **Customized Features** P. 359

If your vehicle comes with the service book, the maintenance schedule for your vehicle is available in the book. For vehicles without the service book, refer to the following maintenance schedule.

The maintenance schedule outlines the minimum required maintenance that you should perform to ensure the troublefree operation of your vehicle. Due to regional and climatic differences, some additional servicing may be required. Please consult your warranty booklet for a more detailed description.

Maintenance work should be performed by properly trained and equipped technicians. Your authorised dealer meets all of these requirements.

GCC country models

Service at the indicated distance or time - whichever comes first.	km X 1,000		20	40	60	80	100	120	140	160	180	200
	months		12	24	36	48	60	72	84	96	108	120
Replace engine oil* ¹	Normal		Every 10,000 km or 1 year									
	Severe		Every 5,000 km or 6 months									
Replace engine oil filter* ¹	Normal		Every 20,000 km or 2 years									
	Severe		Every 10,000 km or 1 year									
Replace air cleaner element			Every 30,000 km									
Inspect valve clearance* ²			Every 120,000 km									
Replace fuel filter* ³						•				•		
Replace spark plugs			Every 100,000 km									
Inspect drive belts				•		•		•		•		•
Inspect idle speed								•				
Replace engine coolant			At 200,000 km or 10 years, thereafter every 100,000 km or 5 years									
Replace transmission fluid	MT	Normal						•				
		Severe			•			•			•	
	CVT			•		•		•		•		•
Inspect front and rear brakes			Every 10,000 km or 6 months									
Replace brake fluid			Every 3 years									
Replace dust and pollen filter (If equipped)			•	•	•	•	•	•	•	•	•	•
Rotate tyres (Check tyre inflation and condition at least once per month)			Every 10,000 km									

* 1: Only severe schedule is required in some countries: refer to local warranty booklet.

* 2: Sensory Method

Adjust the valves during service 120,000 km if they are noisy.

* 3: Refer to page 633 for replacement information under severe driving conditions.

Service at the indicated distance or time - whichever comes first.	km X 1,000	20	40	60	80	100	120	140	160	180	200
	months	12	24	36	48	60	72	84	96	108	120

Visually inspect the following items:

Tie rod ends, steering gear box, and boots Suspension components Driveshaft boots Battery electrolyte level	Every 10,000 km or 6 months										
Brake hoses and lines (including ABS) All fluid levels and condition of fluid Exhaust system Fuel lines and connections	•	•	•	•	•	•	•	•	•	•	•

Except European and GCC country models

Service at the indicated distance or time - whichever comes first.	km X 1,000		20	40	60	80	100	120	140	160	180	200
	months		12	24	36	48	60	72	84	96	108	120
Replace engine oil* ¹	Non Turbo	Normal	Every 10,000 km or 1 year									
		Severe	Every 5,000 km or 6 months									
	Turbo	When indicator comes on or 1 year										
Replace engine oil filter* ¹	Non Turbo	Normal	Every 20,000 km or 2 years									
		Severe	Every 10,000 km or 1 year									
	Turbo	When indicator comes on or 2 years										
Replace air cleaner element			Every 30,000 km									
Inspect valve clearance* ²			Every 120,000 km									
Replace fuel filter* ³						•				•		
Replace spark plugs	Iridium		Every 100,000 km									
Inspect drive belts				•		•		•		•		•
Inspect idle speed							•					
Replace engine coolant			At 200,000 km or 10 years, thereafter every 100,000 km or 5 years									
Replace transmission fluid	MT	Normal						•				
		Severe			•			•			•	
	CVT		•		•		•		•			•

* 1: Only severe schedule is required in some countries: refer to local warranty booklet.

* 2: Sensory Method

Adjust the valves during service 120,000 km if they are noisy.

* 3: Refer to page 633 for replacement information under severe driving conditions.

Service at the indicated distance or time - whichever comes first.	km X 1,000	20	40	60	80	100	120	140	160	180	200
	months	12	24	36	48	60	72	84	96	108	120
Inspect front and rear brakes	Every 10,000 km or 6 months										
Replace brake fluid	Every 3 years										
Replace dust and pollen filter (If equipped)	•	•	•	•	•	•	•	•	•	•	•
Check expiry date for tyre repair kit bottle (If equipped)	•	•	•	•	•	•	•	•	•	•	•
Rotate tyres (Check tyre inflation and condition at least once per month)	Every 10,000 km										
Visually inspect the following items:											
Tie rod ends, steering gear box, and boots Suspension components Driveshaft boots	Every 10,000 km or 6 months										
Brake hoses and lines (including ABS) All fluid levels and condition of fluid Exhaust system Fuel lines and connections	•	•	•	•	•	•	•	•	•	•	•

Except European models

If you drive your vehicle under severe conditions, you must have the following items served to the maintenance schedule indicated as Severe.

Items	Condition
Engine oil and filter	A, B, C, D and E
Transmission fluid	B, D

» Maintenance Schedule

The condition is considered as severe when you drive:

- A. less than 8 km, or less than 16 km in freezing temperatures per trip.
- B. In extremely hot temperature above 35°C.
- C. With extensive idling or long periods of stop-and-go.
- D. With a trailer towing*, or loaded roof rack, or in mountains.
- E. On muddy, dusty or de-iced roads.

* Not available on all models

Maintenance Record

Have your servicing dealer record all required maintenance below. Keep receipts for all work done on your vehicle.

Except European models

	Km or Month	Date	Sign or Stamp
20,000 km (or 12 Mo.)			
40,000 km (or 24 Mo.)			
60,000 km (or 36 Mo.)			
80,000 km (or 48 Mo.)			
100,000 km (or 60 Mo.)			
120,000 km (or 72 Mo.)			
140,000 km (or 84 Mo.)			
160,000 km (or 96 Mo.)			
180,000 km (or 108 Mo.)			
200,000 km (or 120 Mo.)			

Maintenance Items Under the Bonnet

1.5 L engine models

Washer Fluid (Blue Cap)

Engine Coolant
Reserve Tank

Reserve Tank Cap

Engine Oil Fill Cap

Engine Oil Dipstick
(Orange)

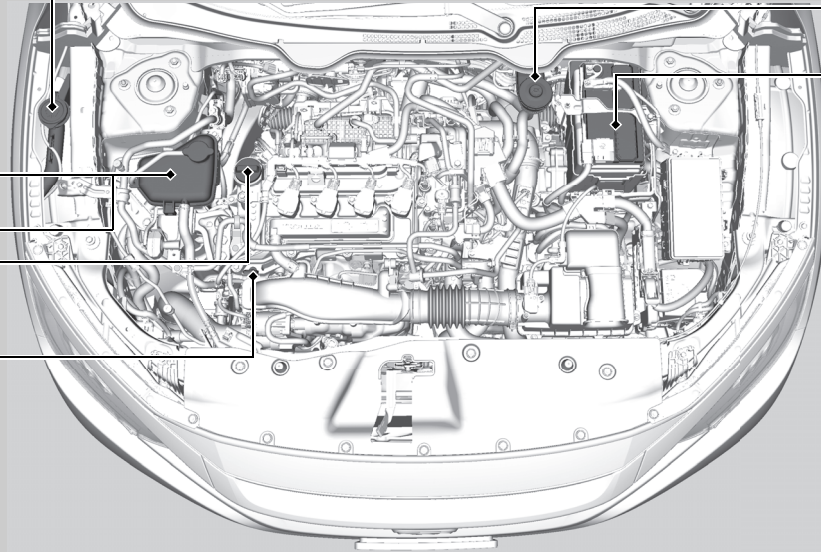

Brake Fluid
(Black Cap)

Battery

1.6 L engine models

Engine Oil Fill Cap

Engine Oil Dipstick
(Orange)

Brake Fluid
(Black Cap)

Washer Fluid
(Blue Cap)

Battery

Engine Coolant
Reserve Tank

Reserve Tank Cap

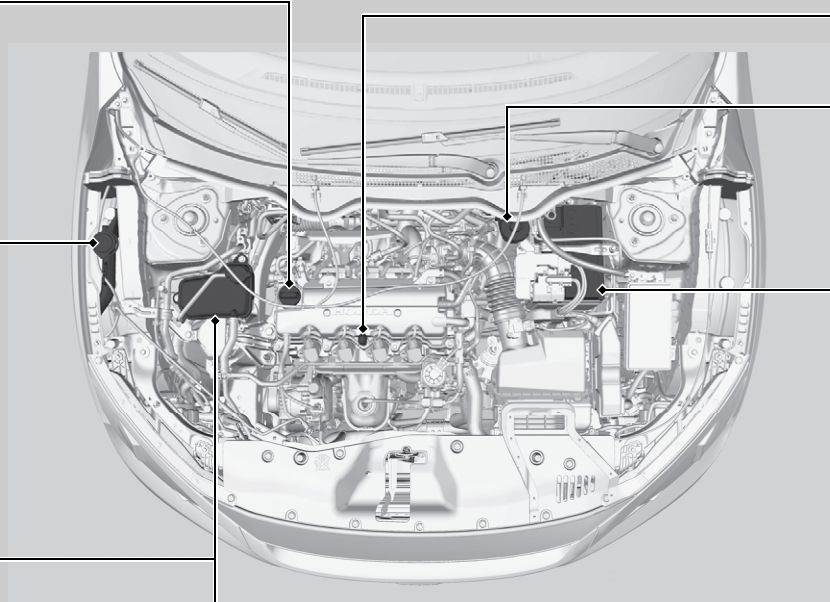

Opening the Bonnet

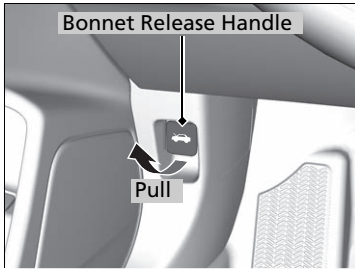

1. Park the vehicle on a level surface, and set the parking brake.
2. Pull the bonnet release handle under the driver's side lower outside corner of the dashboard.
 - The bonnet will pop up slightly.

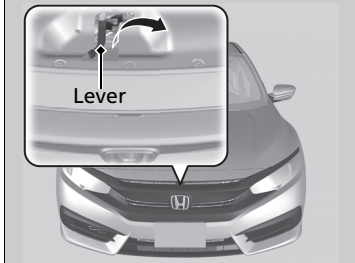

3. Pull up the bonnet latch lever (located under the front edge of the bonnet to the centre) and raise the bonnet. Once you have raised the bonnet slightly, you can release the lever.

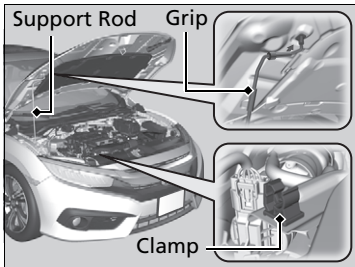

4. Remove the support rod from the clamp using the grip. Mount the support rod in the bonnet.

When closing, remove the support rod, and stow it in the clamp, then gently lower the bonnet. Remove your hand at a height of approximately 30 cm and let the bonnet close.

Opening the Bonnet

WARNING

The bonnet support rod can become very hot due to heat from the engine.

To ensure against possible burns, do not handle the metal section of the rod: Use the foam grip instead.

NOTICE

Do not open the bonnet when the wiper arms are raised. The bonnet will strike the wipers, and may damage either the bonnet or the wipers.

When closing the bonnet, check that the bonnet is securely latched.

If the bonnet latch lever moves stiffly, or if you can open the bonnet without lifting the lever, the latch mechanism should be cleaned and lubricated.

►► Opening the Bonnet

Models with Auto Idle Stop

Do not open the bonnet while the Auto Idle Stop function is activated.

Israeli, Turkish, and except Middle Eastern models



- Grab the foam.
- The support rod gets very hot.
- Refer to the owner's manual.

Recommended Engine Oil

Oil is a major contributor to your engine's performance and longevity. If you drive the vehicle with insufficient or deteriorated oil, the engine may fail or be damaged.

1.6 L engine models with service reminder system

- **Genuine Honda Motor Oil**
- **ACEA A3/B3**
- **ACEA A5/B5**

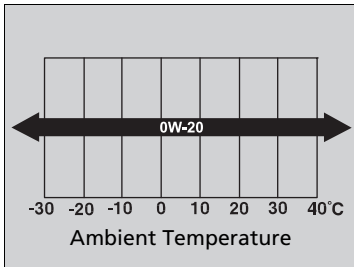

Use a Genuine Honda Motor oil or another commercial engine oil of suitable viscosity for the ambient temperature as shown.

If 0W-20 is not available, use 5W-30 or 0W-30.

Recommended Engine Oil

Engine Oil Additives

Your vehicle does not require oil additives. In fact, they may adversely affect the engine performance and durability.

ACEA viscosity oil is available for European models only.

Macedonian, Montenegrin, and Serbian models with 1.6 L engine

- **Genuine Honda Motor Oil**
- **ACEA A1/B1**
- **ACEA A3/B3**
- **ACEA A5/B5**

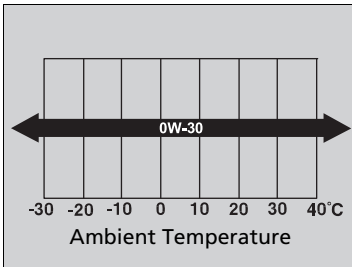

Use a Genuine Honda Motor oil or another commercial engine oil of suitable viscosity for the ambient temperature as shown.

If 0W-30 is not available, use 5W-30.

European models with 1.5 L engine

- **Genuine Honda Motor Oil*1**
- **ACEA A3/B3**
- **ACEA A5/B5**

*1: If you use 0W-20, you should use "Honda Engine Oil Type 2.0".

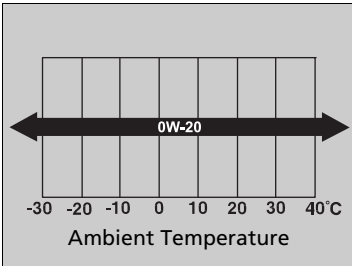

Use a Genuine Honda Motor oil or another commercial engine oil of suitable viscosity for the ambient temperature as shown.

0W-20 oil is formulated to improve fuel economy.

If Honda Engine Oil Type 2.0 is not available, use 0W-30 or 5W-30.

Except European models

- **Genuine Honda Motor Oil**
- **API service SM or higher grade fuel-efficient oil**

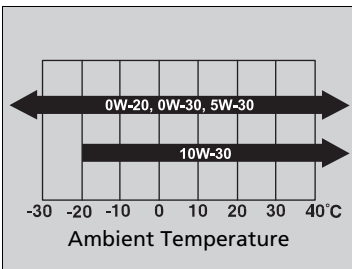

Use a Genuine Honda Motor oil or another commercial engine oil of suitable viscosity for the ambient temperature as shown.

0W-20 oil is formulated to improve fuel economy.

Oil Check

We recommend that you check the engine oil level every time you refuel.

Park the vehicle on level ground.

Wait approximately three minutes after turning the engine off before you check the oil.

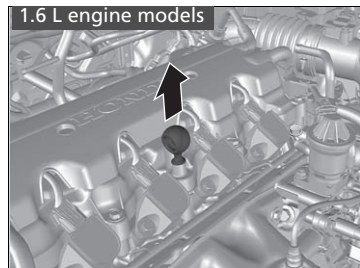
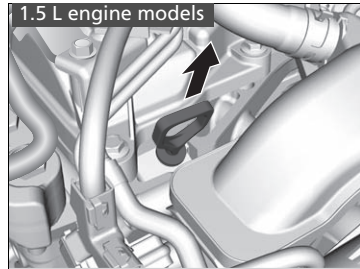

1. Remove the dipstick (orange).
2. Wipe the dipstick with a clean cloth or paper towel.
3. Insert the dipstick back all the way into its hole.

Oil Check

If the oil level is near or below the lower mark, slowly add oil, being careful not to overfill.

The amount of oil consumed depends on how the vehicle is driven and the climatic and road conditions encountered. The rate of oil consumption can be up to 1 litre per 1,000 km. Consumption is likely to be higher when the engine is new.

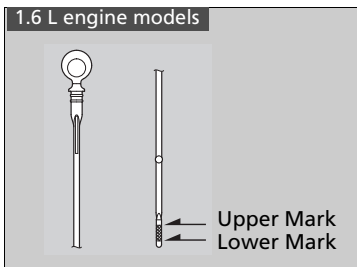
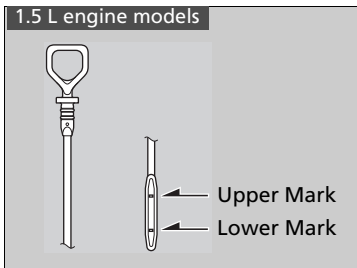

4. Remove the dipstick again, and check the level. It should be between the upper and lower marks. Add oil if necessary.

Adding Engine Oil

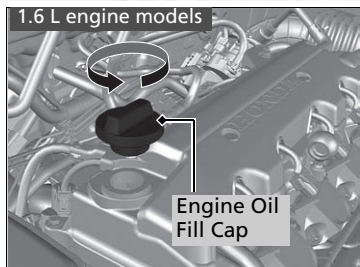
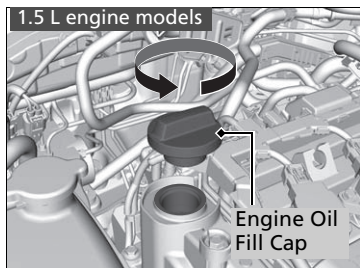

1. Unscrew and remove the engine oil fill cap.
2. Add oil slowly.
3. Reinstall the engine oil fill cap, and tighten it securely.
4. Wait for three minutes and recheck the engine oil dipstick.

►► Adding Engine Oil

NOTICE

Do not fill the engine oil above the upper mark. Overfilling the engine oil can result in leaks and engine damage.

If any oil spills, wipe it away immediately. Spilled oil may damage the engine compartment components.

Engine Coolant

Specified coolant: Honda All Season Antifreeze/Coolant Type 2

This coolant is premixed with 50% antifreeze and 50% water. Do not add any straight antifreeze or water.

We recommend you check the engine coolant level every time you refuel. Check the reserve tank. Add the engine coolant accordingly.

Checking the Coolant

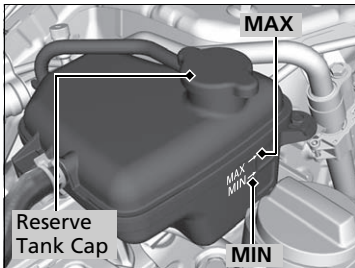

1. Make sure the engine and radiator are cool.
2. Check the amount of coolant in the reserve tank.
 - ▶ If the coolant level is below the **MIN** mark, add the specified coolant until it reaches the **MAX** mark.
3. Inspect the cooling system for leaks.

Engine Coolant

⚠ WARNING

Removing the reserve tank cap while the engine is hot can cause the coolant to spray out, seriously scalding you.

Always let the engine and radiator cool down before removing the reserve tank cap.

If Honda antifreeze/coolant is not available, you may use another major brand of non-silicate coolant as a temporary replacement. Check that it is a high quality coolant recommended for aluminium engines. Continued use of any non-Honda coolant can result in corrosion, causing the cooling system to malfunction or fail. Have the cooling system flushed and refilled with Honda antifreeze/coolant as soon as possible.

Do not add rust inhibitors or other additives to your vehicle's cooling system. They may not be compatible with the coolant or with the engine components.

If temperatures consistently below -30°C are expected, the coolant mixture should be changed to a higher concentration. Consult your Honda dealer for details about a suitable coolant mixture.

■ Adding the Coolant

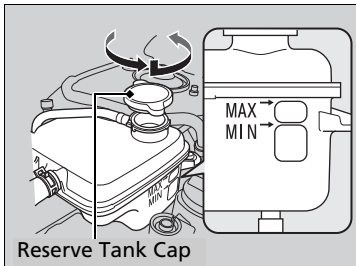

1. Make sure the engine and radiator are cool.
2. Turn the reserve tank cap 1/8 turn anticlockwise and relieve any pressure in the coolant system.
3. Push down and turn the reserve tank cap anticlockwise to remove it.
4. Pour coolant into the reserve tank until it reaches the **MAX** mark.
5. Put the reserve tank cap back on, and tighten it fully.

►► Adding the Coolant

NOTICE

Pour the fluid slowly and carefully so you do not spill any. Clean up any spills immediately; they can damage components in the engine compartment.

Engine Coolant Reserve Tank Cap*

Israeli, Turkish, and except Middle Eastern models



- Never open when hot.
- Hot coolant will scald you.
- Relief pressure valve begins to open at 108kPa.

* Not available on all models

Transmission Fluid

■ Continuously Variable Transmission (CVT) Fluid

Specified fluid: Honda HCF-2 Transmission Fluid

Have a dealer check the fluid level and replace if necessary. Follow your vehicle's maintenance service timing of when to change continuously variable transmission fluid.

➤ **Maintenance Schedule** P. 610

Do not attempt to check or change the continuously variable transmission fluid yourself.

■ Manual Transmission Fluid

Specified fluid: Honda Manual Transmission Fluid (MTF)

Have a dealer check the fluid level and replace if necessary. Follow your vehicle's maintenance service timing of when to change manual transmission fluid.

➤ **Maintenance Schedule** P. 610

Do not attempt to check or change the manual transmission fluid yourself.

⌘ Continuously Variable Transmission (CVT) Fluid

NOTICE

Do not mix Honda HCF-2 transmission fluids.

Using a transmission fluid other than Honda HCF-2 may adversely affect the operation and durability of your vehicle's transmission, may even damage it. Any damage caused by using a transmission fluid that is not equivalent to Honda HCF-2 is not covered by Honda's new vehicle limited warranty.

⌘ Manual Transmission Fluid

If Honda MTF is not available, you may use the API certificated SAE 0W-20 or 5W-20 viscosity motor oil as a temporary measure.

Replace with MTF as soon as possible. Motor oil does not contain the proper additives for the transmission and continued use can cause decreased shifting performance and lead to transmission damage.

Brake/Clutch* Fluid

Specified fluid: Brake Fluid with DOT 3 or DOT 4

Use the same fluid for both the brakes and clutch*.

Checking the Brake Fluid

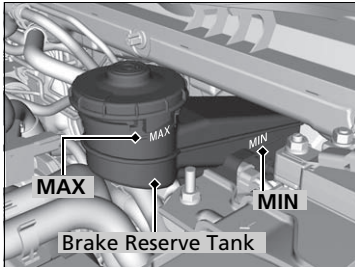

The fluid level should be between the **MIN** and **MAX** marks on the side of the reserve tank.

Manual transmission models

The brake fluid reserve tank is also used for your vehicle's clutch fluid. As long as you keep the brake fluid level as instructed above, there is no need for checking the clutch fluid level.

⚠ Brake/Clutch* Fluid

NOTICE

Brake fluid marked DOT 5 is not compatible with your vehicle's braking system and can cause extensive damage.

We recommend using a genuine product.

If the brake fluid level is at or below the **MIN** mark, have a dealer inspect the vehicle for leaks or worn brake pads as soon as possible.

* Not available on all models

Refilling Window Washer Fluid

Check the amount of window washer fluid by looking at the reservoir.

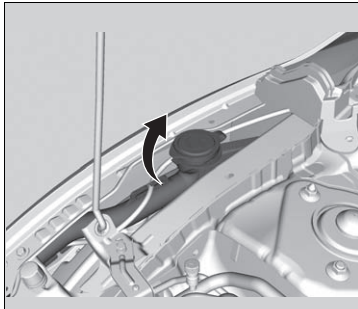

All models

Pour the washer fluid carefully. Do not overflow the reservoir.

If the level is low, fill the washer reservoir.

Except models with 1.6 L engine and Turkish models

If the washer fluid is low, a symbol appears on the driver information interface.

► Refilling Window Washer Fluid

Do not use engine antifreeze or a vinegar/water solution in the windscreen washer reservoir. Antifreeze can damage your vehicle's paint. A vinegar/water solution can damage the windscreen washer pump.

Use only commercially available windscreen washer fluid.

Avoid prolonged use of hard water to prevent lime scale build up.

Fuel Filter

Replace the fuel filter according to the time and distance recommendations in the maintenance schedule.

Except European models

It is recommended to replace the fuel filter every 40,000 km, or 2 years, if you suspect the fuel you are using is contaminated. In a dusty environment, the filter may become clogged sooner.

Have a qualified technician change the fuel filter. Fuel in the system can spray out and create a hazard if all fuel line connections are not handled correctly.

⌘ Fuel Filter

Models with service reminder system

The fuel filter should be replaced according to the service reminder indication.

Headlight Bulbs

When replacing, use the following bulbs.

- | | |
|-----------------------------|--|
| High beam headlight: | 60 W (HB3 for halogen bulb type)*
LED type* |
| Low beam headlight: | 55 W (H11 for halogen bulb type)*
LED type* |

High Beam Headlights

Models with halogen headlights

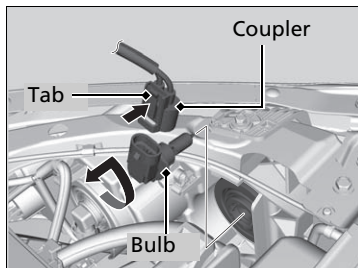

1. Push the tab to remove the coupler.
2. Rotate the old bulb anticlockwise to remove.
3. Insert a new bulb into the headlight assembly and turn it clockwise.
4. Insert the coupler into the connector of the bulb.

Headlight Bulbs

Models with halogen headlights

NOTICE

Halogen bulbs get very hot when lit. Oil, perspiration, or a scratch on the glass can cause the bulb to overheat and shatter.

The headlight aim is set by the factory, and does not need to be adjusted. However, if you regularly carry heavy items in the boot, have the aiming readjusted at a dealer or by a qualified technician.

When replacing a halogen bulb, handle it by its base, and protect the glass from contact with your skin or hard objects. If you touch the glass, clean it with denatured alcohol and a clean cloth.

Models with LED headlights

Headlights are LED type. Have an authorized Honda dealer inspect and replace the light assembly.

Low Beam Headlights

Models with halogen headlights

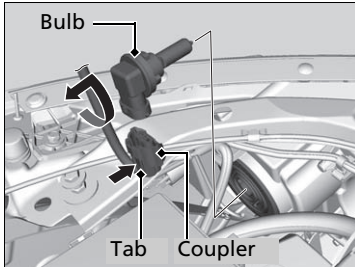

1. Push the tab to remove the coupler.
2. Rotate the old bulb anticlockwise to remove.
3. Insert a new bulb into the headlight assembly and turn it clockwise.
4. Insert the coupler into the connector of the bulb.

Front Fog Light Bulbs*

When replacing, use the following bulbs.

Front Fog Light: 35 W (H8 for halogen bulb type)*
LED*

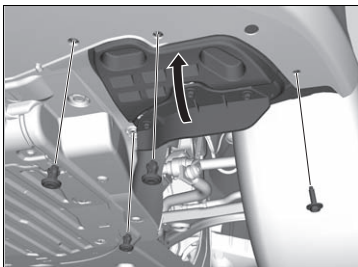

1. Remove the clips using a flat-tip screwdriver, remove the bolt, and push up the under cover.

▶▶ Front Fog Light Bulbs*

Models with LED front fog lights

Front fog lights are LED type. Have an authorized Honda dealer inspect and replace the light assembly.

NOTICE

Halogen bulbs get very hot when lit. Oil, perspiration, or a scratch on the glass can cause the bulb to overheat and shatter.

When replacing a halogen bulb, handle it by its plastic case, and protect the glass from contact with your skin or hard objects. If you touch the glass, clean it with denatured alcohol and a clean cloth.

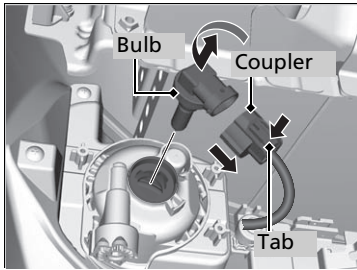

2. Push the tab to remove the coupler.
3. Rotate the old bulb anticlockwise to remove.
4. Insert a new bulb into the fog light assembly and turn it clockwise.
5. Insert the coupler into the connector of the bulb.

✘ Front Fog Light Bulbs*

Insert a flat-tip screwdriver, lift and remove the centre pin to remove the clip.

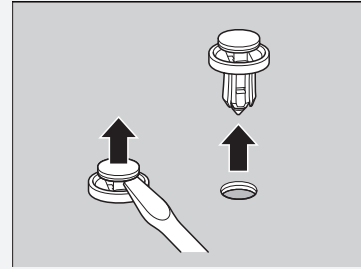

Insert the clip with the centre pin raised, and push until it is flat.

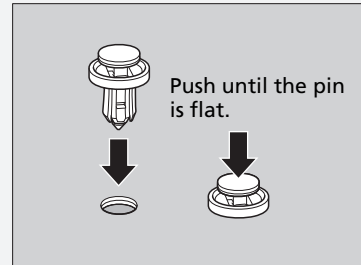

* Not available on all models

Front Turn Signal Light Bulbs

When replacing, use the following bulbs.

**Front Turn Signal Light: 21 W (Amber)*
LED***

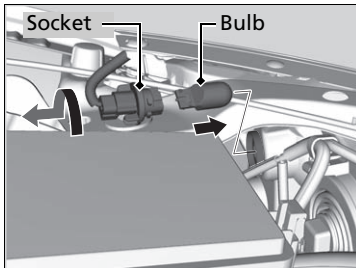

1. Turn the socket anticlockwise and remove it.
2. Remove the old bulb and insert a new bulb.

» Front Turn Signal Light Bulbs

Models with LED front turn signal lights

Front turn signal lights are LED type. Have an authorized Honda dealer inspect and replace the light assembly.

Front Side Marker Light Bulbs

When replacing, use the following bulbs.

Front Side Marker Light: 5 W (Amber)

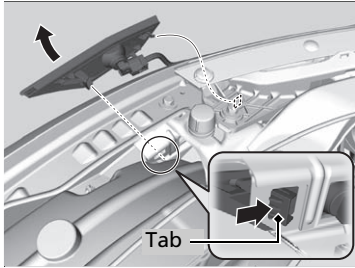

1. Push the tab to remove the light assembly.
2. Push the tab to remove the coupler.

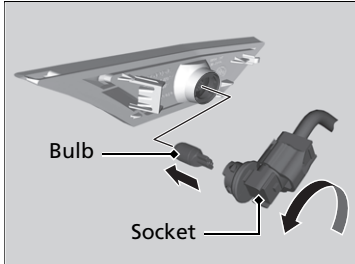

Driver side

3. Turn the socket anticlockwise to remove it, then remove the old bulb.
4. Insert a new bulb.

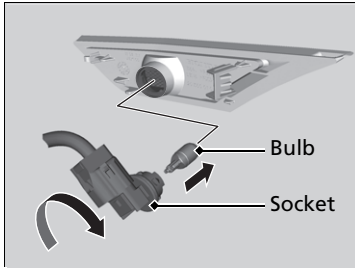

Passenger side

3. Turn the socket clockwise to remove it, then remove the old bulb.
4. Insert a new bulb.

Position/Daytime Running Lights

Position/daytime running lights are LED type. Have an authorized Honda dealer inspect and replace the light assembly.

Side Turn Signal/Emergency Indicator Lights

Side turn signal lights are LED type. Have an authorized Honda dealer inspect and replace the light assembly.

Brake Light, Taillight, Rear Turn Signal Light, Rear Fog Light* and Back-Up Light Bulbs

When replacing, use the following bulbs.

Brake Light: 21 W
Taillight: LED
Rear Turn Signal Light: 21 W (Amber)
Rear Fog Light: LED
Back-Up Light: 16 W

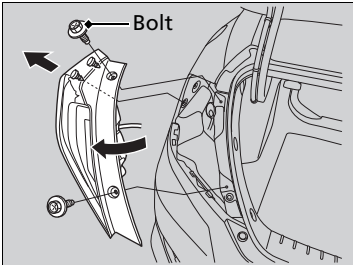

1. Use a Phillip-head screwdriver or socket to remove the bolts.
2. Pull the light assembly out of the rear pillar.

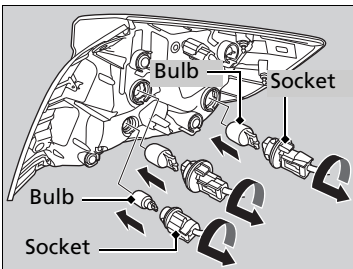

3. Turn the socket anticlockwise and remove it.
4. Remove the old bulb and insert a new bulb.
5. Slide the light assembly onto the guide on the body.
6. Align the pins with the body grommets, then push in until they fully seat.

► Brake Light, Taillight, Rear Turn Signal Light, Rear Fog Light* and Back-Up Light Bulbs

Taillights and rear fog light are LED type. Have an authorized Honda dealer inspect and replace the light assembly.

* Not available on all models

Taillights

Taillights are LED type. Have an authorized Honda dealer inspect and replace the light assembly.

Rear Licence Plate Light

Rear licence plate light is LED type. Have an authorized Honda dealer inspect and replace the light assembly.

High-Mount Brake Light Bulb

When replacing, use the following bulb.

High-Mount Brake Light: 21 W

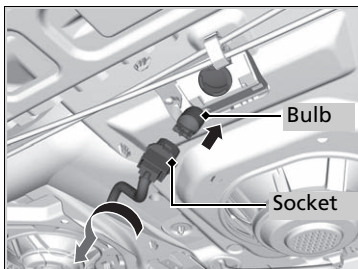

1. Open the boot.
2. Turn the socket anticlockwise and remove it.
3. Remove the old bulb and insert a new bulb.

Other Light Bulbs

■ Ceiling Light Bulb

When replacing, use the following bulb.

Ceiling Light: 8 W

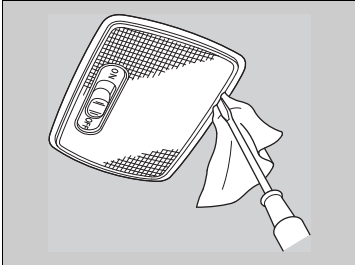

1. Pry on the edge of the cover using a flat-tip screwdriver to remove the cover.
 - ▶ Wrap the flat-tip screwdriver with a cloth to prevent scratches.

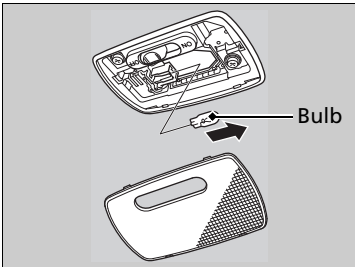

2. Remove the old bulb and insert a new bulb.

Models with Multi-View Rear Camera

■ Map Light Bulbs

When replacing, use the following bulbs.

Map Light: 8 W

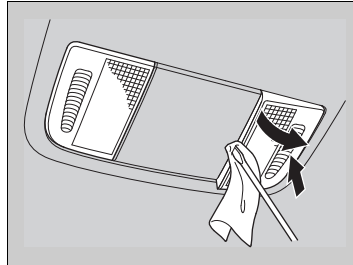

1. Push on the lens of the opposite side you are replacing.
2. Pry on the edge of the cover using a flat-tip screwdriver to remove the cover.
 - ▶ Wrap the flat-tip screwdriver with a cloth to prevent scratches.

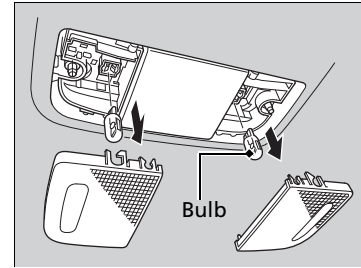

3. Remove the old bulb and insert a new bulb.

Models without Multi-View Rear Camera

■ **Map Light Bulbs**

When replacing, use the following bulbs.

Map Light: 8 W



1. Push on the lens of the opposite side you are replacing.
2. Pry on the edge between the lenses using a flat-tip screwdriver to remove the cover.
 - Wrap the flat-tip screwdriver with a cloth to prevent scratches.

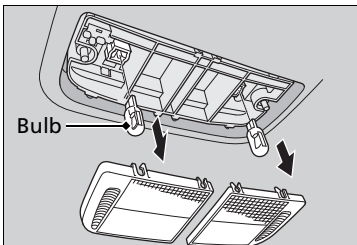

3. Remove the old bulb and insert a new bulb.

■ **Vanity Mirror Light Bulbs***

When replacing, use the following bulbs.

Vanity Mirror: 1.8 W

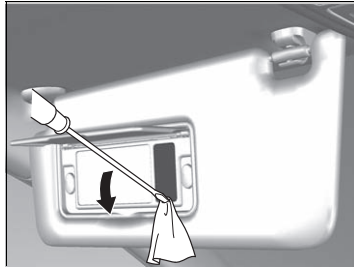

1. Pry on the edge of the cover using a flat-tip screwdriver to remove the cover.
 - Wrap the flat-tip screwdriver with a cloth to prevent scratches.

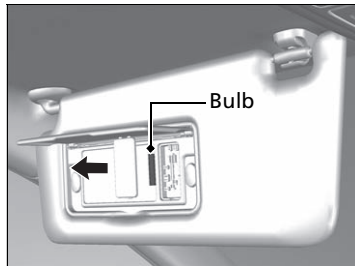

2. Remove the old bulb and insert a new bulb.

■ **Boot Light Bulb**

When replacing, use the following bulb.

Boot Light: 5 W

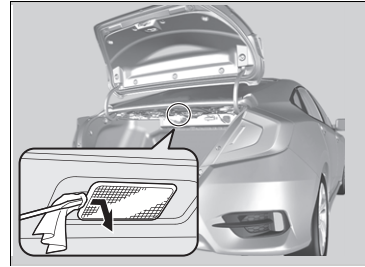

1. Pry on the edge of the cover using a flat-tip screwdriver to remove the cover.
 - Wrap the flat-tip screwdriver with a cloth to prevent scratches.

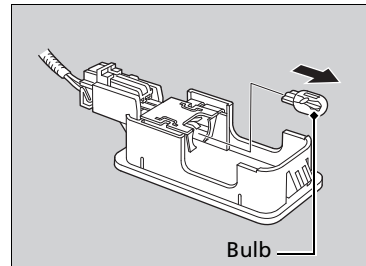

2. Remove the old bulb and insert a new bulb.

■ **Glove Box Light Bulb***

If you need a bulb replacement, consult a dealer.

* Not available on all models

Checking Wiper Blades

If the wiper blade rubber has deteriorated, it will leave streaks and the hard surfaces of the blade may scratch the window glass.

Changing the Wiper Blade Rubber

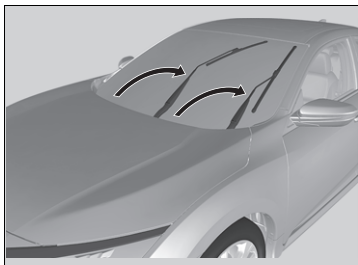

1. Turn the ignition switch to OFF [0]*1.
2. While holding the wiper switch in the **MIST** position, turn the ignition switch to ON [II]*1, then to LOCK [0]*1.
 - ▶ Both wiper arms are set to the maintenance position as shown in the image.

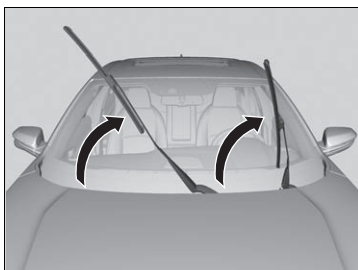

3. Lift both wiper arms.

Changing the Wiper Blade Rubber

NOTICE

Avoid dropping the wiper arm onto the windshield, it may damage the wiper arm and/or the windshield.

*1: Models with the keyless access system have an **ENGINE START/STOP** button instead of an ignition switch.

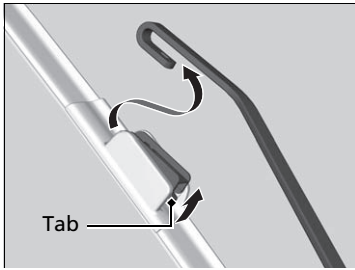

4. Press and hold the tab, then slide the holder off the wiper arm.

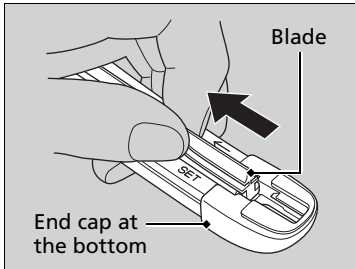

5. Pull the end of the wiper blade in the direction of the arrow in the image until it is out of the holder's end cap.

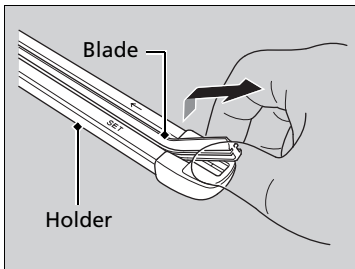

6. Pull the wiper blade in the opposite direction to slide it out of the holder.

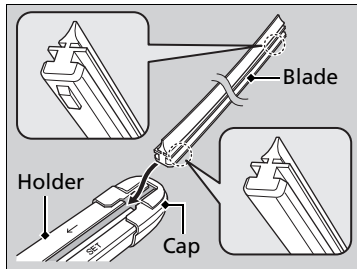

7. Insert the flat side of the new wiper blade onto the bottom part of the holder. Insert the blade all the way.
8. Install the end of the wiper blade into the cap.
9. Slide the holder onto the wiper arm until it locks.
10. Lower both wiper arms.
11. Turn the ignition switch to ON *1 and hold the wiper switch in the **MIST** position until both wiper arms return to the standard position.

*1: Models with the keyless access system have an **ENGINE START/STOP** button instead of an ignition switch.

Checking Tyres

To safely operate your vehicle, your tyres must be of the proper type and size, in good condition with adequate tread, and properly inflated.

■ Inflation guidelines

Properly inflated tyres provide the best combination of handling, tread life, and comfort. Refer to the driver's doorjamb label for the specified pressure.

Underinflated tyres wear unevenly, adversely affect handling and fuel economy, and are more likely to fail from overheating.

Overinflated tyres make your vehicle ride harshly, are more prone to road hazards, and wear unevenly.

Every day before you drive, look at each of the tyres. If one looks lower than the others, check the pressure with a tyre gauge.

At least once a month or before long trips, use a gauge to measure the pressure in all tyres, including the spare*. Even tyres in good condition can lose 10-20 kPa (0.1-0.2 kgf/cm², 1-2 psi) per month.

■ Inspection guidelines

Every time you check inflation, also examine the tyres and valve stems.

Look for:

- Bumps or bulges on the side or in the tread. Replace the tyre if you find any cuts, splits, or cracks in the side of the tyre. Replace it if you see fabric or cord.
- Remove any foreign objects and inspect for air leaks.
- Uneven tread wear. Have a dealer check the wheel alignment.
- Excessive tread wear.

➤ **Wear Indicators** P. 650

- Cracks or other damage around valve stem.

* Not available on all models

ⓘ Checking Tyres

⚠ WARNING

Using tyres that are excessively worn or improperly inflated can cause a crash in which you can be seriously hurt or killed.

Follow all instructions in this owner's manual regarding tyre inflation and maintenance.

Measure the air pressure when tyres are cold. This means the vehicle has been parked for at least three hours, or driven less than 1.6 km. If necessary, add or release air until the specified pressure is reached.

If checked when hot, tyre pressure can be as much as 30-40 kPa (0.3-0.4 kgf/cm², 4-6 psi) higher than if checked when cold.

Whenever tyre pressure is adjusted, you must calibrate the deflation warning system*.

➤ **Deflation Warning System** P. 556

Wear Indicators

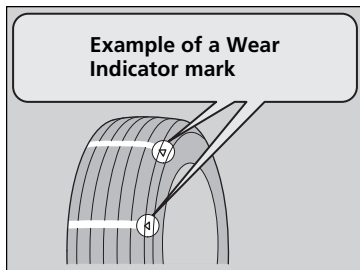

The groove where the wear indicator is located is 1.6 mm shallower than elsewhere on the tyre. If the tread has worn so that the indicator is exposed, replace the tyre. **Worn out tyres have poor traction on wet roads.**

Tyre Service Life

The life of your tyres is dependent on many factors, including driving habits, road conditions, vehicle loading, inflation pressure, maintenance history, speed, and environmental conditions (even when the tyres are not in use).

In addition to regular inspections and inflation pressure maintenance, it is recommended that you have annual inspections performed once the tyres reach five years old. All tyres, including the spare*, should be removed from service after 10 years from the date of manufacture, regardless of their condition or state of wear.

✎ Checking Tyres

Have a dealer check the tyres if you feel a consistent vibration while driving. New tyres and any that have been removed and reinstalled should be properly balanced.

High speed driving

We recommend that you do not drive faster than the posted speed limits and conditions allow. If you drive at sustained high speeds (over 160 km/h), adjust the cold tyre pressures as shown below to avoid excessive heat build up and sudden tyre failure.

Tyre Size	215/50R17 91V
Pressure	Front: 240 kPa (2.4 kgf/cm ² , 35 psi) Rear: 230 kPa (2.3 kgf/cm ² , 33 psi)

Tyre and Wheel Replacement

Replace your tyres with radials of the same size, load range, speed rating, and maximum cold tyre pressure rating (as shown on the tyre's sidewall). Using tyres of a different size or construction can cause certain vehicle systems such as the ABS and Vehicle Stability Assist (VSA) system to work incorrectly.

It is best to replace all four tyres at the same time. If that isn't possible, replace the front or rear tyres in pairs.

Make sure that the wheel's specifications match those of the original wheels.

⚠ Tyre and Wheel Replacement

⚠ WARNING

Installing improper tyres on your vehicle can affect handling and stability. This can cause a crash in which you can be seriously hurt or killed.

Always use the size and type of tyres recommended in the tyre information label on your vehicle.

Tyre Rotation

European models with service reminder system

Rotating tyres according to the maintenance messages on the driver information interface* helps to distribute wear more evenly and increase tyre life.

European models without service reminder system

Rotating tyres according to the maintenance schedule helps to distribute wear more evenly and increase tyre life.

Models with a compact spare tyre or tyre repair kit

■ Tyres without rotation marks

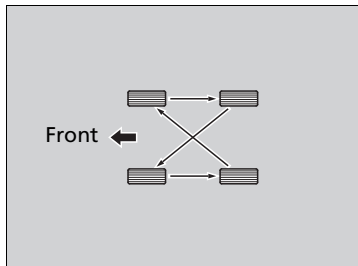

Rotate the tyres as shown here.

■ Tyres with rotation marks

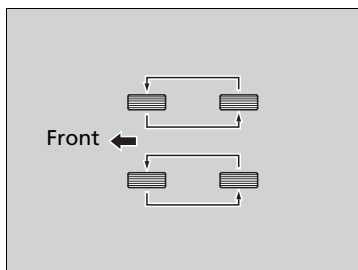

Rotate the tyres as shown here.

►► Tyre Rotation

Tyres with directional tread patterns should only be rotated front to back (not from one side to the other). Directional tyres should be mounted with the rotation indication mark facing forward, as shown below.

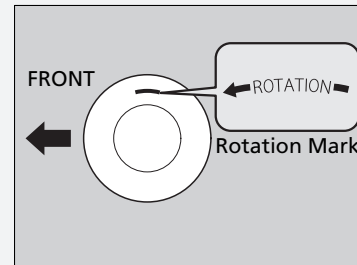

When the tyres are rotated, make sure the air pressures are checked.

Whenever tyre pressure is adjusted, you must calibrate the deflation warning system*.

► **Deflation Warning System** P. 556

Models with a full-size spare tyre

■ **Your Vehicle's Tyre Rotation Pattern**

Rotate the tyres as shown here.

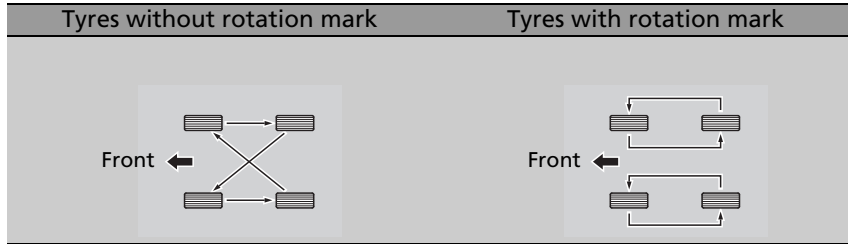

Rotate the tyres, including a spare, as shown here.

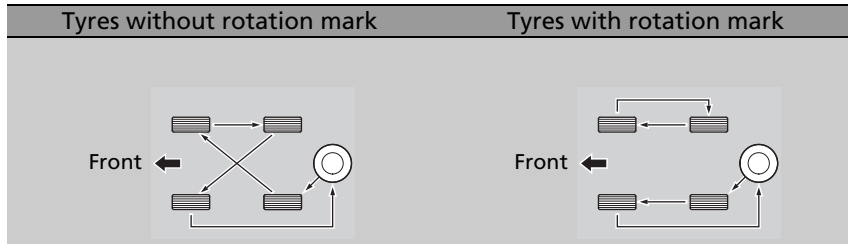

Snow Traction Devices

If driving on snowy or frozen roads, mount winter tyres, or tyre chains; reduce speed; and maintain sufficient distance between vehicles when driving.

Be particularly careful when operating the steering wheel or brakes to prevent skidding.

Use tyre chains, winter tyres, or all season tyres when necessary or according to the law.

When mounting, refer to the following points.

For winter tyres:

- Select the size and load ranges that are the same as the original tyres.
- Mount the tyres to all four wheels.

For tyre chains:

- Consult a dealer before purchasing any type of chains for your vehicle.
- Install them on the front tyres only.
- Because your vehicle has limited tyre clearance, we strongly recommend using the chains listed below:

Original Tyre Size*1	Chain Type
215/55R16 93H	RUD-matic classic 48489
215/50R17 91V	

*1: Original tyre size is mentioned on the tyre information label on the driver's doorjamb.

►► Snow Traction Devices

WARNING

Using the wrong chains, or not properly installing chains, can damage the brake lines and cause a crash in which you can be seriously injured or killed.

Follow all instructions in this owner's manual regarding the selection and use of tyre chains.

NOTICE

Traction devices that are the wrong size or improperly installed can damage your vehicle's brake lines, suspension, body, and wheels. Stop driving if they are hitting any part of the vehicle.

According to the EEC Directive for tyres, when winter tyres are used, it is necessary to affix a sticker with the allowable max. speed of the winter tyres clearly in the field of view of the driver, if the designed max. speed of vehicle is higher than the allowed max. speed of winter tyre. A sticker is obtainable from your tyre dealer. If you have any question, consult a dealer.

When tyre chains are mounted, follow the chain manufacturer's instructions regarding vehicle operational limits.

- Follow the chain manufacturer's instruction when installing. Mount them as tightly as you can.
- Check that the chains do not touch the brake lines or suspension.
- Drive slowly.

☒ Snow Traction Devices

Use tyre chains only in an emergency or when they are legally required for driving through a certain area.

Use greater caution when driving with tyre chains on snow or ice. They may have less-predictable handling than good winter tyres without chains.

If your vehicle is equipped with summer tyres, be aware that these tyres are not designed for winter driving conditions. For more information, contact a dealer.

Checking the Battery

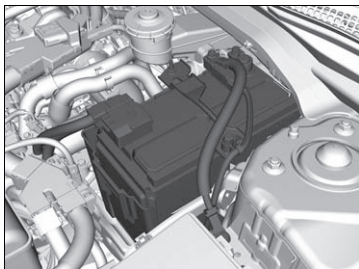

Models with Information display

Check the battery condition by looking at the fluid level. The upper and lower level marks are shown on the battery case. If the fluid level is below the lower mark, contact a dealer.

Models with driver information interface

The condition of the battery is monitored by a sensor located on the negative terminal of the battery. If there is a problem with this sensor, the driver information interface will display a warning message. If this happens, have you vehicle inspected by a dealer.

All type

Check the battery terminals for corrosion monthly.

If your vehicle's battery is disconnected or goes dead:

- The audio system is disabled.
 - **Audio System Theft Protection*** P. 256
- The clock resets.
 - **Clock** P. 170

» Battery

⚠ WARNING

The battery gives off explosive hydrogen gas during normal operation.

A spark or open flame can cause the battery to explode with enough force to kill or seriously hurt you.

Keep all sparks, open flames, and smoking materials away from the battery.

Wear protective clothing and a face shield, or have a skilled technician do any battery maintenance.

⚠ WARNING

The battery contains sulfuric acid (electrolyte) which is highly corrosive and poisonous.

Getting electrolyte in your eyes or on your skin can cause serious burns. Wear protective clothing and eye protection when working on or near the battery.

Swallowing electrolyte can cause fatal poisoning if immediate action is not taken.

KEEP OUT OF THE REACH OF CHILDREN

Charging the Battery

Disconnect both battery cables to prevent damaging your vehicle's electrical system. Always disconnect the negative (-) cable first, and reconnect it last.

⚠ Battery

Emergency Procedures

Eyes: Flush with water from a cup or other container for at least 15 minutes. (Water under pressure can damage the eye.) Call a physician immediately.

Skin: Remove contaminated clothing. Flush the skin with large quantities of water. Call a physician immediately.

Swallowing: Drink water or milk. Call a physician immediately.

When you find corrosion, clean the battery terminals by applying a baking powder and water solution.

Clean the terminals with a damp towel. Cloth/towel dry the battery. Coat the terminals with grease to help prevent future corrosion.

When replacing the battery, the replacement must be of the same specifications.

Consult a dealer for more information.

Models with Auto Idle Stop

The battery installed in this vehicle is specifically designed for a model with Auto Idle Stop. Using a battery other than this specified type may shorten the battery life, and prevent Auto Idle Stop from activating. If you need to replace the battery, make sure to select the specified type. Ask a dealer for more details.

➤ **Specifications** P. 724

Replacing the Battery

When you remove and replace the battery, always follow the maintenance safety and the warnings for when checking the battery to prevent potential hazards.

➤ **Maintenance Safety** P. 599

➤ **Checking the Battery** P. 656

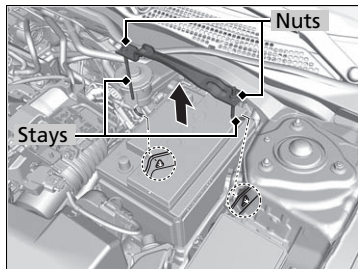
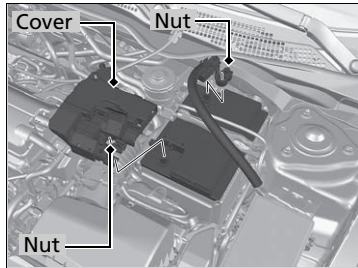

1. Turn the ignition switch to LOCK *1. Open the bonnet.
2. Loosen the nut on the negative battery cable, then disconnect the cable from the negative (-) terminal.
3. Open the positive battery terminal cover. Loosen the nut on the positive battery cable, then disconnect the cable from the positive (+) terminal.
4. Loosen the nut on each side of the battery bracket with a wrench.
5. Pull the bottom end of each battery stay out of the hole on the battery base, and remove the combination of the battery bracket and the stays.

*1: Models with the keyless access system have an **ENGINE START/STOP** button instead of an ignition switch.

▶▶ Replacing the Battery

NOTICE

An improperly disposed of battery can be harmful to the environment and human health. Always confirm local regulations for battery disposal.

This symbol on the battery means that this product must not be treated as household waste.



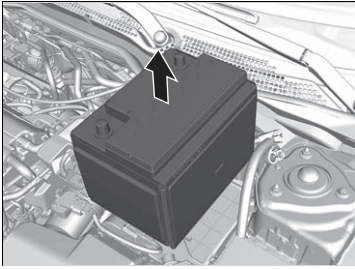

6. Remove the battery cover.
7. Take out the battery carefully.

☒ Replacing the Battery

Always disconnect the negative (-) cable first, and reconnect it last.

To install a new battery, reverse this procedure.

Battery Label



▶▶ Battery Label

DANGER

- Keep flames and sparks away from the battery. The battery produces explosive gas that can cause an explosion.
- Wear eye protection and rubber gloves when handling the battery to avoid risk of burns or loss of eyesight if exposed to battery electrolyte.
- Do not allow children to handle the battery, under any circumstance. Ensure that anyone handling the battery has a proper understanding of the hazards and correct handling procedures involved.
- Handle battery electrolyte with extreme care, as it contains dilute sulfuric acid. Exposure to eyes or skin can cause burns or loss of eyesight.
- Read this manual carefully, and understand it before handling the battery. Failure to do so can cause personal injury and damage to the vehicle.
- Do not use the battery if the level of electrolyte is at or below the recommended level. Using the battery with low electrolyte can cause it to explode, causing serious injury.

Replacing the Button Battery

If the indicator does not come on when the button is pressed, replace the battery.

Retractable Key*

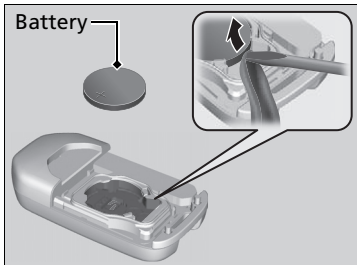
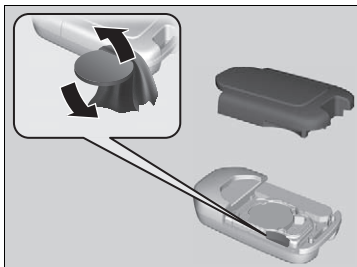

Battery type: CR2032

1. Remove the upper half of the cover by carefully prying on the edge with a coin.
▶ Wrap a coin with a cloth to prevent scratching the retractable key.
2. Remove the button battery with the small flat-tip screwdriver.
3. Make sure to replace the battery with the correct polarity.

Replacing the Button Battery

NOTICE

An improperly disposed of battery can damage the environment. Always confirm local regulations for battery disposal.

Replacement batteries are commercially available or at a dealer.

This symbol on the battery means that this product must not be treated as household waste.



* Not available on all models

■ Keyless Remote*

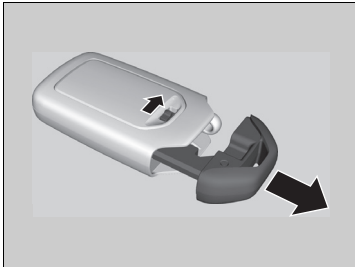

Battery type: CR2032

1. Remove the built-in key.
2. Remove the upper half by carefully prying on the edge with a coin.
 - ▶ Wrap a coin with a cloth to prevent scratching the keyless remote.
3. Make sure to replace the battery with the correct polarity.

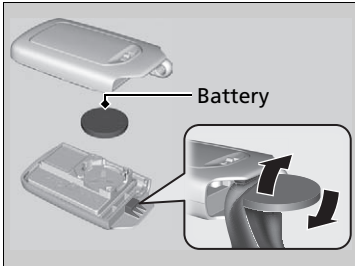

Air Conditioning*

For proper and safe operation of the climate control system, the refrigerant system should only be served by a qualified technician.

Never repair or replace the air conditioning evaporator (cooling coil) with one removed from a used or salvaged vehicle.

Climate Control System Maintenance

NOTICE

Vented refrigerant is harmful to the environment. To avoid refrigerant from venting, never replace the evaporator with one removed from a used or salvaged vehicle.

Refrigerant in your vehicle's air conditioning system is flammable and can be ignited during servicing if proper procedures are not followed.

The air conditioner label is found under the bonnet:



-  : Caution
-  : Flammable Refrigerant
-  : Requires Registered Technician to Service
-  : Air Conditioning System

* Not available on all models

Dust and Pollen Filter

■ When to Replace the Dust and Pollen Filter

Replace the dust and pollen filter according to your vehicle's recommended maintenance schedule. It is recommended to replace the filter even sooner if the vehicle has been driven in a dusty environment.

➤ **Maintenance Schedule** P. 610

■ How to Replace the Dust and Pollen Filter

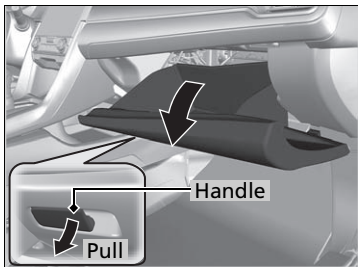

1. Open the glove box.

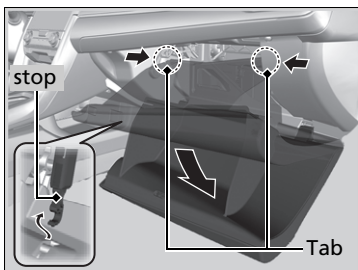

2. Push the stop on the driver's side of the glove box to detach it from the glove box.
3. Disengage the two tabs by pushing on each side panel.
4. Pivot the glove box out of the way.

►► Dust and Pollen Filter

Using an air freshener may reduce the deodorizing effect of the dust and pollen filter, and may reduce its life.

If the airflow from the climate control system deteriorates noticeably, and the windows fog up easily, the filter may need to be replaced.

The dust and pollen filter collects pollen, dust, and other debris in the air.

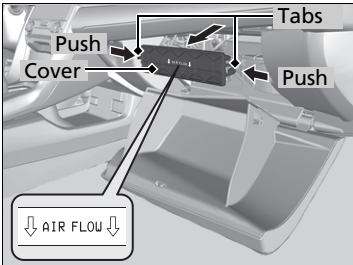

5. Push in the tabs on the corners of the filter case cover, and remove it.

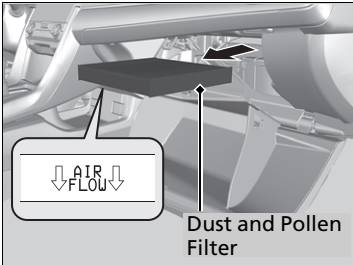

6. Remove the filter from the case.

7. Install a new filter in the case.

► Put the **AIR FLOW** arrow directed side down.

▣ Dust and Pollen Filter

If you are not sure how to replace the dust and pollen filter, have it replaced by a dealer.

Models with glove box damper

NOTICE

When to install the dust and pollen filter:

1. Install the filter case cover.
2. Remove the driver's side claw at the bottom of the glove box.
3. Pivot the glove box up into position. Install the tabs back in place.
4. Open the glove box to angle of about 30 °.
5. Install the hook portion of the stop to the glove box. When installing the stop, put a hand from the bottom of the glove box.
6. Install the claw at bottom of the glove box.

After installing the glove box, open and close several times and make sure the glove box is installed properly.

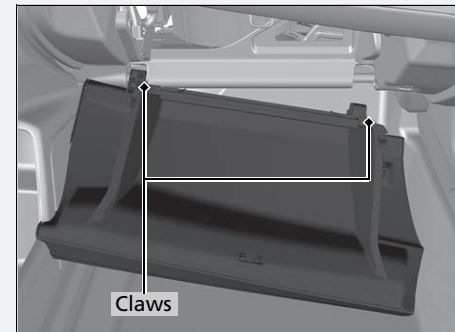

Interior Care

Use a vacuum cleaner to remove dust before using a cloth.

Use a damp cloth with a mixture of mild detergent and warm water to remove dirt.

Use a clean cloth to remove detergent residue.

■ Cleaning Seat Belts

Use a soft brush with a mixture of mild soap and warm water to clean the seat belts.

Let the belts air dry. Wipe the loops of the seat belt anchors using a clean cloth.

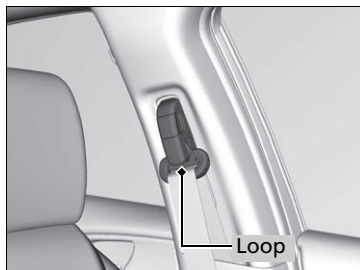

■ Cleaning the Window

Wipe using a glass cleaner.

☒ Interior Care

Do not spill liquids inside the vehicle. Electrical devices and systems may malfunction if liquids are splashed on them.

Do not use silicone based sprays on electrical devices such as audio devices and switches.

Doing so may cause the items to malfunction or cause a fire inside the vehicle.

If a silicone based spray is inadvertently used on electrical devices, consult a dealer.

Depending on their composition, chemicals and liquid aromatics may cause discolouration, wrinkles, and cracking to resin-based parts and textiles.

Do not use alkali solvents or organic solvents such as benzene or petrol.

After using chemicals, make sure to gently wipe them away using a dry cloth.

Do not place used cloths on top of resin based parts or textiles for long periods of time without washing.

Be careful not to spill a liquid type air freshener.

☒ Cleaning the Window

Wires are mounted to the inside of the rear window. Wipe along the same direction as the wires with a soft cloth so as not to damage them.

Be careful not to spill fluids, such as water or glass cleaner, on or around the cover of both the front sensor camera and the rainfall/light sensor.

■ Floor Mats*

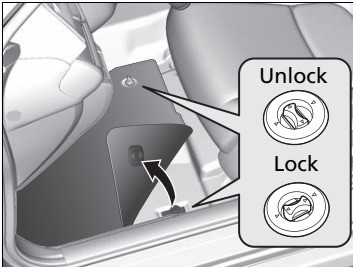

The driver's floor mat hooks over floor anchors, which keep them from sliding forward. To remove a mat for cleaning, turn the anchor knobs to the unlock position. When reinstalling the mat after cleaning, turn the knobs to the lock position.

Do not put additional floor mats on top of the anchored mat.

■ Maintaining Genuine Leather*

To properly clean leather:

1. Use a vacuum or soft dry cloth first to remove any dirt or dust.
2. Clean the leather with a soft cloth dampened with a solution comprised of 90% water and 10% neutral soap.
3. Wipe away any soap residue with a clean damp cloth.
4. Wipe away residual water and allow leather to air dry in the shade.

▣ Floor Mats*

If you use any floor mats that were not originally provided with your vehicle, make sure they are designed for your specific vehicle, fit correctly, and are securely anchored by the floor anchors. Position the rear seat floor mats properly. If they are not properly positioned, the floor mats can interfere with the front seat functions.

▣ Maintaining Genuine Leather*

It is important to clean or wipe away dirt or dust as soon as possible. Spills can soak into leather resulting in stains. Dirt or dust can cause abrasions in the leather. In addition, please note that some dark coloured clothing can rub onto the leather seats resulting in discolouration or stains.

* Not available on all models

Exterior Care

Dust off the vehicle body after you drive.

Regularly inspect your vehicle for scratches on painted surfaces. A scratch on a painted surface can result in body rust. If you find a scratch, promptly repair it.

■ Washing the Vehicle

Wash the vehicle regularly. Wash more frequently when driving in the following conditions:

- If driving on roads with road salt.
- If driving in coastal areas.
- If tar, soot, bird droppings, insects, or tree sap are stuck to painted surfaces.

■ Using an Automated Car Wash

- Make sure to follow the instructions indicated on the automated car wash.
- Fold in the door mirrors.
- Automatic intermittent wiper equipment vehicles, wipers switch to OFF.

■ Using High Pressure Cleaners

- Keep sufficient distance between the cleaning nozzle and the vehicle body.
- Take particular care around the windows. Standing too close may cause water to enter the vehicle interior.
- Do not spray high pressure water directly into the engine compartment. Instead, use low pressure water and a mild detergent.

▶ Washing the Vehicle

Do not spray water into the air intake vents. It can cause a malfunction.

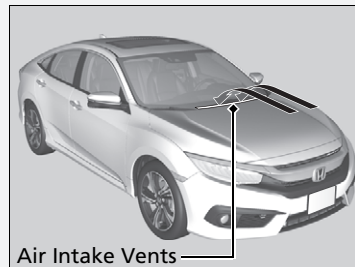

Air Intake Vents

Do not spray water onto the fuel fill door directly. A high-pressure spray may cause it to open.

Do not spray water onto the capless unit when the fuel fill door is open. It can cause damage to the fuel system or engine.

■ Applying Wax

A good coat of automotive body wax helps to protect your vehicle's paint from the elements. Wax will wear off over time and expose your vehicle's paint to the elements, so reapply as necessary.

■ Maintaining the Bumpers and Other Resin Coated Parts

If you get petrol, oil, engine coolant, or battery fluid on resin coated parts, they may be stained or the coating may peel. Promptly wipe it away using a soft cloth and clean water.

■ Cleaning the Window

Wipe using a glass cleaner.

■ Maintaining Aluminium Wheels

Aluminium is susceptible to deterioration caused by salt and other road contaminants. When necessary, as early as possible use a sponge and mild detergent to wipe away these contaminants. Do not use a stiff brush or harsh chemicals (including some commercial wheel cleaners). These can damage the protective finish on aluminium alloy wheels, resulting in corrosion. Depending on the type of finish, the wheels also may lose their luster or appear burnished. To avoid water stains, wipe the wheels dry with a cloth while they are still wet.

☒ Applying Wax

NOTICE

Chemical solvents and strong cleaners can damage the paint, metal, and plastic on your vehicle. Wipe away spills immediately.

☒ Maintaining the Bumpers and Other Resin Coated Parts

Ask a dealer about the correct coating material when you want to repair the painted surface of the parts made of resin.

■ Fogged Exterior Light Lenses

The inside lenses of exterior lights (headlights, brake lights, etc.) may fog temporarily if you have driven in the rain, or after the vehicle has been run through a car wash. Dew condensation also may build up inside the lenses when there is a significant enough difference between the ambient and inside lens temperatures (similar to vehicle windows fogging up in rainy conditions). These conditions are natural processes, not structural design problems in the exterior lights.

Lens design characteristics may result in moisture developing on the light lens frame surfaces. This also is not a malfunction.

However, if you see large amounts of water accumulation, or large water drops building up inside the lenses, have your vehicle inspected by a dealer.

Accessories

When installing accessories, check the following:

- Do not install accessories on the windshield. They can obstruct your view and delay your reaction to driving conditions.
- Do not install any accessories over areas marked SRS Airbag, on the sides or backs of the front seats, on front or side pillars, or near the side windows. Accessories installed in these areas may interfere with proper operation of the vehicle's airbags or may be propelled into you or another occupant if the airbags deploy.
- Be sure electronic accessories do not overload electrical circuits or interfere with proper operation of your vehicle.
 - **Fuses** P. 710
- Before installing any electronic accessory, have the installer contact a dealer for assistance. If possible, have a dealer inspect the final installation.

Modifications

Do not modify your vehicle in a manner that may affect its handling, stability, or reliability, or install non-genuine Honda parts or accessories that may have a similar effect.

Even minor modifications to vehicle systems can affect overall vehicle performance. Always make sure all equipment is properly installed and maintained, and do not make any modification to your vehicle or its systems that might cause your vehicle to no longer meet your country's and local regulations.

Do not modify or attempt to repair any of the electrical components.

Accessories and Modifications

WARNING

Improper accessories or modifications can affect your vehicle's handling, stability, and performance, and cause a crash in which you can be seriously hurt or killed.

Follow all instructions in this owner's manual regarding accessories and modifications.

When properly installed, mobile phones, alarms, two-way radios, radio antennas, and low-powered audio systems should not interfere with your vehicle's computer controlled systems, such as your airbags and anti-lock brakes.

Honda Genuine accessories are recommended to ensure proper operation on your vehicle.

Handling the Unexpected

This chapter explains how to handle unexpected troubles.

Tools

Types of Tools 674

If a Tyre Goes Flat

Changing a Flat Tyre* 675

Temporarily Repairing a Flat Tyre* 683

Engine Does Not Start

Checking the Engine 692

If the Keyless Remote Battery is Weak.....693

Emergency Engine Stop 694

Jump Starting..... 695

Shift Lever Does Not Move 698

Overheating 699

Indicator, Coming On/Blinking

If the Low Oil Pressure Indicator Comes On 702

If the Charging System Indicator Comes On 702

If the Malfunction Indicator Lamp Comes On or Blinks 703

If the Brake System Indicator (Red) Comes On or Blinks 704

If the Brake System Indicator (Red) comes on or blinks at the same time when the Brake System Indicator (Amber) comes on..... 705

If the Electric Power Steering (EPS) System Indicator Comes On 706

If the Low Tyre Pressure/Deflation Warning System Indicator* Comes On or Blinks ...708

If the Low Oil Level Symbol Appears* ...709

If the Low Oil Level Indicator Comes On* 709

Fuses

Fuse Locations 710

Inspecting and Changing Fuses..... 716

Emergency Towing..... 717

When You Cannot Unlock the Fuel Fill

Door..... 719

When You Cannot Open the Boot .. 720

Refueling..... 721

* Not available on all models

Types of Tools

Types of Tools

The tools were stored in the boot.

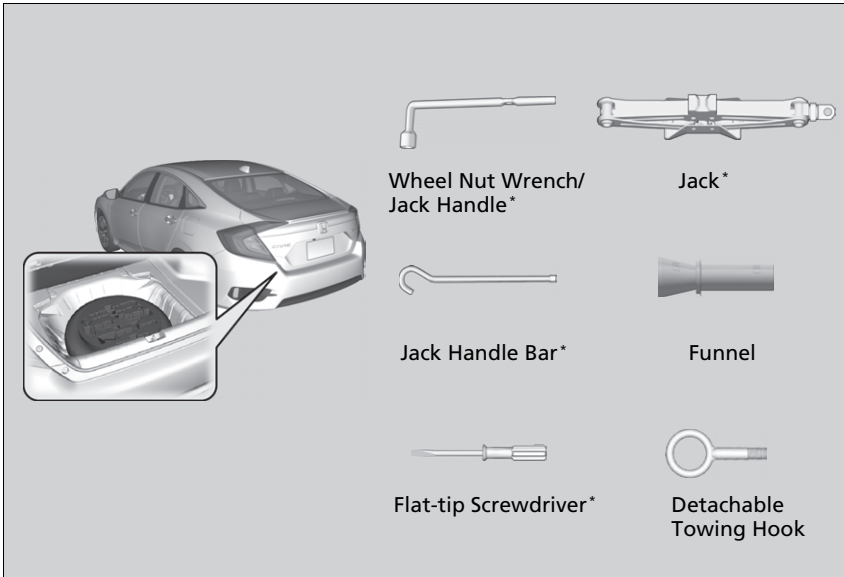

Changing a Flat Tyre *

If a tyre goes flat while driving, grasp the steering wheel firmly, and brake gradually to reduce speed. Then, stop in a safe place. Replace the flat tyre with a compact spare tyre*/full-size spare tyre*. Go to a dealer as soon as possible to have the full-size tyre repaired or replaced.

1. Park the vehicle on firm, level, and non-slippery surface and apply the parking brake.

Continuously variable transmission models

2. Move the shift lever in **P**.

Manual transmission models

2. Move the shift lever in **R**.

All models

3. Turn on the hazard warning lights and turn the ignition switch to LOCK **0***¹.

*1: Models with the keyless access system have an **ENGINE START/STOP** button instead of an ignition switch.

* Not available on all models

Changing a Flat Tyre *

Follow compact spare precautions:
Periodically check the tyre pressure of the compact spare*. It should be set to the specified pressure.
Specified Pressure: 420 kPa (4.2 kgf/cm², 60 psi)

When driving with the compact spare tyre, keep the vehicle speed under 80 km/h. Replace with a full-size tyre as soon as possible.

The compact spare tyre and wheel in your vehicle are specifically for this model. Do not use them with another vehicle. Do not use another type of compact spare tyre or wheel with your vehicle.

Do not mount tyre chains on a compact spare tyre. If a chain-mounted front tyre goes flat, remove one of the full-size rear tyres and replace it with the compact spare tyre. Remove the flat front tyre and replace it with the full-size tyre that was removed from the rear. Mount the tyre chains on the front tyre.

A compact spare tyre gives a harsher ride and less traction on some road surfaces. Use greater caution while driving. Do not mount the compact spare* on the front. If mounted on the front, the compact spare, smaller in size than the full-size tyre, may damage the differential.

Do not use more than one compact spare tyre at the same time.

The compact spare tyre is smaller than the regular tyre. Your vehicle's ground clearance reduces when the compact spare tyre is installed. Driving over road debris or bumps could possibly damage the underside of your vehicle.

Continued

■ Getting Ready to Replace the Flat Tyre

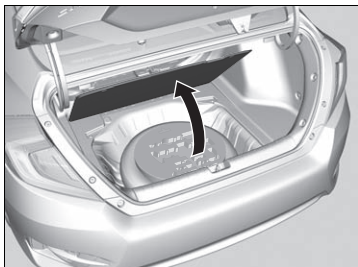

1. Open the boot floor lid.

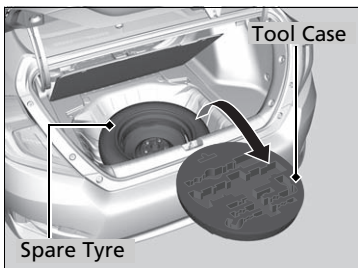

2. Take the tool case out of the boot. Take the jack and wheel nut wrench out of the tool case.

3. Unscrew the wing bolt, and remove the spacer cone. Then, remove the spare tyre.

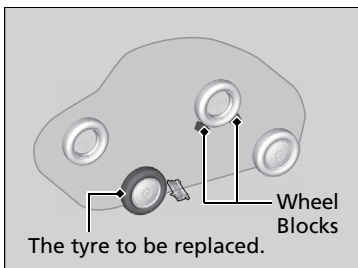

4. Place a wheel block or rock in front and rear of the wheel diagonal to the flat tyre.

✘ Getting Ready to Replace the Flat Tyre

WARNING: The jack can only be used for helping an emergency vehicle breakdown, not for changing the regular seasonal tyre or any other normal maintenance or repair operation.

NOTICE

Do not use the jack if it doesn't work properly. Call your dealer or a professional towing service.



5. Place the spare tyre (wheel side up) under the vehicle body, near the tyre that needs to be replaced.

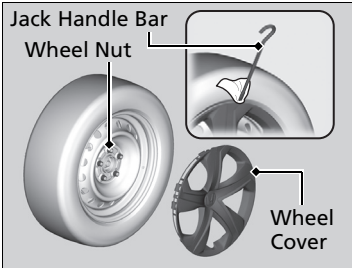

Models with wheel cover

6. Put the flat tip of the jack handle bar into the edge of the wheel cover. Carefully pry the edge and remove the cover.
 - ▶ Wrap a cloth around the flat tip of the jack handle bar to prevent scratches on the cover.



All models

7. Loosen each wheel nut about one turn using the wheel nut wrench.

■ How to Set Up the Jack

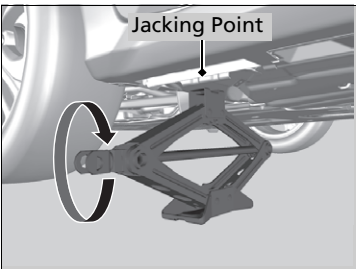
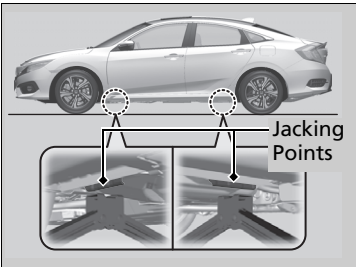

1. Place the jack under the jacking point closest to the tyre to be changed.

2. Turn the end bracket clockwise as shown in the image until the top of the jack contacts the jacking point.

▶ Make sure that the jacking point tab is resting in the jack notch.

▶▶ How to Set Up the Jack

⚠ WARNING

The vehicle can easily roll off the jack, seriously injuring anyone underneath.

Follow the directions for changing a tyre exactly, and no person should place any portion of their body under a vehicle that is supported by a jack.

WARNING: The jack shall be placed on a flat and stable surface on the same level as the vehicle is parked.

For some countries

The jack that came with your vehicle has the following label.

1.	2.	3.

1. See Owner's Manual.
2. Never get under vehicle when supported by jack.
3. Place jack underneath reinforced area.

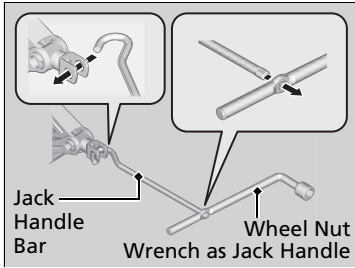

3. Raise the vehicle, using the jack handle bar and the jack handle, until the tyre is off the ground.

Do not use the jack with people or luggage in the vehicle.

Use the jack provided in your vehicle. Other jacks may not support the weight ("load") or their shape may not match.

The following instructions must be followed to use the jack safely:

- Do not use while the engine is running.
- Use only where the ground is firm and level.
- Use only at the jacking points.
- Do not get in the vehicle while using the jack.
- Do not put anything on top of or underneath the jack.

■ Replacing the Flat Tyre

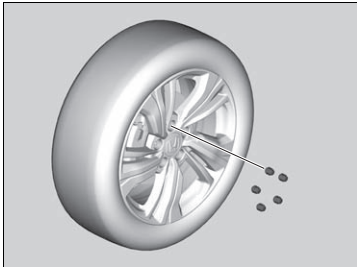

1. Remove the wheel nuts and flat tyre.

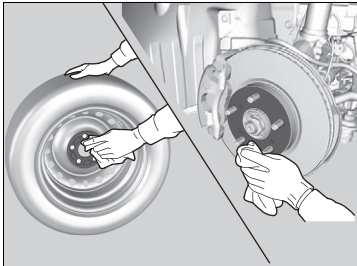

2. Wipe the mounting surfaces of the wheel with a clean cloth.

3. Mount the spare tyre.

4. Screw the wheel nuts until they touch the lips around the mounting holes, then stop rotating.

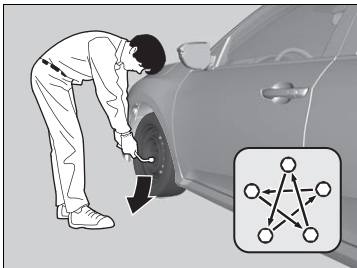

5. Lower the vehicle and remove the jack. Tighten the wheel nuts in the order indicated in the image. Go around, tightening the nuts, two to three times in this order.

Wheel nut torque:

108 N·m (11 kgf·m, 80 lbf·ft)

▶▶ Replacing the Flat Tyre

Do not over tighten the wheel nuts by applying extra torque using your foot or a pipe.

Models with wheel cover

Make sure the wire support ring is hooked into the clips around the edge of the wheel cover.

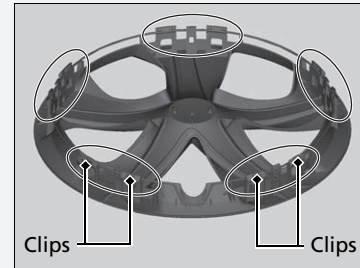

Align the valve mark on the wheel cover to the tyre valve on the wheel, then install the wheel cover.

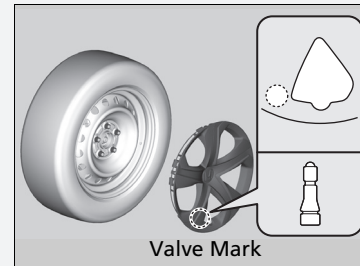

Storing the Flat Tyre

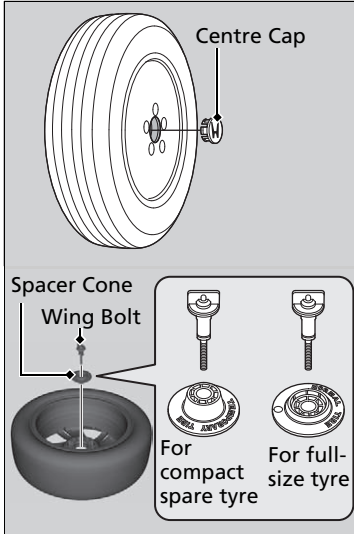

Models with aluminium wheels

1. Remove the centre cap.

All models

2. Place the flat tyre face down in the spare tyre well.
3. Remove the spacer cone from the wing bolt, flip it over, and insert it back on the bolt. Secure the flat tyre with the wing bolt.
4. Securely put the jack and wheel nut wrench back in the tool case. Store the case in the boot.

Replacing the Flat Tyre

Models with wheel cover

Make sure the wire support ring is on the outer side of the tyre valve as shown.

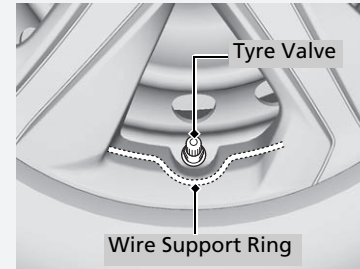



Storing the Flat Tyre

⚠ WARNING

Loose items can fly around the interior in a crash and can seriously injure the occupants.
Store the wheel, jack, and tools securely before driving.

■ Deflation Warning System and the Spare Tyre*

If you replace a flat tyre with the spare tyre, the  indicator comes on while you are driving. After driving for a few kilometers, the indicator will start blinking for a short time and then stay on.  appears on the driver information interface*, but this is normal.

Calibrate the deflation warning system when you replace the tyre with a specified regular tyre.

➤ **Deflation Warning System Calibration** P. 556

Temporarily Repairing a Flat Tyre*

If the tyre has a large cut or is otherwise severely damaged, you will need to have the vehicle towed. If the tyre only has a small puncture, from a nail for instance, you can use the temporary tyre repair kit so that you can drive to the nearest service station for a more permanent repair.

If a tyre goes flat while driving, grasp the steering wheel firmly, and brake gradually to reduce speed. Then stop in a safe place.

1. Park the vehicle on firm, level, and non-slippery surface and apply the parking brake.

Continuously variable transmission models

2. Change the gear position to **P**.

Manual transmission models

2. Move the shift lever to **R**.

All models

3. Turn on the hazard warning lights and turn the ignition switch to LOCK **0***1.
 - ▶ When towing a trailer, unhitch the trailer.

*1: Models with the keyless access system have an **ENGINE START/STOP** button instead of an ignition switch.

* Not available on all models

Continued

Temporarily Repairing a Flat Tyre*

The kit should not be used in the following situations. Instead, contact a dealer or roadside assistant to have the vehicle towed.

- The tyre sealant has expired.
- More than one tyre is punctured.
- The puncture or cut is larger than 4 mm.
- The tyre side wall is damaged or the puncture is outside the tyre area.

	When the puncture is:	Kit Use
	Smaller than 4 mm	Yes
	Larger than 4 mm	No

- Damage has been caused by driving with the tyres extremely under inflated.
- The tyre bead is no longer seated.
- The rim is damaged.

Do not remove a nail or screw that punctured the tyre. If you remove it from the tyre, you may not be able to repair the puncture using the kit.

■ Getting Ready to Temporarily Repair the Flat Tyre

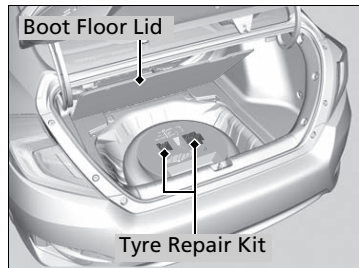
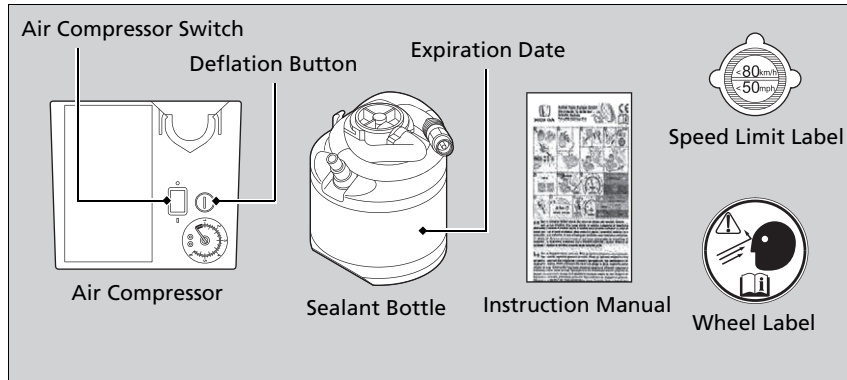

1. Open the boot floor lid.
2. Take the kit out of the tool case.
3. Place the kit, face up, on flat ground near the flat tyre, away from traffic. Do not place the kit on its side.

▣ Getting Ready to Temporarily Repair the Flat Tyre

When making a temporary repair, carefully read the instruction manual provided with the kit.

Injecting Sealant and Air

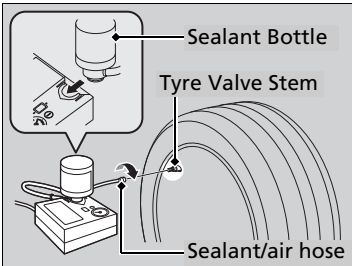
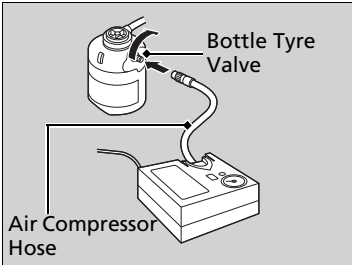
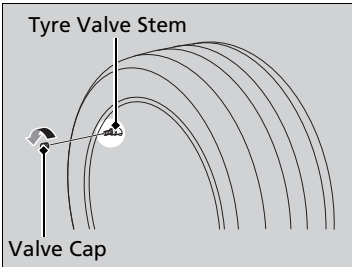

1. Remove the valve cap from the tyre valve stem.
2. Shake the sealant bottle.
3. Attach the air compressor hose onto the bottle tyre valve. Screw it until it is tight.
4. Upside down the sealant bottle, then attach the bottle into the cutout of the air compressor.
5. Attach the sealant/air hose onto the tyre valve stem. Screw it until it is tight.

Injecting Sealant and Air

⚠ WARNING

Tyre sealant contains substances that are harmful and can be fatal if swallowed.

If accidentally swallowed, do not induce vomiting. Drink plenty of water and get medical attention immediately.

For skin or eye contact, flush with cool water and get medical attention if necessary.

Keep the sealant bottle out of the reach of children.

In cold temperatures, the sealant may not flow easily. In this situation, warm it up for five minutes before using.

The sealant is latex based and can permanently stain clothing and other materials. Be careful during handling and wipe up any spills immediately.

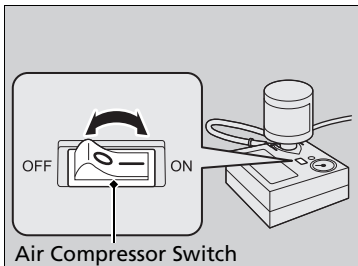
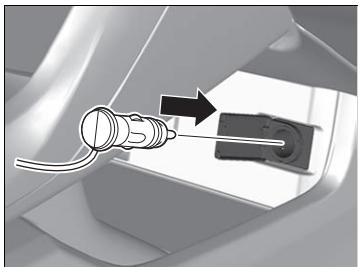

6. Plug in the compressor to the accessory power socket.
 - ▶ Be careful not to pinch the cord in a door or window.
 - ✦ **Accessory Power Socket** P. 237
7. Turn the ignition switch to START *1 without depressing the accelerator pedal, then start the engine.
 - ✦ **Carbon Monoxide Gas** P. 90
8. Turn the air compressor on to inflate the tyre.
 - ▶ The compressor starts injecting sealant and air into the tyre.
9. After the air pressure reaches to specified pressure, turn off the kit.
 - ▶ Check the air pressure gauge on the air compressor.
 - ▶ Refer to the driver's doorjamb label for the specified pressure.

*1: Models with the keyless access system have an **ENGINE START/STOP** button instead of an ignition switch.

✦ Injecting Sealant and Air

WARNING

Running the engine with the vehicle in an enclosed or even partly enclosed area can cause a rapid build-up of toxic carbon monoxide. Breathing this colourless, odourless gas can cause unconsciousness and even death. Only run the engine to power the air compressor with the vehicle outdoors.

NOTICE

Do not operate the temporary tyre repair kit compressor for more than 15 minutes. The compressor can overheat and become permanently damaged.

Until the sealant injection is complete, the pressure shown on the pressure gauge will appear higher than actual. After the sealant injection is complete the pressure will drop and then begin to rise again as the tyre is inflated with air. This is normal. To accurately measure the air pressure using the gauge, turn the air compressor off only after the sealant injection is complete.

If the required air pressure is not reached within 10 minutes, the tyre may be too severely damaged for the kit to provide the necessary seal and your vehicle will need to be towed.

See a Honda dealer for a replacement sealant bottle and proper disposal of an empty bottle.

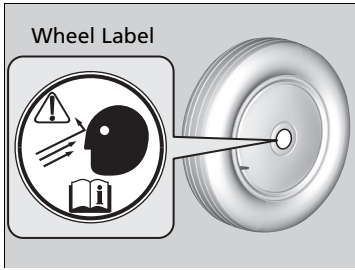

10. Unplug the kit from the accessory power socket.
11. Unscrew the sealant/air hose from the tyre valve stem. Reinstall the valve cap.
12. Apply the wheel label to the flat surface of the wheel.
 - ▶ The wheel surface must be clean to ensure the label adheres properly.

■ Distributing the Sealant in the Tyre

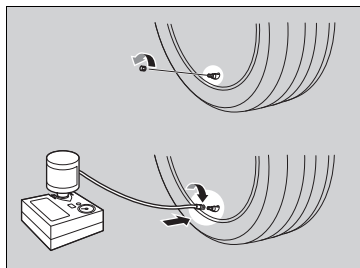
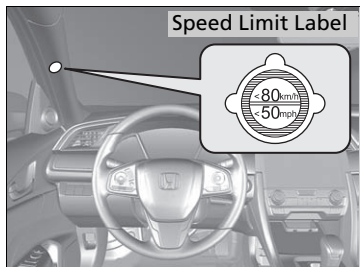

1. Apply the speed limit label to the location as shown.
2. Drive the vehicle for about 10 minutes.
 - ▶ Do not exceed 80 km/h.
3. Stop the vehicle in a safe place.
4. Recheck the air pressure using the gauge on the air compressor.
 - ▶ Do not turn the air compressor on to check the pressure.
5. If the air pressure is:
 - Less than 130 kPa (19 psi):
Do not add air or continue driving. The leak is too severe. Call for help and have your vehicle towed.
 - ☒ **Emergency Towing** P. 717
 - Specified pressure more:
Continue driving for another 10 minutes or until you reach the nearest service station. Do not exceed 80 km/h.
 - ▶ If the air pressure does not go down after the 10 minute driving, you do not need to check the pressure any more.

☒ Distributing the Sealant in the Tyre

Stop and recheck the air pressure after every 10 minutes of driving as necessary until you reach the nearest service station where you should have the tyre permanently repaired or replaced.

Refer to the driver's doorjamb label for the specified pressure.

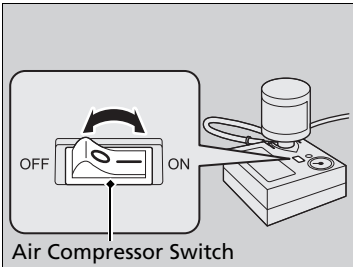
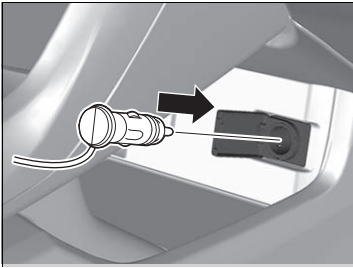

- Greater than 130 kPa (19 psi), but less than specified pressure:
Turn the air compressor switch on to inflate the tyre until the tyre pressure reaches specified pressure.

► **Injecting Sealant and Air** P. 685

Then drive carefully for 10 more minutes or until you reach the nearest service station. Do not exceed 80 km/h.

- You should repeat this procedure as long as the air pressure is within this range.

6. Repackage and properly stow the kit.

► Distributing the Sealant in the Tyre

Refer to the driver's doorjamb label for the specified pressure.

■ Inflating An Under-inflated Tyre

You can use the kit to inflate a non-punctured under-inflated tyre.

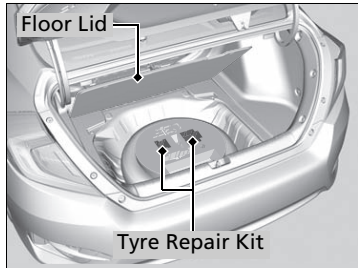

1. Open the boot floor lid.
2. Remove the kit from the case.
3. Place the kit, face up, on flat ground near the flat tyre, away from traffic. Do not place the kit on its side.

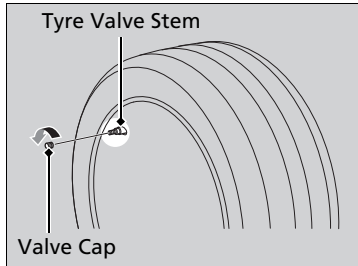

4. Remove the valve cap.

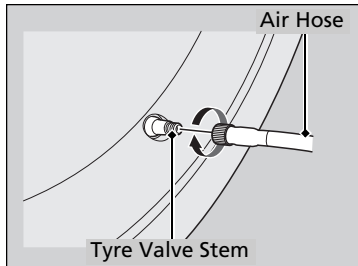



5. Attach the air hose onto the tyre valve stem. Screw it until it is tight.

▶▶ Inflating An Under-inflated Tyre

NOTICE

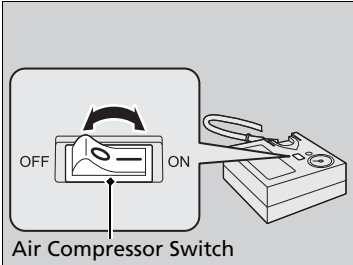
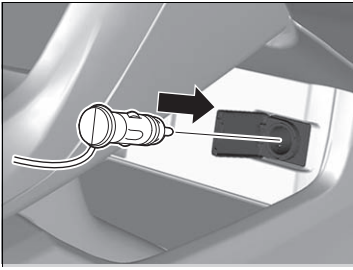
Do not operate the temporary tyre repair kit compressor for more than 15 minutes. The compressor can overheat and become permanently damaged.



6. Plug in the compressor to the accessory power socket.
 - ▶ Be careful not to pinch the cord in a door or window.
 - **Accessory Power Socket** P. 237
7. Turn the ignition switch to START *1 without depressing the accelerator pedal, then start the engine.
 - **Carbon Monoxide Gas** P. 90
8. Turn the air compressor switch on to inflate the tyre.
 - ▶ The compressor starts to inject air into the tyre.
 - ▶ If you have started the engine, leave it running while injecting air.
9. Inflate the tyre to the specified air pressure.
10. Turn off the kit.
 - ▶ Check the pressure gauge on the air compressor.
 - ▶ If overinflated, press the deflate button.
11. Unplug the kit from the accessory power socket.
12. Unscrew the air hose from the tyre valve stem. Reinstall the valve cap.
13. Repackage and properly stow the kit.

▶▶ Inflating An Under-inflated Tyre

⚠ WARNING

Running the engine with the vehicle in an enclosed or even partly enclosed area can cause a rapid build-up of toxic carbon monoxide. Breathing this colourless, odourless gas can cause unconsciousness and even death. Only run the engine to power the air compressor with the vehicle outdoors.

*1: Models with the keyless access system have an **ENGINE START/STOP** button instead of an ignition switch.

Checking the Engine

If the engine does not start, check the starter.

☒ Checking the Engine

If you must start the vehicle immediately, use an assisting vehicle or booster battery to jump start it.

☒ **Jump Starting** P. 695

Do not hold the **ENGINE START/STOP** button* for more than 15 seconds.

Starter condition

Checklist

Starter doesn't turn or turns over slowly.

The battery may be dead. Check each of the items on the right and respond accordingly.

Models with keyless access system

Check for a message on the driver information interface*.

- If the **To Start, Hold Remote Near Start Button** message appears
 - ☒ **If the Keyless Remote Battery is Weak** P. 693
- ▶ Make sure the keyless remote is in its operating range
 - ☒ **ENGINE START/STOP Button Operating Range** P. 198

Check brightness of the interior lights.

Turn on the interior lights and check the brightness.

- If the interior lights are dim or do not come on at all
 - ☒ **Battery** P. 656
- If the interior lights come on normally ☒ **Fuses** P. 710

The starter turns over normally but the engine doesn't start.

There may be a problem with the fuse. Check each of the items on the right and respond accordingly.

Review the engine start procedure.

Follow its instructions, and try to start the engine again. ☒ **Starting the Engine** P. 458, 461

Check the immobilizer system indicator.

When the immobilizer system indicator is blinking, the engine cannot be started.

☒ **Immobilizer System** P. 189

Check the fuel level.

There should be enough fuel in the tank. ☒ **Fuel Gauge** P. 151

Check the fuse.

Check all fuses, or have your vehicle checked by a dealer.

☒ **Inspecting and Changing Fuses** P. 716

If the problem continues:

☒ **Emergency Towing** P. 717

Model with keyless access system

If the Keyless Remote Battery is Weak

If the beeper sounds, the **To Start, Hold Remote Near Start Button** message appears on the driver information interface, and the **ENGINE START/STOP** button flashes, and the engine won't start, start the engine as follows.

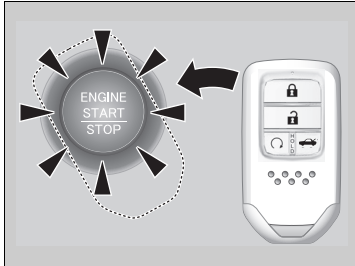

1. Touch the centre of the **ENGINE START/STOP** button with the **H** logo on the keyless remote while the **ENGINE START/STOP** button is flashing. The buttons on the keyless remote should be facing you.
 - ▶ The **ENGINE START/STOP** button flashes for about 30 seconds.

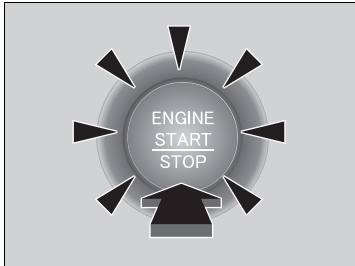

2. Depress the brake pedal (Continuously variable transmission) or clutch pedal (manual transmission) and press the **ENGINE START/STOP** button within 10 seconds after the beeper sounds and the **ENGINE START/STOP** button changes from flashing to on.
 - ▶ If you do not depress the pedal, the mode changes to ACCESSORY.

Model with keyless access system

Emergency Engine Stop

The **ENGINE START/STOP** button may be used to stop the engine due to an emergency situation even while driving. If you must stop the engine, do either of the following operations:

- Press and hold the **ENGINE START/STOP** button for about three seconds.
- Firmly press the **ENGINE START/STOP** button twice.

The steering wheel will not lock.

Continuously variable transmission models

The power mode is in ACCESSORY when the engine is stopped.

To change the mode to VEHICLE OFF (LOCK), move the shift lever to **P** after the vehicle comes to a complete stop. Then press the **ENGINE START/STOP** button twice without depressing the brake pedal.

Manual transmission models

The power mode changes to VEHICLE OFF (LOCK).

» Emergency Engine Stop

Do not press the button while driving unless it is absolutely necessary for the engine to be turned off.

Jump Starting Procedure

Turn off the power to electric devices, such as audio and lights. Turn off the engine, then open the bonnet.

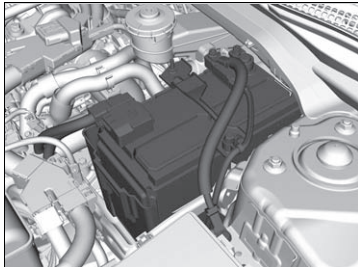

1. Open the fuse box cover on your vehicle's battery positive \oplus terminal.
2. Connect the first jumper cable to your vehicle's battery \oplus terminal.
3. Connect the other end of the first jumper cable to the booster battery \oplus terminal.
 - ▶ Use a 12-volt booster battery only.
 - ▶ When using an automotive battery charger to boost your 12-volt battery, select a lower charging voltage than 15-volt. Check the charger manual for the proper setting.
4. Connect the second jumper cable to the booster battery \ominus terminal.

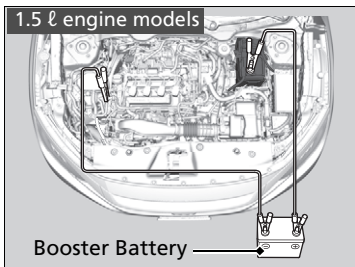

Jump Starting

⚠ WARNING

A battery can explode if you do not follow the correct procedure, seriously injuring anyone nearby.

Keep all sparks, open flames, and smoking materials away from the battery.

NOTICE

If a battery sits in extreme cold, the electrolyte inside can freeze. Attempting to jump start with a frozen battery can cause it to rupture.

Securely attach the jumper cables clips so that they do not come off when the engine vibrates. Also be careful not to tangle the jumper cables or allow the cable ends to touch each other while attaching or detaching the jumper cables.

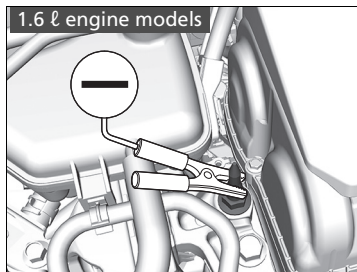
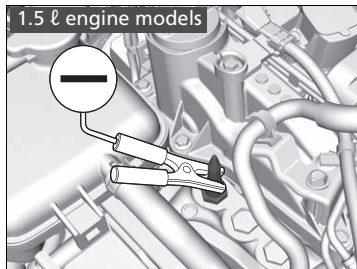
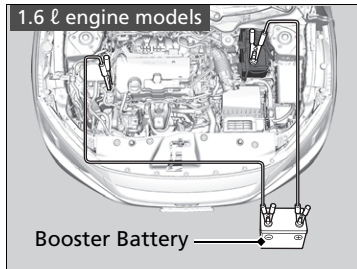

5. Connect the other end of the second jumper cable to the engine mounting bolt as shown. Do not connect this jumper cable to any other part.
6. If the jumper cable is connected to another vehicle, start the assisting vehicle's engine and increase engine's revolution slightly.
7. Attempt to start your vehicle's engine. If it turns over slowly, check that the jumper cables have good metal-to-metal contact.

▶▶ Jump Starting

Battery performance degrades in cold conditions and may prevent the engine from starting.

■ What to Do After the Engine Starts

Once your vehicle's engine has started, remove the jumper cables in the following order.

1. Disconnect the jumper cable from your vehicle's ground.
2. Disconnect the other end of the jumper cable from the booster battery \ominus terminal.
3. Disconnect the jumper cable from your vehicle's battery \oplus terminal.
4. Disconnect the other end of the jumper cable from the booster battery \oplus terminal.

Have your vehicle inspected by a nearby service station or a dealer.

Shift Lever Does Not Move

Continuously variable transmission models

Follow the procedure below if you cannot move the shift lever out of the **P** position.

Releasing the Lock

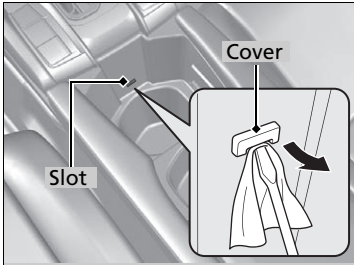

1. Set the parking brake.

Models without keyless access system

2. Remove the key from the ignition switch.

Models with keyless access system

2. Remove the built-in key from the keyless remote.

All models

3. Move the armrest rearward.

4. Wrap a cloth around the tip of a small flat-tip screwdriver. Put it into the shift lock release slot as shown in the image, and remove the cover.

5. Insert the key into the shift lock release slot.

6. While pushing the key down, press the shift lever release button and place the shift lever into **N**.

► The lock is now released. Have the shift lever checked by a dealer as soon as possible.

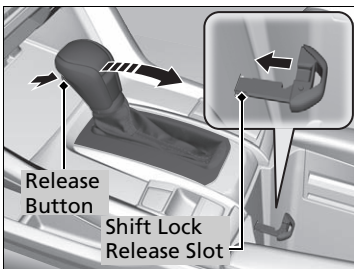

How to Handle Overheating

Overheating symptoms are as follows:

- The temperature gauge pointer is at the **H** mark*¹ or upper level*² or the engine suddenly loses power.
- **Stop Driving When Safe. Engine Temperature Too Hot** message appears on the driver information interface.*
- Steam or spray is comes out of the engine compartment.

■ First thing to do

1. The Immediately park the vehicle in a safe place.
2. The Turn off all accessories and turn on the hazard warning lights.
 - ▶ **No steam or spray present:** Keep the engine running and open the bonnet.
 - ▶ **Steam or spray is present:** Turn off the engine and wait until it subsides. Then open the bonnet.

*1: Middle Eastern except Israeli and Turkish models

*2: Israeli, Turkish, and except Middle Eastern models

* Not available on all models

☒ How to Handle Overheating

⚠ WARNING

Steam and spray from an overheated engine can seriously scald you.

Do not open the bonnet if steam is coming out.

NOTICE

Continuing to drive with the temperature gauge pointer at the **H** mark*¹ or upper level*² may damage the engine.

■ Next thing to do

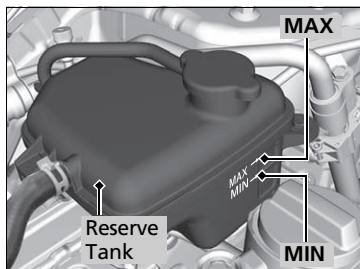

1. Check that the cooling fan is operating and stop the engine once the high temperature gauge pointer comes down.
 - If the cooling fan is not operating, immediately stop the engine.
2. Once the engine has cooled down, inspect the coolant level and check the cooling system components for leaks.
 - If the coolant level in the reserve tank is low, add coolant until it reaches the **MAX** mark.
 - If there is no coolant in the reserve tank, check that the radiator is cool. Cover the reserve tank cap with a heavy cloth and open the cap. If necessary, add coolant up to the base of the filler neck, and put the cap back on.

■ Last thing to do

Once the engine has cooled sufficiently, restart it and check the temperature gauge. If the temperature gauge pointer has gone down, resume driving. If it has not gone down, contact a dealer for repairs.

►► How to Handle Overheating

⚠ WARNING

Removing the reserve tank cap while the engine is hot can cause the coolant to spray out, seriously scalding you.

Always let the engine and radiator cool down before removing the reserve tank cap.

If the coolant is leaking, contact a dealer for repairs.

Use water as an emergency/temporary measure only. Have a dealer flush the system with proper antifreeze as soon as possible.

■ The Stop Driving When Safe. Engine Temperature Too Hot Message Appears On The Driver Information Interface.*

The **Stop Driving When Safe. Engine Temperature Too Hot** message appears on the driver information interface when the engine temperature is high.

📄 **Driver Information Interface Warning and Information Messages*** P. 126

1. Immediately park the vehicle in a safe place.
 - ▶ Move the shift lever to [P], and set the parking brake. Turn off all accessories and turn on the hazard warning lights.
2. Keep the engine running, and wait until the message disappears.
 - ▶ If the message does not disappear, have the vehicle inspected at a dealer.

📄 How to Handle Overheating

Continuing to drive with the **Stop Driving When Safe. Engine Temperature Too Hot** message on the driver information interface may damage the engine.

* Not available on all models

If the Low Oil Pressure Indicator Comes On



■ Reasons for the indicator to come on

Comes on when the engine oil pressure is low.

■ What to do as soon as the indicator comes on

1. Immediately park the vehicle on level ground in a safe place.
2. If necessary, turn the hazard warning lights on.

■ What to do after parking the vehicle

1. Stop the engine and let it sit for about three minutes.
2. Open the bonnet and check the oil level.
 - **Oil Check** P. 624
3. Start the engine and check the low oil pressure indicator.
 - ▶ The light goes out: Start driving again.
 - ▶ The light does not go out within 10 seconds: Stop the engine and contact a dealer for repairs immediately.

If the Charging System Indicator Comes On



■ Reasons for the indicator to come on

Comes on when the battery is not being charged.

■ What to do when the indicator comes on

Turn off the climate control system, rear demister, and other electrical systems, and immediately contact a dealer for repairs.

☒ If the Low Oil Pressure Indicator Comes On

NOTICE

Running the engine with low oil pressure can cause serious mechanical damage almost immediately.

☒ If the Charging System Indicator Comes On

If you need to stop temporarily, do not turn off the engine. Restarting the engine may rapidly discharge the battery.

If the Malfunction Indicator Lamp Comes On or Blinks



■ Reasons for the indicator lamp to come on or blink

- Comes on if there is a problem with the engine emissions control system.
- Blinks when engine misfiring is detected.

■ What to do when the indicator lamp comes on

Avoid high speeds and immediately get your vehicle inspected at a dealer.

■ What to do when the indicator lamp blinks

Park the vehicle in a safe place with no flammable items and wait at least 10 minutes or more with the engine stopped until it cools.

▶▶ If the Malfunction Indicator Lamp Comes On or Blinks

NOTICE

If you drive with the malfunction indicator lamp on, the emissions control system and the engine could be damaged.

If the malfunction indicator lamp blinks again when restarting the engine, drive to the nearest dealer at 50 km/h or less. Have your vehicle inspected.

If the Brake System Indicator (Red) Comes On or Blinks



■ Reasons for the indicator to come on

- The brake fluid is low.
- There is a malfunction in the brake system.

■ What to do when the indicator comes on while driving

Press the brake pedal lightly to check pedal pressure.

- If normal, check the brake fluid level the next time you stop.
- If abnormal, take immediate action. If necessary, downshift the transmission to slow the vehicle using engine braking.

■ Reasons for the indicator to blink

- There is a problem with the electric parking brake system.

■ What to do when the indicator blinks

- Avoid using the parking brake and have your vehicle checked by a dealer immediately.

☒ If the Brake System Indicator (Red) Comes On or Blinks

Have your vehicle repaired immediately.

It is dangerous to drive with low brake fluid. If there is no resistance from the brake pedal, stop immediately in a safe place. If necessary downshift the gears.

If the brake system indicator and **ABS** indicator come on simultaneously, the electronic brake distribution system is not working. This can result in vehicle instability under sudden braking.

Have your vehicle inspected by a dealer immediately.

If the Brake System Indicator (Red) blinks at the same time when the Brake System Indicator (Amber) comes on, the parking brake may not work.

Avoid using the parking brake and have your vehicle checked by a dealer immediately.

☒ If the Brake System Indicator (Red) comes on or blinks at the same time when the Brake System Indicator (Amber) comes on

P. 705

If you repeatedly operate the electric parking brake in a short period of time, the brake stops operating to prevent heating of the system and the indicator blinks.

It returns to its original state in approximately 1 minute.

If the Brake System Indicator (Red) comes on or blinks at the same time when the Brake System Indicator (Amber) comes on



(Red)



(Amber)

■ **If the Brake System Indicator (Red) comes on or blinks at the same time when the Brake System Indicator (Amber) comes on, release the parking brake manually or automatically**

➤ **Parking Brake** P. 560

- If the Brake System Indicator (Red) continuously comes on or blinks at the same time when the Brake System Indicator (Amber) comes on, stop the vehicle in a safe place and have it inspected by a dealer immediately.

➤ **Preventing the vehicle from moving**

Continuously variable transmission models

Move to shift lever to **P**.

Manual transmission models

Move to shift lever to **1** or **R**.

- If only the Brake System Indicator (Red) is turned off, avoid using the parking brake and have your vehicle checked by a dealer immediately.

⚠ If the Brake System Indicator (Red) comes on or blinks at the same time when the Brake System Indicator (Amber) comes on

If you apply the parking brake, you may not be able to release it.

If the Brake System Indicator (Red) and the Brake System Indicator (Amber) come on at the same time, the parking brake is working.

If the Brake System Indicator (Red) blinks at the same time when the Brake System Indicator (Amber) comes on, the parking brake may not work because it is checking the system.

If the Electric Power Steering (EPS) System Indicator Comes On



■ Reasons for the indicator to come on

- Comes on if there is a problem with the EPS system.
- If you depress the accelerator pedal repeatedly to increase the engine speed while the engine is idling, the indicator comes on, and sometimes the steering wheel becomes harder to operate.
- Comes on when EPS steering angle centre point memory is lost. This could be due to a number of problems to include: battery disconnect, main fuse blow, low battery causing reset of the EPS system, wire damage to EPS harness. Vehicle Stability Assist (VSA), VSA OFF, and low tyre pressure/deflation warning system* indicators also come on with EPS indicator.

Models with driver information interface

The **Drive Carefully Systems Initializing...** message appears on the driver information interface.

■ **What to do when the indicator comes on**

- Stop the vehicle in a safe place and restart the engine.
If the indicator comes on and stays on, immediately have your vehicle inspected by a dealer.
- If the EPS indicator, VSA indicator, VSA OFF indicator, and low tyre pressure/deflation warning system* indicator come on simultaneously, you need to calibrate the VSA and EPS systems.
Drive a short distance at more than 20 km/h to calibrate the VSA and EPS systems.
If the indicators come on and stay on, park your vehicle in a safe place, turn off and restart the engine, then repeat the above operation.
If the indicators still come on and stay on, immediately have your vehicle inspected by a dealer.

* Not available on all models

If the Low Tyre Pressure/Deflation Warning System Indicator* Comes On or Blinks



■ Reasons for the indicator to come on/blink

A tyre pressure is significantly low, or the deflation warning system has not been calibrated. If there is a problem with the deflation warning system or the compact spare tyre* is installed, the indicator blinks for about one minute, and then stays on.

■ What to do when the indicator comes on

Drive carefully and avoid abrupt cornering and hard braking.

Stop your vehicle in a safe place. Check the tyre pressure and adjust the pressure to the specified level. The specified tyre pressure is on a label on the driver side doorjamb.

- ▶ Calibrate the deflation warning system after the tyre pressure is adjusted.

➤ **Deflation Warning System Calibration** P. 556

■ What to do when the indicator blinks, then remains on

Have the tyre inspected by a dealer as soon as possible. If the compact spare tyre* causes the indicator to blink, change the tyre to a full-size tyre.

The indicator goes off after driving for a few kilometres.

- ▶ Calibrate the deflation warning system after a full-size tyre is reinstalled.

➤ **Deflation Warning System Calibration** P. 556

⚠ If the Low Tyre Pressure/Deflation Warning System Indicator* Comes On or Blinks

NOTICE

Driving on an extremely underinflated tyre can cause it to overheat. An overheated tyre can fail. Always inflate your tyres to the prescribed level.

If the Low Oil Level Symbol Appears*



■ Reasons for the symbol to appear

Appears when the engine oil level is low.

■ What to do as soon as the symbol appears

1. Immediately park the vehicle on level ground in a safe place.
2. If necessary, turn the hazard warning lights on.

■ What to do after parking the vehicle

1. Stop the engine and let it sit for about three minutes.
2. Open the bonnet and check the oil level.

🔧 **Oil Check** P. 624

If the Low Oil Level Indicator Comes On*



■ Reasons for the symbol to come on

Comes on when the engine oil level is low.

■ What to do as soon as the indicator comes on

1. Immediately park the vehicle on level ground in a safe place.
2. If necessary, turn the hazard warning lights on.

■ What to do after parking the vehicle

1. Stop the engine and let it sit for about three minutes.
2. Open the bonnet and check the oil level.

🔧 **Oil Check** P. 624

▶▶ If the Low Oil Level Symbol Appears*

NOTICE

Running the engine with low oil level can cause serious mechanical damage almost immediately.

This system activates after the engine warms up. If the outside temperature is extremely low, you may have to drive for a long time until the system senses the engine oil level.

If the indicator appears again, stop the engine and contact a dealer for repairs immediately.

▶▶ If the Low Oil Level Indicator Comes On*

NOTICE

Running the engine with low oil level can cause serious mechanical damage almost immediately.

This system activates after the engine warms up. If the outside temperature is extremely low, you may have to drive for a long time until the system senses the engine oil level.

If the indicator comes on again, stop the engine and contact a dealer for repairs immediately.

Fuse Locations

If any electrical devices are not working, turn the ignition switch to LOCK \square *1 and check to see if any applicable fuse is blown.

Engine Compartment Fuse Box

Models without fuse label

Located near battery. Push the tabs to open the box.

Fuse locations are shown on the image below.

Locate the fuse in question by the fuse number in the image and chart.

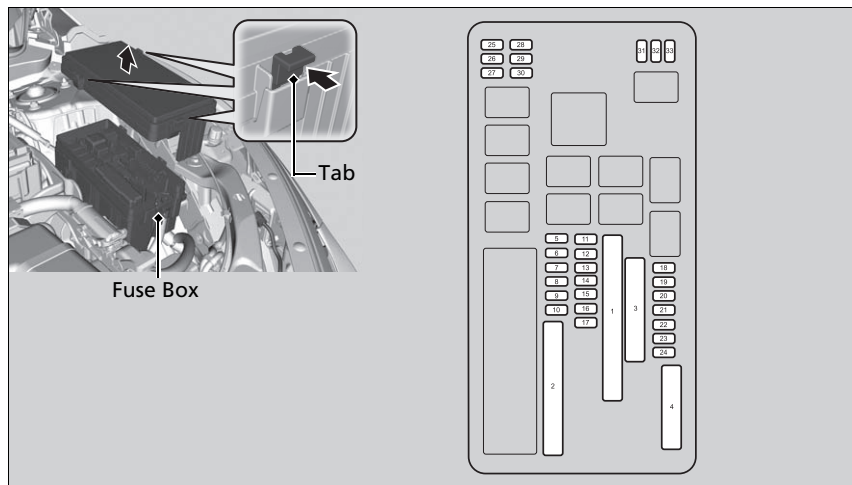

*1: Models with the keyless access system have an **ENGINE START/STOP** button instead of an ignition switch.

■ Circuit protected and fuse rating

	Circuit Protected	Amps
1	–	(60 A)
	–	(30 A)
	Cooling Fan	(30 A)
	Premium Amp	(30 A)
	IG Main	(30 A)
	Headlight High Beam Main	30 A
	Battery	(100 A)
2	EPS	70 A
	IG Main	30 A* ¹ 50 A* ²
	Fuse Box Option	(40 A)
	Fuse Box	60 A
	Front Wiper Motor	30 A
3	Headlight Low Beam Main	30 A
	Rear Defroster	40 A
	Starter Motor	(30 A)
	Fuse Box	40 A
	ABS/VSA Motor	40 A
	ABS/VSA FSR	40 A
4	Blower Motor	40 A
	–	–
	–	–
	–	–
5	Cooling Fan	(5 A)

	Circuit Protected	Amps
6	Washer	15 A
7	FI Main	15 A
8	Stop Lights	10 A
9	FI Sub	15 A
10	Injector	15 A
11	LAF	5 A
12	FI ECU	10 A
13	Hazard	15 A
14	Rear Heated Seat	(15 A)
15	IG Coil	(15 A)
16	Transmission* ³	(15 A)
17	Daytime Running Lights	(10 A)
18	Back Up	10 A
19	Audio	(15 A)
20	Position Lights	10 A
21	Interior Lights	10 A
22	Front Fog Lights	(15 A)
23	A/C Compressor	(10 A)
24	Horn	10 A
25	Audio	10 A
26	Left Headlight Low Beam	10 A
27	Right Headlight Low Beam	10 A
28	Back Up 2	(5 A)
29	Left Headlight High Beam	10 A
30	Right Headlight High Beam	10 A
31	–	–
32	Headlight Washer	(30 A)

	Circuit Protected	Amps
33	VB ACT	(5 A)

*1: Models with keyless access system
 *2: Models without keyless access system
 *3: Continuously variable transmission models

Models with fuse label

Fuse locations are shown on the fuse box cover.

Locate the fuse in question by the fuse number and box cover number.

Located near the battery. Push the tabs to open the box.

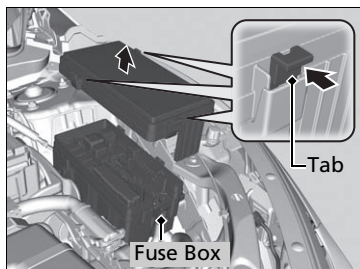

Handling the Unexpected

■ Circuit protected and fuse rating















	Circuit Protected	Amps
1	–	(60 A)
	–	(30 A)
	Cooling Fan	30 A
	Premium Amp	(30 A)
	IG Main	(30 A)
	Headlight High Beam Main	30 A
	Battery	(100 A)
	EPS	70 A
	IG Main	30 A ^{*1} 50 A ^{*2}
	Fuse Box Option *	(40 A)
2	Fuse Box	60 A
	Front Wiper Motor	30 A
	Headlight Low Beam Main	30 A
	Rear Defroster	40 A
	Starter Motor	(30 A)
3	Fuse Box	40 A
	ABS/VSA Motor	40 A
	ABS/VSA FSR	40 A
	Blower Motor	40 A

	Circuit Protected	Amps
4	–	(40 A)
	–	(40 A)
	–	(40 A)
	–	(40 A)
5	Cooling Fan	(5 A)
6	Washer	15 A
7	FI Main	15 A
8	Stop Lights	10 A
9	FI Sub	15 A
10	Injector	(15 A)
11	LAF	(5 A)
12	FI ECU	(10 A)
13	Hazard	15 A
14	Rear Heated Seat	(15 A)
15	IG Coil	15 A
16	Transmission ^{*3}	(15 A)
17	Daytime Running Lights	(10 A)

*1: Models with keyless access system

*2: Models without keyless access system

*3: Continuously variable transmission models

	Circuit Protected	Amps
18	 Back Up	10 A
19	 Audio	(15 A)
20	 Position Lights	10 A
21	 Interior Lights	10 A
22	 Front Fog Lights	(15 A)
23	 A/C Compressor	10 A
24	 Horn	10 A
25	 Audio	(10 A)
26	 Left Headlight Low Beam	10 A
27	 Right Headlight Low Beam	10 A
28	 Back Up 2	(5 A)
29	 Left Headlight High Beam	10 A
30	 Right Headlight High Beam	10 A
31	–	–
32	– Headlight Washer	–
33	 VB ACT	(5 A)

Interior Fuse Box

Models without fuse label

Located under the dashboard.
Fuse locations are shown on the image below.

Locate the fuse in question by the fuse number in the image and chart.

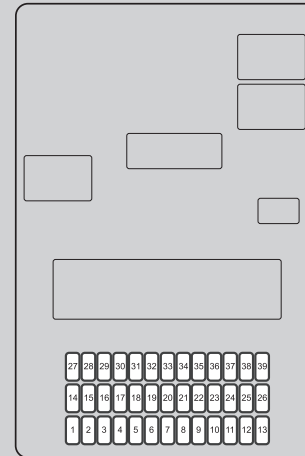
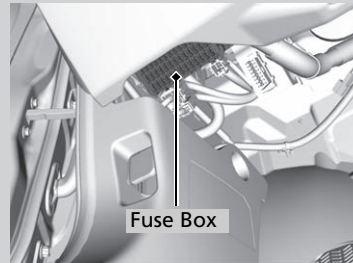

■ Circuit protected and fuse rating

	Circuit Protected	Amps
1	Accessory	10 A
2	Key Lock	(5 A)
3	–	(10 A)
4	Front Sensor Camera* ¹ Transmission* ^{2, *3}	(5 A) (10 A)
5	Option	10 A
6	SRS Indicator	10 A
7	Meter	10 A
8	Fuel Pump	15 A
9	AIRCON	10 A
10	–	(20 A)
11	IG1 Monitor	5 A
12	Right Side Door Lock	10 A
13	Left Side Rear Door Unlock	10 A
14	Rear Left Side Power Window	(20 A)
15	Front Passenger's Side Power Window	20 A
16	Door Lock	20 A
17	Transmission* ^{1, *3} Front Sensor Camera* ²	(10 A) (5 A)
18	–	(10 A)
19	Sunroof*	(20 A)
20	IG1 Starter	(10 A)
21	ACG	10 A
22	Daytime Running Lights	(10 A)
23	Rear Fog Light	10 A

	Circuit Protected	Amps
24	Front Sensor Camera*	(5 A)
25	Driver's Door Lock	(10 A)
26	Right Side Door Unlock	10 A
27	Rear Right Side Power Window	(20 A)
28	Driver's Power Window	20 A
29	Front Accessory Power Socket	20 A
30	Keyless Entry* ¹ STS* ²	(10 A) (5 A)
31	Driver's Power Seat Reclining*	(20 A)
32	Front Seat Heater*	(20 A)
33	Driver's Power Seat Sliding*	(20 A)
34	VSA/ABS	10 A
35	SRS	10 A
36	–	–
37	Option	(10 A)
38	Left Side Rear Door Lock	(10 A)
39	Driver's Door Unlock	(10 A)

*1: Models with keyless access system
 *2: Models without keyless access system
 *3: Continuously variable transmission models

Models with Idling stop system

Located under the dashboard. Fuse locations are shown on the image below. Locate the fuse in question by the fuse number in the image and chart.

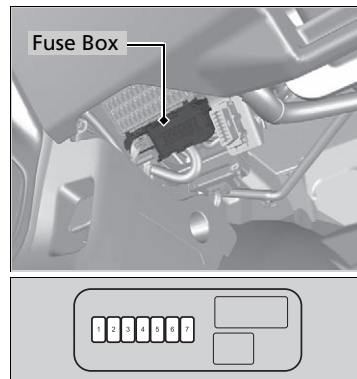

■ Circuit protected and fuse rating

	Circuit Protected	Amps
1	ACC	10 A
2	EOP	10 A
3	Back Up2 Main	10 A
4	Audio VST	15 A
5	ACC OUT	10 A
6	IG1 Relay	10 A
7	Stop Switch 2	5 A

Models with fuse label

Located under the dashboard.

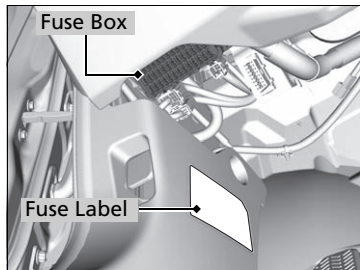

Fuse locations are shown on the label on the side panel.

Locate the fuse in question by the fuse number and label number.

■ Circuit protected and fuse rating

	Circuit Protected	Amps
1	Accessory	10 A
2	Key Lock	(5 A)
3	–	(10 A)
4	Front Sensor Camera* ¹ Transmission* ²	(5 A) (10 A)
5	Option	(10 A)
6	SRS Indicator	(10 A)
7	Meter	10 A
8	Fuel Pump	15 A

* Not available on all models

	Circuit Protected	Amps
9	AIRCON	10 A
10	–	(20 A)
11	IG1 Monitor	5 A
12	Right Side Door Lock	10 A
13	Left Side Rear Door Unlock	10 A
14	Rear Left Side Power Window	(20 A)
15	Front Passenger's Side Power Window	20 A
16	Door Lock	20 A
17	Transmission* ¹ Front Sensor Camera* ²	(10 A) (5 A)
18	–	(10 A)
19	Sunroof*	(20 A)
20	IG1 Starter	(10 A)
21	ACG	10 A
22	Daytime Running Lights	(10 A)
23	Rear Fog Light*	(10 A)
24	Front Sensor Camera*	(5 A)
25	Driver's Door Lock	(10 A)
26	Right Side Door Unlock	(10 A)
27	Rear Right Side Power Window	(20 A)
28	Driver's Power Window	20 A

	Circuit Protected	Amps
29	Front Accessory Power Socket	20 A
30	Keyless access* ¹ STS* ²	(10 A) (5 A)
31	Driver's Power Seat Reclining*	(20 A)
32	Front Seat Heater*	(20 A)
33	Driver's Power Seat Sliding*	(20 A)
34	VSA/ABS	10 A
35	SRS	10 A
36	–	–
37	Option	(10 A)
38	Left Side Rear Door Lock	10 A
39	Driver's Door Unlock	(10 A)

*1: Models with keyless access system

*2: Models without keyless access system

Inspecting and Changing Fuses

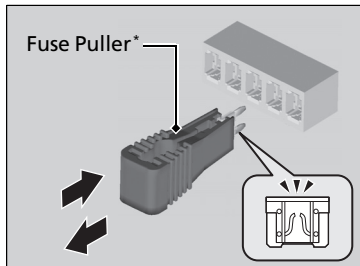
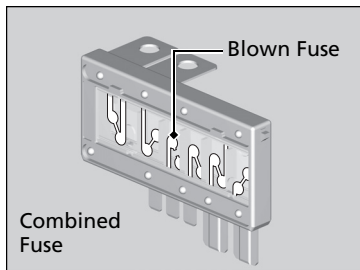

1. Turn the ignition switch to LOCK **0***1. Turn headlights and all accessories off.
2. Remove the fuse box cover.
3. Check the large fuse in the engine compartment.
 - If the fuse is blown, use a Phillips-head screwdriver to remove the screw and replace it with a new one.
4. Inspect the small fuses in the engine compartment and the vehicle interior.
 - If there is a burned out fuse, remove it with the fuse puller* and replace it with a new one.

Inspecting and Changing Fuses

NOTICE

Replacing a fuse with one that has a higher rating greatly increases the chances of damaging the electrical system.

Replace fuse with a spare fuse* or new one of the same specified amperage.

Use the charts to locate the fuse in question and confirm the specified amperage.

► **Fuse Locations** P. 710, 713

There is a fuse puller* on the back of the engine compartment fuse box cover.

*1: Models with the keyless access system have an **ENGINE START/STOP** button instead of an ignition switch.

* Not available on all models

Call a professional towing service if you need to tow your vehicle.

■ Flat bed equipment

The operator loads your vehicle on the back of a truck.

This is the best way to transport your vehicle.

■ Wheel lift equipment

The tow truck uses two pivoting arms that go under the front tyres and lift them off the ground. The rear tyres remain on the ground. **This is an acceptable way to tow your vehicle.**

☒ Emergency Towing

NOTICE

Trying to lift or tow your vehicle by the bumpers will cause serious damage. The bumpers are not designed to support the vehicle's weight.

Never tow your vehicle with just a rope or chain. It is very dangerous since ropes or chains may shift from side to side or break.

■ If your vehicle must be towed with the front wheels on the ground:

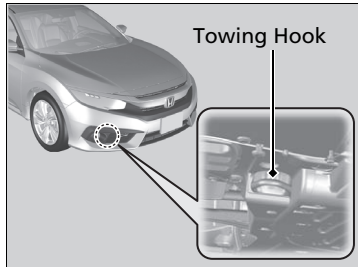

Continuously variable transmission models

1. Check for any fluid leaks on the ground, underneath the transmission housing.
 - ▶ If you find a leak, call a professional towing service and have your vehicle inspected by a dealer.

All models

2. Hook the towing device to the towing hook.

3. Start the engine.

- ▶ If it is difficult to turn on the engine, put the ignition switch in ACCESSORY **I***1 or ON **II***1.

Continuously variable transmission models

4. Depress the brake pedal.
5. Shift to **D** and hold for five seconds, then to **N**.
6. Release the parking brake.

Manual transmission models

4. Shift to **N**.
5. Release the parking brake.

*1: Models with the keyless access system have an **ENGINE START/STOP** button instead of an ignition switch

▶▶ If your vehicle must be towed with the front wheels on the ground:

Towing a vehicle is prohibited by law in some countries. Check and follow the legal requirements of the country you are driving before towing your vehicle.

If you cannot follow the exact procedure, do not tow your vehicle with the front wheels on the ground.

If you cannot turn on the engine, you may experience the following while your vehicle is being towed.

- Braking may become difficult since the brake system's power assist is disabled.
- Steering wheel becomes heavy as the power steering system is disabled.

Manual transmission models

- Turning the ignition switch to LOCK **0***1 locks the steering wheel.

Going down a long slope heats up the brakes. This may prevent the brakes from working properly. If your vehicle needs to be towed on an incline, call a professional towing service.

With the front wheels on the ground, it is best to tow the vehicle no farther than 80 km, and keep the speed below 55 km/h.

NOTICE

Continuously variable transmission models

If you cannot shift the transmission or turn on the engine, will damage the transmission. Your vehicle must be transported with the front wheels off the ground.

When You Cannot Unlock the Fuel Fill Door

If you cannot unlock the fuel fill door, use the following procedure.

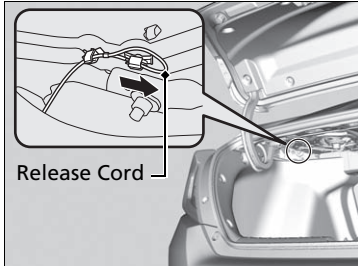

1. Open the boot.
2. Pull the release cord beneath the rear tray to the right.
 - ▶ The release cord unlocks the fuel fill door when it is pulled.

⚠ When You Cannot Unlock the Fuel Fill Door

After taking these steps, contact a dealer to have your vehicle checked.

When You Cannot Open the Boot

If you cannot open the boot, use the following procedure.

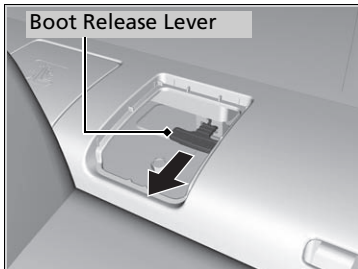
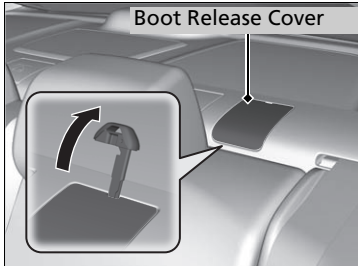

1. Remove the cover with a key.
 - ▶ Wrap a key with a cloth to prevent scratching the cover.
2. Pull the release lever.
3. Replace the cover.

When You Cannot Open the Boot

Following up:

After taking these steps, contact a dealer to have your vehicle checked.

Refueling From a Portable Fuel Container

If you have run out of fuel and need to refuel your vehicle from a portable fuel container, use the funnel provided with your vehicle.

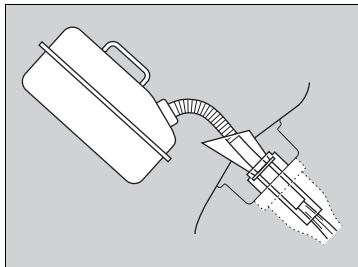
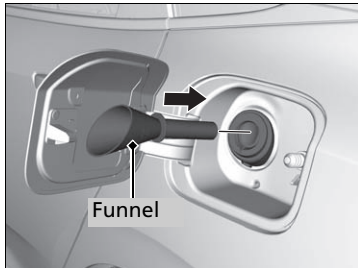

1. Turn off the engine.
2. Press on the edge of the fuel fill door to make it pop up slightly.
 - ▶ The fuel fill door opens.
3. Take the funnel out of the tool case in the boot.
 - ▶ **Types of Tools** P. 674
4. Place the end of the funnel on the lower part of filler opening, then insert it slowly and fully.
 - ▶ Make sure that the end of the funnel goes down along with the filler pipe.
5. Fill the tank with fuel from the portable fuel container.
 - ▶ Pour fuel carefully so you do not spill any.
6. Remove the funnel from the filler neck.
 - ▶ Wipe up any fuel from the funnel before storing it.
7. Shut the fuel fill door by hand.

▶▶ Refueling From a Portable Fuel Container

⚠ WARNING

Petrol is highly flammable and explosive. You can be burned or seriously injured when handling fuel.

- Stop the engine, and keep heat, sparks, and flame away.
- Handle fuel only outdoors.
- Wipe up spills immediately.

NOTICE

Do not insert the nozzle of a portable fuel container or any funnel other than the one provided with your vehicle. Doing so can damage the fuel system. Do not try to pry open or push open the sealed fuel tank with foreign objects. This can damage the fuel system and its seal.

Make sure the fuel in the portable fuel container is petrol before you refuel.

Information

This chapter includes your vehicle's specifications, locations of identification numbers, and other information required by regulation.

Specifications	724
Identification Numbers	
Vehicle Identification Number (VIN), Engine Number and Transmission Number	728
Utility Compliance*	
Devices that Emit Radio Waves	729
EC Declaration of Conformity Content Outline*	732

* Not available on all models

■ Vehicle Specifications

Model	Civic
	1,226 - 1,239 kg ^{*1}
	MT 1,236 - 1,239 kg ^{*2}
	1,279 - 1,321 kg ^{*3}
Curb Weight	1,247 - 1,258 kg ^{*1}
	CVT 1,253 - 1,291 kg ^{*2}
	1,307 - 1,348 kg ^{*3}
Maximum permissible weight	1,313 kg ^{*4}
	1,635 kg ^{*7}
	1,680 kg ^{*5}
Front	1,715 kg ^{*6}
	See the certification label on the driver's doorjamb ^{*8}
	855 kg ^{*7}
Maximum permissible axle weight	885 kg ^{*5}
	910 kg ^{*6}
	See the certification label on the driver's doorjamb ^{*8}
Rear	795 kg ^{*7}
	800 kg ^{*5}
	810 kg ^{*6}
	See the certification label on the driver's doorjamb ^{*8}

- *1: Israeli, Turkish, and except Middle Eastern models with 1.6 L engine
- *2: Middle Eastern except Israeli and Turkish models
- *3: 1.5 L engine models except Turkish
- *4: Turkish models with 1.5 L engine
- *5: Middle Eastern except Israeli and Turkish models without sunroof, with continuously variable transmission
- *6: Middle Eastern except Israeli and Turkish models with sunroof and continuously variable transmission
- *7: Middle Eastern except Israeli and Turkish models with manual transmission
- *8: Israeli, Turkish, and except Middle Eastern models

■ Engine Specifications

Type	Water cooled 4-stroke DOHC VTEC-TURBO in line, 4-cylinder petrol engine ^{*5} Water cooled 4-stroke SOHC VTEC in line, 4-cylinder petrol engine ^{*4}
Bore x Stroke	73.0 x 89.5 mm ^{*5} 81.0 x 77.5 mm ^{*4}
Displacement	1,498 cm ^{3*5} 1,597 cm ^{3*4}
Compression ratio	10.6 : 1 ^{*5} 10.7 : 1 ^{*4}
Max. Power ^{*1}	92 kw (123 HP)/6,500 rpm
Max. Torque ^{*1}	151 N·m (15.4 kgf·m)/4,300 rpm
Max. Speed ^{*1}	203 km/h ^{*2} 195 km/h ^{*3}
Spark Plugs	SILZKR7C11S ^{*4} SILZKR7C11DS ^{*4} ILZKAR8H8S ^{*5}

- *1: GCC country and Iraqi models
- *2: Manual transmission models
- *3: Continuously variable transmission models
- *4: 1.6 L engine models
- *5: 1.5 L engine models

■ Fuel

Fuel Type	Unleaded petrol, Research octane number of 91 or higher ^{*1} Unleaded premium petrol, Research octane number of 95 or higher ^{*2} Unleaded premium petrol/gasohol up to E10 (90% petrol and 10% ethanol), research octane number 95 or higher ^{*3}
Fuel Tank Capacity	46.9 L

- *1: 1.6 L engine models for Middle Eastern except Israeli and Turkish
- *2: 1.6 L engine models for Israeli, Turkish, and except Middle Eastern
- *3: 1.5 L engine models

■ Battery

Capacity/Type	36AH(5)/47AH(20) ^{*1,*2} 48AH(5)/60AH(20) ^{*3} 48AH(5)/60AH(20)/L2 ^{*4}
---------------	--

- *1: 1.6 L engine models
 - *2: Turkish models with 1.5 L engine
 - *3: 1.5 L engine models with continuously variable transmission except Turkish
 - *4: 1.5 L engine models with manual transmission except Turkish
- Idle Stop:
The battery installed in this vehicle is specifically designed for a model with Auto Idle Stop. If you need to replace the battery, make sure to select the specified type. Ask a dealer for more details.

■ Washer Fluid

Tank Capacity	3.5 L
---------------	-------

■ Light Bulbs

Headlights (Low Beam)	55W (H11)* LED*
Headlights (High Beam)	60W (HB3)* LED*
Front Fog Lights*	35 W (H8)* LED*
Front Turn Signal Lights	21 W (Amber)* LED*
Front Side Marker Lights	5 W (Amber)
Position/Daytime Running Lights	LED
Side Turn Signal Lights	LED
Brake Light	21 W
Taillights	LED
Rear Turn Signal Lights	21 W (Amber)
Back-Up Lights	16W
Rear Fog Light*	LED
High-Mount Brake Light	21 W
Rear Licence Plate Lights	LED
Interior Lights	
Map Lights	8 W
Ceiling Light	8 W
Vanity Mirror Lights*	1.8 W
Glove Box Light*	3.4 W
Boot Light	5 W

* Not available on all models

■ Brake/Clutch* Fluid

Specified	Brake Fluid with DOT3 or DOT4	
-----------	-------------------------------	--

■ Continuously Variable Transmission Fluid

Specified	Honda HCF-2 Transmission Fluid	
Capacity	Change	3.5 L ^{*1} 3.7 L ^{*2}

*1: 1.6 L engine models
*2: 1.5 L engine models

■ Manual Transmission Fluid

Specified	Honda Manual Transmission Fluid (MTF)	
Capacity	Change	1.4 L ^{*1} 1.9 L ^{*2}

*1: 1.6 L engine models
*2: 1.5 L engine models

■ Air Conditioning

Refrigerant Type	HFO-1234yf (R-1234yf) ^{*1} HFC-134a (R-134a) ^{*2}	
Charge Quantity	375 - 425 g ^{*1,*2}	

*1: Israeli, Turkish, and except Middle Eastern models
*2: Middle Eastern except Israeli and Turkish models

■ Engine Oil

	1.6 L engine models with service reminder system	
	Genuine Honda Motor Oil ACEA A3/B3, A5/B5 or higher grade 0W-20	
	European models with 1.5 L engine	
	Genuine Honda Motor Oil ACEA A3/B3, A5/B5 or higher grade 0W-20 ^{*3}	
Recommended	Except European models	
	Genuine Honda Motor Oil API service SM or higher grade 0W-20, 0W-30, 5W-30, 10W-30	
	Macedonian, Montenegrin, and Serbian models with 1.6 L engine	
	Genuine Honda Motor Oil ACEA A1/B1,A3/B3,A5/B5 or higher grade 0W-30	
	Change	3.2 L ^{*1} 3.5 L ^{*2}
Capacity	Change including filter	3.5 L ^{*1} 3.7 L ^{*2}

*1: 1.5 L engine models
*2: 1.6 L engine models
*3: If you use 0W-20, you should use "Honda Engine Oil Type 2.0".

■ Engine Coolant

Specified Ratio	Honda All Season Antifreeze/Coolant Type2 50/50 with distilled water
Capacity	4.84 L ^{*1}
	4.92 L ^{*2}
	5.94 L ^{*3}
	5.97 L ^{*4} (change including the remaining 0.58 L in the reserve tank)

*1: 1.5 L engine models with manual transmission

*2: 1.5 L engine models with continuously variable transmission

*3: 1.6 L engine models with manual transmission

*4: 1.6 L engine models with continuously variable transmission

■ Tyre

Regular	Size	215/50R17 91V ^{*1} 215/55R16 93H ^{*2}
	Pressure	See the label on driver's doorjamb.
Compact Spare*	Size	T125/80D16 97M
	Pressure	420 (4.2 [60]) kPa (kgf/cm ² [psi])
Spare* (Full-size tyre)	Size	215/50R17 91V 215/55R16 93H
	Pressure	Same as the regular tyre. See the label on driver's doorjamb.
Wheel Size	Regular	16X7J ^{*2} 17X7J ^{*1}
	Compact Spare*	16X4T
	Full-size Spare*	16X7J ^{*2}
		17X7J ^{*1}

*1: Models with 17 inch wheel

*2: Models with 16 inch wheel

■ Honda TRK Air Compressor^{*1}

A weighted emission sound pressure level	75dB (A)
A weighted sound power level	95dB (A)

*1: Models with tyre repair kit

■ Brake

Type	Power assisted
Front	Ventilated disc
Rear	Solid disc
Parking	Electric Parking Brake

■ Vehicle Dimensions

Length	4,630 mm ^{*1}	
	4,648 mm ^{*2}	
Width	1,799 mm	
Height	1,416 mm ^{*3}	
	1,432.8 mm ^{*4}	
Wheelbase	2,698 mm ^{*2}	
	2,700 mm ^{*1}	
Track	Front	1,543 mm ^{*2,*4}
		1,547 mm ^{*5}
	Rear	1,557 mm ^{*2}
		1,557.1 mm ^{*4}
		1,563 mm ^{*5}

*1: Middle Eastern except Israeli and Turkish models

*2: Israeli, Turkish, and except Middle Eastern models

*3: Except Egyptian models

*4: Egyptian models

*5: Middle Eastern except Egyptian, Israeli and Turkish models

■ **The mounting point/rear over hang of coupling device*1**

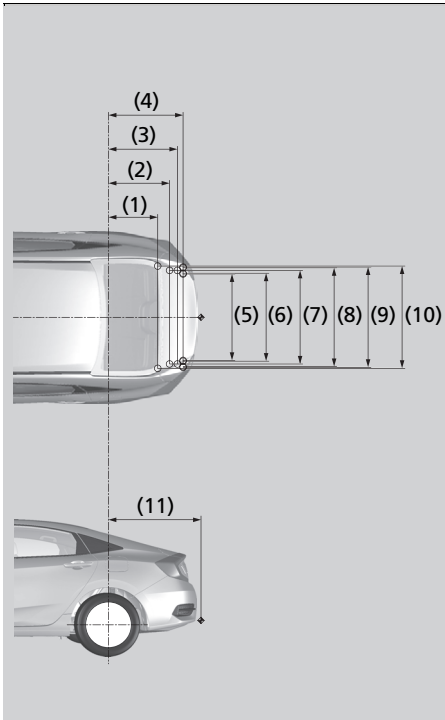

No.	Dimensions
(1)	552 mm (21.7 in)
(2)	675 mm (26.6 in)
(3)	757 mm (29.8 in)
(4)	817 mm (32.2 in)
(5)	915 mm (36.0 in)
(6)	925 mm (36.4 in)
(7)	986 mm (38.8 in)
(8)	1,045 mm (41.1 in)
(9)	1,055 mm (41.5 in)
(10)	1,076 mm (42.4 in)
(11)	1,124 mm (44.3 in)

*1: European and Turkish models

■ **Max. Towing Weight*1**

Trailer with brakes	Manual Transmission Models	1,200 kg (2,646 lbs) ^{*2}
	Continuously Variable Transmission Models	1,400 kg (3,086 lbs) ^{*3}
Trailer without brakes		800 kg (1,764 lbs) ^{*2}
		1,000 kg (2,205 lbs) ^{*3}
Trailer without brakes		500 kg (1,102 lbs)
The maximum permissible vertical load on the coupling device		75 kg (165 lbs)

*1: European and Turkish models

*2: 1.6 L engine models

*3: 1.5 L engine models

NOTE:

1. ○ marks show towbar fixing points.

2. ◆ mark shows towbar coupling point.

Vehicle Identification Number (VIN), Engine Number and Transmission Number

Your vehicle has a 17-digit vehicle identification number (VIN) used to register your vehicle for warranty purposes, and for licensing and insuring your vehicle. The locations of your vehicle's VIN, engine number and transmission number are shown as follows.

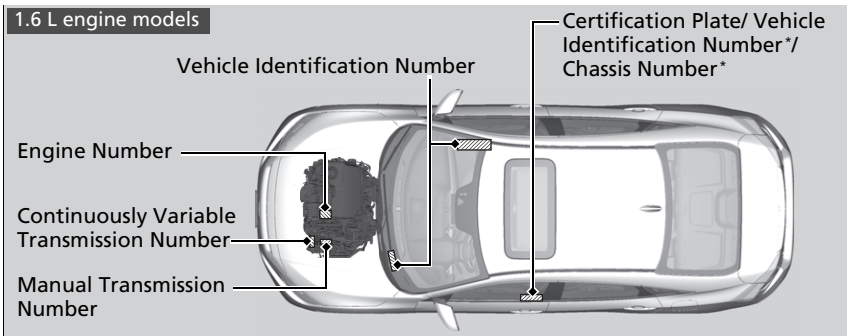
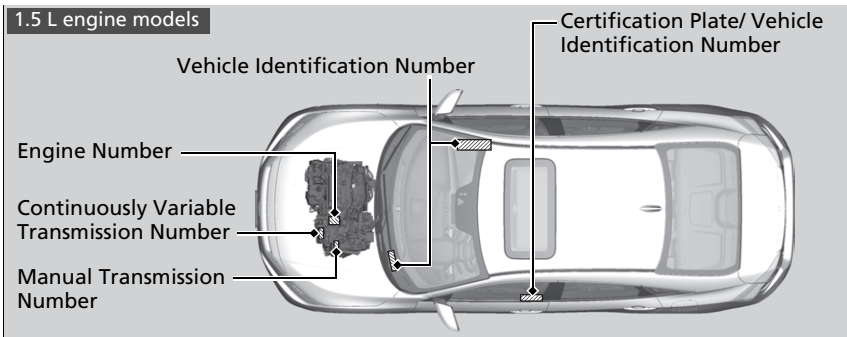

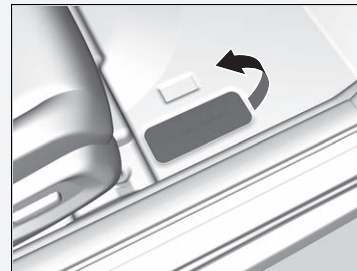

Vehicle Identification Number (VIN), Engine Number and Transmission Number

The interior vehicle identification number (VIN) is located under the cover.



Devices that Emit Radio Waves

The following products and systems on your vehicle emit radio waves when in operation.

	Remote Transmitter*	Immobilizer System	Keyless Access System*
European models			

U.A.E. models

TRA
REGISTERED No:
ER0122948/13
DEALER No:
DA0046049/10

TRA
REGISTERED No:
ER0108496/13
DEALER No:
DA0046049/10

TRA
REGISTERED No:
ER0104988/13
DEALER No:
DA0039841/10

TRA
REGISTERED No:
ER39254/15
DEALER No:
DA36975/14

KEY

BCM

Serbian models

—

—



or



Devices that Emit Radio Waves

European models

Models with remote transmitter

Models with keyless access system

EC Directives

Each of the items in the table complies with the essential requirements and other relevant provisions of R & TTE (Radio equipment and Telecommunications Terminal Equipment and the mutual recognition of their conformity) Directive 1999/5/EC.

See the following URLs for Declaration of conformity:
<http://www.techinfo.honda-eu.com>

* Not available on all models

Continued

Keyless Access System*

Israeli models

א. השימוש במכשיר הינו על בסיס "משני" ופטור מרשיון הפעלה אלחוטי.
 כלומר – לא מוגן מהפרעות וולא הפרעה למערכות אחרות הפועלות כדין.
 ב. רק "בפעולת בזק" לשימוש עצמי של הלקוח בלבד, הצידוד פטור מרשיון הפעלה אלחוטי.
 מתן "שרות בזק" לצד ג' מחייב רשיון מיוחד ממשרד התקשורת.
 ג. אסור להחליף את האנטנה המקורית של המכשיר, וולא לעשות בו כל שינוי טכני אחר.

Hands-Free Telephone

Adaptive Cruise Control (ACC) with Low Speed Follow (LSF)* / Adaptive Cruise Control (ACC)* / Collision Mitigation Braking System (CMBS)*

European models



U.A.E. models

TRA
 REGISTERED No:
 ER0126813/14
 DEALER No:
 DA0047813/10

–

Serbian models



or



–

►► Devices that Emit Radio Waves

European models

Models with Hands-Free Telephone System

Models with Adaptive Cruise Control/Collision Mitigation Braking System

EC Directives

Each of the items in the table complies with the essential requirements and other relevant provisions of R & TTE (Radio equipment and Telecommunications Terminal Equipment and the mutual recognition of their conformity) Directive 1999/5/EC.

See the following URLs for Declaration of conformity:
<http://www.techinfo.honda-eu.com>

Hands-Free Telephone					
Israeli models	<table border="1"> <thead> <tr> <th>Models with colour audio system</th> <th>Models with Display Audio</th> </tr> </thead> <tbody> <tr> <td>  </td> <td> <p>א. מקובל לניסוח חלון הליקוי או ררך לתיכור משתמש המכיר התכנים תחומיים וזוגות בית, בית עסק, תורגם שיה העשות קמפוט ואינטיטיטאו וכי ב. לצורך גישה לאינטרנט, נקודות גישה תקשורת טווח לזכרים או ררך אל ככל רישיון למתן שירותי גישה לאינטרנט (ISP) חלקי-עסק ואינטרנט, הקישור לטקס אינטרנט וידוע אך ררך באמצעות נט וגישה לרשתות מקומיות כדוגמת כלי ככל רישיון למתן שירותי תקשורת ג. קישור נקודות גישה לזכרים לצורך תקשורת נתונים הישג באמצעות חשבונית של ככל רישיון טלפון ד. לצורך שירות כדוגמה נדרש רישיון טקס מאגן הגנה ורישיון למסדר התקשורת.</p> </td> </tr> </tbody> </table>	Models with colour audio system	Models with Display Audio		<p>א. מקובל לניסוח חלון הליקוי או ררך לתיכור משתמש המכיר התכנים תחומיים וזוגות בית, בית עסק, תורגם שיה העשות קמפוט ואינטיטיטאו וכי ב. לצורך גישה לאינטרנט, נקודות גישה תקשורת טווח לזכרים או ררך אל ככל רישיון למתן שירותי גישה לאינטרנט (ISP) חלקי-עסק ואינטרנט, הקישור לטקס אינטרנט וידוע אך ררך באמצעות נט וגישה לרשתות מקומיות כדוגמת כלי ככל רישיון למתן שירותי תקשורת ג. קישור נקודות גישה לזכרים לצורך תקשורת נתונים הישג באמצעות חשבונית של ככל רישיון טלפון ד. לצורך שירות כדוגמה נדרש רישיון טקס מאגן הגנה ורישיון למסדר התקשורת.</p>
Models with colour audio system	Models with Display Audio				
	<p>א. מקובל לניסוח חלון הליקוי או ררך לתיכור משתמש המכיר התכנים תחומיים וזוגות בית, בית עסק, תורגם שיה העשות קמפוט ואינטיטיטאו וכי ב. לצורך גישה לאינטרנט, נקודות גישה תקשורת טווח לזכרים או ררך אל ככל רישיון למתן שירותי גישה לאינטרנט (ISP) חלקי-עסק ואינטרנט, הקישור לטקס אינטרנט וידוע אך ררך באמצעות נט וגישה לרשתות מקומיות כדוגמת כלי ככל רישיון למתן שירותי תקשורת ג. קישור נקודות גישה לזכרים לצורך תקשורת נתונים הישג באמצעות חשבונית של ככל רישיון טלפון ד. לצורך שירות כדוגמה נדרש רישיון טקס מאגן הגנה ורישיון למסדר התקשורת.</p>				

Blind spot information System*/Cross Traffic Monitor*	
European models	

►► Devices that Emit Radio Waves

European models

Models with Blind spot information System/Cross Traffic Monitor

EC Directives Each of the items in the table complies with the essential requirements and other relevant provisions of R & TTE (Radio equipment and Telecommunications Terminal Equipment and the mutual recognition of their conformity) Directive 1999/5/EC.

See the following URLs for Declaration of conformity:
<http://www.techinfo.honda-eu.com>

* Not available on all models

EC Declaration of Conformity



1. The undersigned, Mr. Ryoichi Hiraki, representing the manufacturers, herewith declares that the machinery described below fulfils all the relevant provisions of:

- The EC-directive 2006/42/EC on machinery

2. Description of the machinery

a) Generic denomination: Pantograph jack
 b) Function: lifting motor vehicle

c) Model	d) Type
SNB	Honda Type-A
SJD	Honda Type-B
SZA	Honda Type-C
SAH	Honda Type-D
TP6	Honda Type-G
T5A	Honda Type-I
T2V	Honda Type-J

3. Manufacturer (1) : Honda Type-A/B/C/G/I
 RIKENKAKI CO., LTD.
 5-6-12 Chiyoda Sakado-shi,
 Saitama 350-0214
 JAPAN

4. Manufacturer (2) : Honda Type-D/J
 CHANGZHOU RIKENSEIKO MACHINERY CO., LTD.
 No. 1903 Zhongwu Ave. Zhonglou Changzhou,
 Jianosu CHINA

5. Legal person authorised to compile the technical file :
 Honda Motor Europe Ltd Belgian Branch
 p/a Honda Motor Europe Ltd – Aalst Office
 Wjingaardveld 1 (Noord V)
 B-9300 Aalst (Belgium)

6. References to harmonized standards	7. Other standards or specifications
EN1494:2000+A1:2008	-

8. Done at: Saitama, Japan
 9. Date: 1 December,2009

Ryoichi Hiraki

Ryoichi Hiraki
 President of RIKENKAKI CO., LTD.
 President of CHANGZHOU RIKENSEIKO
 MACHINERY CO.,LTD.

Note: This declaration becomes invalid, if technical or operational modifications are introduced without the manufacturers consent.

Numbers

7-Speed Manual Shift Mode 472

A

AAC 280, 329

ABS (Anti-lock Brake System) 566

ACC (Adaptive Cruise Control) 518

Accessories and Modifications 671

Accessory Power Socket 237

Adaptive Cruise Control (ACC) 518

Adaptive Cruise Control (ACC) with Low
Speed Follow (LSF) 120, 503

Adding

Coolant 627

Engine Oil 626

Washer 632

Additives, Engine Oil 621

Adjustable Speed Limiter 490

Adjusting

Armrest 230

Front Head Restraints 226

Front Seats 222, 223

Headlights 211

Mirrors 220

Rear Seats 229

Steering Wheel 219

Temperature 154, 158

Adjusting the Sound 266, 308

Agile Handling Assist System 552

Aha™ 328

Air Conditioning System (Climate

Control System) 244

Changing the Mode 246

Defrosting the Windscreen and
Windows 247

Dust and Pollen Filter 664

Recirculation/Fresh Air Mode 246

Sensors 250

Synchronized Mode 249

Using Automatic Climate Control 244

Air Pressure 726

Airbags 52

After a Collision 55

Airbag Care 65

Event Data Recorder 1

Front Airbags (SRS) 54

Indicator 63, 101

Passenger Airbag Off Indicator 64

Sensors 52

Side Airbag 59

Side Curtain Airbag 61

AM/FM Radio 268, 315

Android Auto 346

Anti-lock Brake System (ABS) 566

Indicator 100

Apple CarPlay 343

Armrest 230

Audio Remote Controls 257

Audio System 252

Adjusting the Sound 266, 308

Aha™ 328

AM/FM Radio 268, 315

Android Auto 346

Apple CarPlay 343

Audio/Information Screen 262, 287

Bluetooth® Audio 283, 332

Changing the Home Screen Icon Layout .. 291

Changing the Screen Interface 305

Closing Apps 307

Customizing the Meter 291

DAB 274, 318

Display Setup 267, 309

Error Messages 350

General Information 353

HDMI™ 334

HDMI™ Port 255

Home Screen 297

iPod 277, 321

Menu Customize 306

MP3/WMA/AAC 280, 329

MP4 329

On Board Apps 336

Reactivating 256

Recommended Devices 354

Remote Controls 257

Security Code 256

Selecting an Audio Source 310

Siri Eyes Free 342

Smartphone Connection 337

Status Area 304

Switching the Display 262, 287

Theft Protection 256

USB Flash Drive.....	280, 329
USB Port(s).....	253
Wallpaper Setup.....	264, 295
WAV.....	329
Wi-Fi Connection.....	340
Audio/Information Screen.....	262, 287
Auto High-Beam (High Beam Support System).....	208
Auto Idle Stop.....	478
Auto Idle Stop OFF Button.....	479
Automatic Brake Hold.....	563
Indicator.....	96, 563
Automatic Brake Hold System Indicator.....	95
Automatic Lighting.....	204
Average Fuel Economy.....	153, 157
Average Speed.....	157

B

Backup Sensor System.....	583
Battery.....	656
Charging System Indicator.....	97, 702
Jump Starting.....	695
Maintenance (Checking the Battery).....	656
Maintenance (Replacing).....	658, 661
Belts (Seat).....	40
Beverage Holders.....	235
Blind Spot Information (BSI) System.....	553
Bluetooth® Audio.....	283, 332
Booster Seats (For Children).....	88

Boot.....	186
Lid.....	186
Light Bulb.....	644
Release Lever.....	720
Unable to Open.....	720
Brake System.....	560
Anti-lock Brake System (ABS).....	566
Automatic Brake Hold.....	563
Brake Assist System.....	567
Fluid.....	631
Foot Brake.....	562
Indicator.....	94
Parking Brake.....	560
Brightness Control (Instrument Panel)....	216
BSI (Blind Spot Information) System.....	553
Bulb Replacement.....	634
Boot Light.....	644
Brake Light, Taillight, Rear Turn Signal Light, Rear Fog Light and Back-Up Light Bulbs.....	641
Ceiling Light.....	643
Front Fog Lights.....	636
Front Side Marker Lights.....	639
Front Turn Signal Lights.....	638
Glove Box Light.....	645
Headlights.....	634
High-Mount Brake Light.....	642
Interior Lights.....	643
Map Light.....	643
Position/Daytime Running Lights.....	640
Rear Licence Plate Light.....	642

Side Turn Signal/Emergency Indicator Lights.....	640
Taillights.....	642
Vanity Mirror.....	644
Bulb Specifications.....	725

C

Carbon Monoxide Gas.....	90
Carrying Luggage.....	449, 451
Certification Label.....	728
Changing Bulbs.....	634
Charging System Indicator.....	97, 702
Child Restraint System.....	66
Booster Seats.....	88
Child Restraint System for Infants.....	69
Child Restraint System for Small Children..	71
Installing a Child Restraint System with a Lap/Shoulder Seat Belt.....	83
Larger Children.....	87
Rear-facing Child Restraint System.....	69
Selecting a Child Restraint System.....	72
Using Tether.....	86
Child Safety.....	66
Childproof Door Locks.....	185
Cleaning the Exterior.....	668
Cleaning the Interior.....	666
Climate Control System.....	244
Changing the Mode.....	244
Defrosting the Windscreen and Windows.....	247

Dust and Pollen Filter	664
Recirculation/Fresh Air Mode.....	246
Sensors.....	250
Synchronized Mode.....	249
Using Automatic Climate Control.....	244
Clock	170
Coat Hooks.....	240
Collision Mitigation Braking System (CMBS)	569
Console Compartment.....	234
Continuously Variable Transmission	467
Creeping.....	467
Kickdown	467
Operating the Shift	
Lever.....	25, 468, 469, 470, 471
Shift Lever Does Not Move.....	698
Shifting.....	468, 470
Controls	169
Coolant (Engine)	627
Adding to the Radiator	628, 629
Adding to the Reserve Tank	627
Overheating.....	699
Creeping (Continuously Variable Transmission).....	467
Cross Traffic Monitor	585
Cruise Control	484, 487
Indicator.....	112
Cup Holders.....	235
Customized Features	359

D

DAB	274, 318
Daytime Running Lights.....	212
Dead Battery.....	695
Defaulting All the Settings	393
Deflation Warning System	556
Calibration	556
Indicator.....	106, 107
Defrosting the Windscreen and Windows	247
Devices that Emit Radio Waves	729
Dimming	
Headlights	202
Dipstick (Engine Oil)	624
Directional Signals (Turn Signal)	202
Display Setup	267, 309
Display/Information Button	155, 287
Door Mirrors	221
Doors	173
Door Open Indicator.....	39, 105
Keys	173
Locking/Unlocking the Doors from the Inside.....	184
Locking/Unlocking the Doors from the Outside.....	176
Lockout Prevention System	183
Driver Information Interface	155
Driving.....	447
Braking.....	560
Continuously Variable Transmission	467
Cruise Control	484, 487

Shifting Gear.....	468, 470, 475
Starting the Engine.....	458, 461
Dust and Pollen Filter.....	664

E

Eco Assist System	9
ECON Button	483
Elapsed Time.....	157
Electric Power Steering (EPS) System	
Indicator.....	105, 706
Emergency	717
Emergency Stop Signal	568
Engine	
Coolant.....	627
Jump Starting.....	695
Number.....	728
Oil.....	621
Starting.....	458, 461
Switch Buzzer.....	197
Engine Coolant.....	627
Adding to the Radiator.....	628, 629
Adding to the Reserve Tank.....	627
Overheating	699
Engine Oil	621
Adding.....	626
Checking.....	624
Low Oil Level Indicator	709
Low Oil Pressure Indicator	96, 702
Recommended Engine Oil	621
Engine Start/Stop Button.....	198

EPS (Electric Power Steering)	
System.....	105, 706
Exhaust Hazard (Carbon Monoxide)	90
Exterior Care (Cleaning).....	668
Exterior Mirrors.....	221

F

Features.....	251
Filter	
Dust and Pollen	664
Flat Tyre.....	675
Floor Mats	667
Fluid	
Continuously Variable Transmission	630
Fluids	
Brake/Clutch.....	631
Engine Coolant.....	627
Manual Transmission	630
Windscreen Washer.....	632
FM/AM Radio	268, 315
Folding Down the Rear Seats.....	229
Foot Brake.....	562
Front Airbags (SRS).....	54
Front Fog Light Indicator	108
Front Head Restraints.....	226
Front Seat Heaters	242
Front Seats	222
Adjusting.....	222, 223
Front Sensor Camera	501

Fuel.....	27, 591
Fuel Economy and CO ₂ Emissions	594
Gauge.....	151
Instant Fuel Economy	157
Low Fuel Indicator	100
Range	153, 157
Recommendation	591
Refueling.....	591
Fuel Economy and CO ₂ Emissions	594
Fuel Fill Door	27, 592
Fuses.....	710
Inspecting and Changing.....	716
Locations.....	710, 713

G

Gauges.....	151
Gear Shift Lever Positions	
Continuously Variable	
Transmission.....	468, 470
Manual Transmission.....	475
Glass (care).....	666, 669
Glove Box.....	233

H

Halogen Bulbs	634, 636
Hands-Free Telephone System	394, 415
Automatic Import of Cellular Phonebook	
and Call History	427
Displaying Messages.....	442

HFT Buttons	394, 415
HFT Menus	396, 418
HFT Status Display.....	395, 417
Making a Call	411, 436
Options During a Call.....	414, 439
Phone Setup	400, 422
Phonebook Phonetic Modification.....	431
Receiving a Call.....	413, 439
Receiving a Text Message/E-mail	440
Ring Tone	406, 426
Selecting a Mail Account.....	441
Speed Dial	409, 428
To Set Up Text Message/E-mail Options ..	425
Hazard Warning Button	4
HDMI™ Port	255
Headlights	202
Adjuster.....	211
Aiming.....	634
Auto High-Beam (High Beam Support	
System).....	208
Automatic Operation	204
Dimming.....	202, 212
Operating	202
Heated Door Mirrors	218
Heaters (Front Seat).....	242
Heaters (Seat).....	243
HFT (Hands-Free Telephone	
System).....	394, 415
High Beam Indicator	108
Honda TRK	683

I	
Identification Numbers	728
Engine and Transmission.....	728
Vehicle Identification.....	728
Ignition Switch	197
Illumination Control	216
Knob.....	216
Immobilizer System	189
Indicator.....	110
Indicators	94
ABS (Anti-lock Brake System).....	100
Adaptive Cruise Control (ACC) with Low Speed Follow (LSF).....	120, 503
Automatic Brake Hold.....	96, 563
Blind Spot Information (BSI).....	555
Brake Depressing.....	117
Charging System.....	97
Collision Mitigation Braking System (CMBS).....	123, 124
Cruise Control.....	112, 485
Cruise Main.....	112, 484
Door Open.....	105
ECON Mode.....	111
EPS (Electric Power Steering) System.....	105
Front Fog Light.....	108
High Beam.....	108
Immobilizer System.....	110
Keyless Access System.....	111
Lane Keeping Assist System (LKAS).....	121, 545
Light Control.....	109
Lights On.....	108
Low Fuel.....	100
Low Oil Pressure.....	96
Low Tyre Pressure/Deflation Warning System.....	106, 107
Malfunction Indicator Lamp.....	97
Parking Brake and Brake System.....	94
Parking Brake and Brake System (Amber)...	95
Passenger Front Airbag On/Off.....	102
Rear Fog Light.....	108
Road Departure Mitigation.....	118, 119
Rotate Wheel.....	114
Seat Belt Reminder.....	99
Security System Alarm.....	110
Shift Lever Position.....	98
Shift to Park.....	114
Speed Alarm.....	111
Speed Limiter.....	112
Supplemental Restraint System.....	101
System Message.....	107
Transmission.....	98
Transmission Temperature.....	105
Turn Signal and Hazard Warning.....	108
VSA (Vehicle Stability Assist) system.....	103
VSA OFF.....	104, 551
Instrument Panel	93
Brightness Control.....	216
Intelligent Speed Limiter	494
Interior Lights	231
Interior Rearview Mirror	220
iPod	277, 321

J	
Jack (Wheel Nut Wrench)	678
Jump Starting	695

K	
Key Number Tag	174
Keys	173
Keys.....	173
Number Tag.....	174
Rear Door Won't Open.....	185
Remote Transmitter.....	180
Types and Functions.....	173
Won't Turn.....	30
Kickdown (Continuously Variable Transmission)	467

L	
Lane Keeping Assist System (LKAS)	543
Language (HFT)	395, 417
Lights	202, 634
Automatic.....	204
Bulb Replacement.....	634
Daytime Running Lights.....	212
Fog Lights.....	206
High Beam Indicator Light.....	108
Interior.....	231
Light Control Indicator.....	109
Light Switches.....	202
Lights On Indicator.....	108

Turn Signals.....	202
Load Limits	451
Locking/Unlocking	173
Childproof Door Locks.....	185
From Inside.....	184
From Outside.....	176
Keys.....	173
Using a Key.....	182
Low Battery Charge	702
Low Fuel Indicator	100
Low Oil Pressure Indicator	702
Lower Anchorages	79
Lubricant Specifications Chart	725
Luggage (Load Limit)	451
Lumbar Support	224

M

Maintenance	597
Battery.....	656
Brake/Clutch Fluid.....	631
Cleaning.....	666
Coolant.....	627
Oil.....	624
Precautions.....	598
Radiator.....	628, 629
Remote Transmitter.....	661
Replacing Light Bulbs.....	634
Safety.....	599
Transmission Fluid.....	630
Tyres.....	649

Under the Bonnet.....	617
Malfunction Indicator Lamp	97, 703
Manual Transmission	475
Map Lights	232
Maximum Permissible Weight	451
Meters, Gauges	151
Mirrors	220
Adjusting.....	220
Door.....	221
Exterior.....	221
Interior Rear View.....	220
Modifications (and Accessories)	671
MP3	280, 329
MP4	329
Multi-View Rear Camera	589

N

Numbers (Identification)	728
---------------------------------------	-----

O

Odometer	152, 156
Oil (Engine)	621
Adding.....	626
Checking.....	624
Low Oil Level Indicator.....	709
Low Oil Pressure Indicator.....	96, 702
Oil Monitor System.....	606
Recommended Engine Oil.....	621
Viscosity.....	621

On Board Apps	336
Open Source Licences	357
Opening	
Boot.....	720
Opening/Closing	
Bonnet.....	619
Boot.....	186
Power Windows.....	192
Sunroof.....	196
Outside Temperature Display	158, 161
Overheating	699

P

Paddle Shifters (7-Speed Manual Shift Mode)	25, 472, 473
Parking Brake	560
Parking Brake and Brake System Indicator (Amber)	95
Parking Brake and Brake System Indicator (Red)	94
Parking Sensor System	579
Passenger Airbag Off Indicator	64
Passing Indicators	202
Petrol	27, 591
Fuel Economy and CO ₂ Emissions.....	594
Gauge.....	151
Information.....	591
Instant Fuel Economy.....	157
Low Fuel Indicator.....	100
Refueling.....	591

Precautions While Driving	466
Rain	466
Pregnant Women	49
Puncture (Tyre)	675

R

Radiator	628, 629
Radio (FM/AM)	268, 315
Radio Data System (RDS)	269, 317
RDS (Radio Data System)	269, 317
Rear Demister/Heated Door Mirror	
Button	218
Rear Fog Light Indicator	108
Rear Seat Heaters	243
Rear Seats (Folding Down)	229
Rear View Mirror	220
Refueling	591
Fuel Gauge	151
Low Fuel Indicator	100
Petrol	591, 724
Regulations	729
Remote Transmitter	180
Replacement	
Battery	658, 661
Bulbs	634
Fuses	710, 713
Tyres	675
Wiper Blade Rubber	646
Resetting a Trip Meter	153, 157

Road Departure Mitigation	532
On and Off	533

S

Safe Driving	35
Safety Check	39
Safety Labels	91
Safety Message	0
Seat Belts	40
Adjusting the Shoulder Anchor	48
Checking	50
Fastening	46
Installing a Child Restraint System with a	
Lap/Shoulder Seat Belt	83
Pregnant Women	49
Reminder	43
Warning Indicator	43, 99
Seat Heaters	243
Seats	222
Adjusting	222
Front Seat Heaters	242
Front Seats	222
Rear Seats	229
Seat Heaters	243
Security System	189
Immobilizer System Indicator	110
Security System Alarm Indicator	110
Select Lever	468, 470, 475
Operation	468, 470, 475
Releasing	698

Won't Move	698
Selecting a Child Restraint System	72
Service Reminder System	601
Setting the Clock	170
Shift Lever	468, 470, 475
Shift Lever Position Indicator	98, 469, 471
Shifting (Transmission)	468, 470, 475
Shoulder Anchor	48
Side Airbags	59
Side Curtain Airbag	61
Siri Eyes Free	342
Smartphone Connection	337
Song By Voice™ (SBV)	324
Spare Tyre	675, 726
Spark Plugs	724
Specifications	724
Specified Fuel	591
Speed Alarm Indicator	111
Speed Limiter, Adjustable	490
Speed Limiter, Intelligent	494
Speedometer	151
SRS Airbags (Airbags)	54
Start/Stop Button	198
Starting the Engine	458, 461
Does Not Start	692
Engine Switch Buzzer	197
Jump Starting	695
Steering Wheel	219
Adjusting	219
Stopping	578
Sunroof	196

Supplemental Restraint System (SRS).....	54
Switches (Around the Steering Wheel)	4, 5, 197
System Message Indicator	107

T

Tachometer	151
Temperature	
Outside Temperature Display	158, 161
Temperature Sensor	154, 158, 250
Temporary Repair Kit (TRK)	683
Time (Setting)	170
Tools	674
Towing a Trailer	
Equipment and Accessories	454
Load Limits	452
Towing Your Vehicle	
Emergency.....	717
Traffic Sign Recognition System	536
Small Icons On and Off	542
Transmission.....	468, 470, 475
7-Speed Manual Shift Mode	472
Continuously Variable	
Transmission	468, 470
Fluid	630
Manual.....	475
Number	728
Shift Lever Position Indicator	98, 469, 471
Temperature Indicator	105
TRIP Knob.....	152, 156

Trip Meter	153, 156
TRK (Temporary Repair Kit)	683
Troubleshooting.....	673
Blown Fuse.....	710, 713
Brake Pedal Vibrates	30
Buzzer Sounds When Opening Door.....	31
Emergency Towing.....	717
Engine Won't Start.....	692
Noise When Braking.....	32
Overheating	699
Puncture/Flat Tyre.....	675, 683
Rear Door Won't Open.....	31
Select Lever Won't Move.....	698
Warning Indicators	94
Turn Signals	202
Turn signals	
Indicators (Instrument Panel)	108
Turn-by-Turn Directions	160
Tyres	649
Air Pressure	726
Checking and Maintaining	649
Inspection	649
Puncture (Flat Tyre).....	675
Rotation	652
Spare Tyre	675, 726
Temporary Repair Kit (TRK).....	683
Tyre Chains	654
Wear Indicators	650
Winter.....	654

U

Unlocking the Doors.....	176
Unlocking the Front Doors from the Inside.....	184
USB Flash Drive	280, 329
USB Port(s).....	253
Using the Keyless Access System	176

V

Vanity Mirrors	7
Vehicle Identification Numbers	728
Vehicle Stability Assist (VSA)	550
OFF Indicator	104
Off Switch	551
System Indicator	103
Viscosity (Oil).....	621, 725
Voice Control Operation	311
Audio Commands.....	313
Climate Control Commands.....	314
General Commands	314
Music Search Commands.....	314
On Screen Commands	314
Phone Commands	313
Useful Commands	313
Voice Portal Screen	312
Voice Recognition	311
VSA (Vehicle Stability Assist)	550

W

- Wallpaper..... 264, 295
- Warning and Information
 - Messages..... 125, 126
- Warning Indicator On/Blinking..... 702
- Warning Labels 91
- Watts 725
- WAV..... 329
- Wear Indicators (Tyre) 650
- Wheel Nut Wrench (Jack Handle)..... 678
- Wi-Fi Connection 340
- Window Washers 213
 - Adding/Refilling Fluid 632
 - Switch 213
- Windows (Opening and Closing) 192
- Windscreen..... 213
 - Cleaning 666, 669
 - Defrosting/Defogging 247
 - Washer Fluid..... 632
 - Wiper Blades..... 646
 - Wipers and Washers 213
- Winter Tyres 654
 - Tyre Chains..... 654
- Wipers and Washers 213
 - Checking and Replacing Wiper Blades..... 646
- Wireless Charger 238
- WMA..... 280, 329
- Worn Tyres 649

